

RADIO - ELECTRONICS

SEPTEMBER 1954

TELEVISION • SERVICING • HIGH FIDELITY

HUGO GERNSBACK, Editor

In this issue:

TV Antenna
Repairs

•

Vertical
Interlace and
Instability

•

Electronic
Photoflash

•

Tape Recorder
Problems

•

Sensitive
Pin-Jack
Multimeter



35¢

U. S. and
CANADA

Modifying Marine Radiophones—
New Opportunities for the Technician (See page 4)

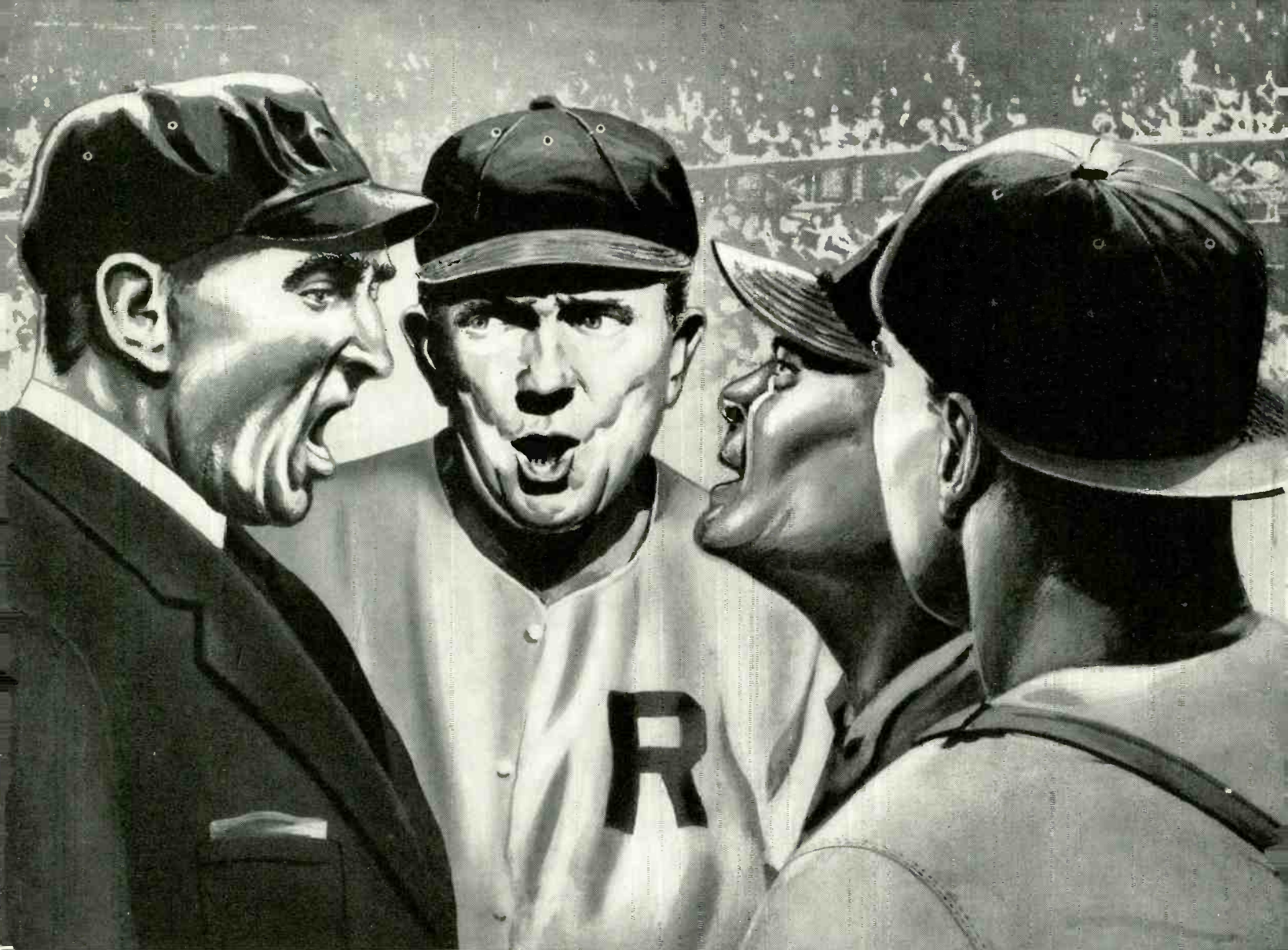

avoid "RHUBARBS"

The key to successful servicing is a satisfied customer. In television servicing, customer satisfaction is assured only when your highly technical knowledge is employed with components that meet or exceed performance expectations. Taking chances with components of questionable quality leads eventually to "rhubarbs" with dissatisfied customers. Nothing can be more harmful to the future of your television servicing business.

Always back up your quality work with dependable component parts. You can depend on Du Mont quality picture tubes to do more for your service.



Replacement Sales, Cathode Ray Tube Division
Allen B. Du Mont Laboratories, Inc., Clifton, N. J.

PIONEER IN BIG PICTURE TUBES • ORIGINATOR OF THE FAMOUS BENT-GUN AND SELFOCUS •
LEADER IN HIGH RESOLUTION • MAJOR SUPPLIER TO MOST FINE TELEVISION RECEIVER MANUFACTURERS

*Trade-mark

Here's a NEW Way to Reach the Top in TV SERVICING

**All-practice method—
professional techniques,
skills, knowledge of
circuits, etc.**



Includes 17" picture tube, all other tubes, components for a TV Receiver, Scope, Signal Generator, HF Probe. Low Introductory price under \$200, on easy terms. Mail Coupon today.

IF YOU HAVE some Radio or Television experience, or if you know basic Radio-Television principles but lack experience—NRI's new Professional Television Servicing course can train you to go places in TV servicing. This advertisement is your personal invitation to get a free copy of our booklet which describes this training in detail.

LEARN-BY-DOING "ALL THE WAY"

This is 100% learn-by-doing, practical training. We supply *all* the components, *all* tubes, including a 17-inch picture tube, and comprehensive manuals covering a thoroughly planned program of practice. You learn how experts diagnose TV receiver defects quickly. You see how various defects affect the performance of a TV receiver—picture and sound; learn to know the causes of defects, accurately, easily, and how to fix them. You do more than just build circuits. You get practice recognizing, isolating, and fixing innumerable TV receiver troubles.

You get actual experience aligning TV receivers, diagnosing the causes of complaints from scope patterns, eliminating interference, using germanium crystals to rectify the TV picture signal, obtaining maximum brightness and definition by properly adjusting the ion trap and centering magnets, etc. There isn't room on this or even several pages of this magazine to list all the servicing experience you get.

UHF AND COLOR TV MAKING NEW BOOM

Installing front-end channel selector strips in modern UHF-VHF Television receivers and learning UHF servicing problems and their solution is part of the practice you get if you live in a UHF area. To cash in on the coming color TV boom you'll need the kind of knowledge and experience which this training gives.

GET DETAILS OF NEW COURSE FREE

Once again—if you want to go places in TV servicing, we invite you to find out what you get, what you practice, what you learn from NRI's new course in Professional Television Servicing. See pictures of equipment supplied, read what you practice. Judge for yourself whether this training will further your ambition to reach the top in TV servicing. We believe it will. We believe many of tomorrow's top TV servicemen will be graduates of this training. Mailing the coupon involves no obligation.



**National Radio Institute, Dept. 4JFT
16th and U Sts., N.W., Washington 9, D. C.**

Please send my FREE copy of "How to Reach the Top in TV Servicing." I understand no salesman will call.

Name _____ Age _____

Address _____

City _____ Zone _____ State _____

RADIO - ELECTRONICS

Formerly RADIO CRAFT • Incorporating SHORT WAVE CRAFT • TELEVISION NEWS • RADIO & TELEVISION*

Hugo Gernsback
Editor and Publisher

M. Harvey Gernsback
Editorial Director

Fred Shunaman
Managing Editor

Robert F. Scott
W2PWG, Technical Editor

Jerome Kass
Associate Editor

I. Queen
Editorial Associate

Matthew Mandl
Television Consultant

Charles A. Phelps
Copy Editor

Angie Pascale
Editorial Production

Wm. Lyon McLaughlin
Tech. Illustration Director

Sol Ehrlich
Art Director

Lee Robinson
General Manager

John J. Lamson
Sales Manager

G. Aliquo
Circulation Manager

Adam J. Smith
Director, Newsstand Sales

Robert Fallath
Promotion Manager

Seymour Schwartz
Advertising Production



Member
Magazine Publishers
Association

ON THE COVER (See also
page 82)

Model Mary Gardner puts a
call through from offshore.
Transmitter is on the deck be-
low—the equipment in sight
consists of a receiver and di-
rection finder.

(Color original by Avery Slack)

CONTENTS

SEPTEMBER 1954

Editorial (Page 33)			
Automation	by Hugo Gernsback 33		
Audio-High Fidelity (Pages 34-45)			
Match Your Speakers the Easy Way.....	by Richard H. Houston 34		
Low-Drain Hearing Aid.....	36		
For Golden Ears Only.....	by Monitor 37		
Tape Recorder Servicing.....	by Michael Smollin 40		
Servicing High-Fidelity Equipment, Part VII—Checking the phonograph needle: its condition and alignment.....	by Joseph Marshall 42		
High-Quality Audio, Part XIII—The power amplifier; tubes, single-ended and push-pull stages.....	by Richard H. Dorf 44		
Test Instruments (Pages 46-54)			
New Tools for Audio Technician.....	by Robert F. Scott 46		
Novel Frequency Measuring Method.....	by Sidney Appleby 48		
Pin-Jack Multimeter	by I. Queen 49		
Spot-Checking the Grid-Dip Meter.....	by Harold Reed 51		
Transistor AM Test Oscillator.....	by Edwin Bohr 52		
Television (Pages 55-79)			
Vertical Interlace and Instability.....	by Matthew Mandl 55		
Television—it's a Cinch (Twelfth conversation, second half: More r.f. prob- lems, from the ground up; contrast controls, mixer methods.)	by E. Aisberg 58		
Color TV Circuits, Part IV—Demodulators and matrix circuits	by Ken Kleidon and Phil Steinberg 60		
Tracking Down Horizontal Instability, Part II—Tracing sync pulses: probable point of trouble.....	by Cyrus Glickstein 62		
TV Antenna Repairs.....	by I. J. Sobel 63		
TV Service Clinic.....	Conducted by Jerry Kass 66		
A Superunusual Case.....	by George R. Anglado 74		
Radio (Pages 82-97)			
FCC Boosts Marine Radio (Cover Feature).....	by Elbert Robberson 82		
A More Compact Battery Portable	by I. Queen 90		
Quick Check on 3-Way Portable and Battery Radios.....	by Fairbanks Tryon 94		
ELECTRONICS (Pages 98-112)			
Electronic Photo-Flash System.....	by L. B. Hedge 98		
4-Terminal Transistors	by Nathaniel Rhita 108		
New Design (Page 124)			
New Tubes and Transistors.....	124		
DEPARTMENTS			
The Radio Month.....	6	New Devices	133
Correspondence	16	Radio-Electronic Circuits.....	138
New Patents	116	Question Box	142
Technicians' News	121	Radio Business	144
Technotes	126	People	148
Miscellany	128	Electronic Literature	151
Try This One.....	130	Book Reviews	154



MEMBER Audit Bureau of Circulations

Average Paid Circulation over 171,000

Vol. XXV, No. 9

RADIO-ELECTRONICS, September 1954, Vol. XXV, No. 9. Published monthly at Mt. Morris, Illinois by Gernsback Publications, Inc. Entered as Second Class matter June 23, 1954, at the Post Office at Mt. Morris, Ill. Copyright 1954 by Gernsback Publications, Inc. Text and illustrations must not be reproduced without permission of copyright owners.

EXECUTIVE, EDITORIAL and ADVERTISING OFFICES: Gernsback Publications, Inc., 25 West Broadway, New York 7, N. Y. Telephone REctor 2-8630. Hugo Gernsback, President; M. Harvey Gernsback, Vice-President; G. Aliquo, Secretary.

SUBSCRIPTIONS: Address correspondence to Radio-Electronics, Subscription Dept., 404 N. Wesley Ave., Mt. Morris, Ill., or 25 West Broadway, New York 7, N. Y. When ordering a change please furnish an address stencil impression from a recent wrapper. Allow one month for change of address.

SUBSCRIPTION RATES: In U. S. and Canada, and in U. S. possessions, \$3.50 for one year; \$6.00 for two years; \$8.00 for three years; single copies 35c. All other foreign countries \$4.50 a year; \$8.00 for two years; \$11.00 for three years.

BRANCH ADVERTISING OFFICES: Chicago: 7522 North Sheridan Road, Tel. Rogers Park 4-8000. Los Angeles: Ralph W. Harker and Associates, 1127 Wilshire Blvd., Tel. MADison 6-1271. San Francisco: Ralph W. Harker and Associates, 582 Market St., Tel. GARfield 1-2481. FOREIGN AGENTS: Great Britain: Atlas Publishing and Distributing Co., Ltd., London E.C. 4. Australia: McGill's Agency, Melbourne. France: Brentano's, Paris 2e. Belgium: Agence et Messageries de la Presse, Brussels. Holland: Trillectron, Heemstede. Greece: International Book & News Agency, Athens. So. Africa: Central News Agency Ltd., Johannesburg; Capetown, Durban, Natal. Universal Book Agency, Johannesburg. Middle East: Steimatzky Middle East Agency, Jerusalem. India: Broadway News Centre, Dadar, Bombay #14. Pakistan: Paradise Book Stall, Karachi 3. POSTMASTER: If undeliverable send form 3578 to: RADIO-ELECTRONICS, 25 West Broadway, New York 7, N. Y. *Trademark registered U.S. Patent Office.

ADVANCE! Raise your earning power—learn RADIO-TELEVISION-ELECTRONICS by SHOP-METHOD HOME TRAINING

GOOD JOBS AWAIT THE TRAINED RADIO-TV TECHNICIAN

There is a place for *you* in the great Radio-Television-Electronics industry when you are trained as National Schools will train you at home!

Trained technicians are in growing demand at good pay—in manufacturing, broadcasting, television, communications, radar, research laboratories, home Radio-TV service, and other branches of the field. National Schools Master Shop-Method Home Training, with newly added lessons and equipment, trains you in your spare time, right in your own home, for these fascinating opportunities. **OUR METHOD IS PROVED BY THE SUCCESS OF NATIONAL SCHOOLS TRAINED MEN, ALL OVER THE WORLD, SINCE 1905.**

EARN WHILE YOU LEARN

Many National students pay for all or part of their training with spare time earnings. We'll show you how you can do the same! Early in your training, you receive "Spare-time Work" Lessons which will enable you to earn extra money servicing neighbors' and friends' Radio and Television receivers, appliances, etc.

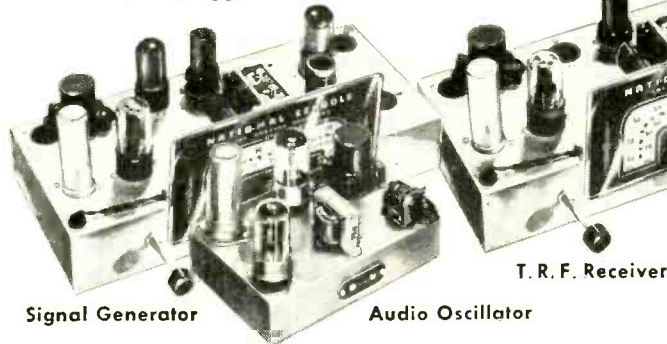

Signal Generator

Audio Oscillator

T. R. F. Receiver

National Schools Training is All-Embracing

National Schools prepares you for your choice of many job opportunities. Thousands of home, portable, and auto radios are being sold daily—more than ever before. Television is sweeping the country, too. Co-axial cables are now bringing Television to more cities, towns, and farms every day! National Schools' *complete* training program qualifies you in all fields. Read this partial list of opportunities for trained technicians:

- Business of Your Own • Broadcasting
- Radio Manufacturing, Sales, Service • Telecasting
- Television Manufacturing, Sales, Service
- Laboratories: Installation, Maintenance of Electronic Equipment
- Electrolysis, Call Systems
- Garages: Auto Radio Sales, Service
- Sound Systems and Telephone Companies, Engineering Firms
- Theatre Sound Systems, Police Radio
- And scores of other good jobs in many related fields.

TELEVISION TRAINING

You get a complete series of up-to-the-minute lessons covering all phases of repairing, servicing and construction. The same lesson texts used by resident students in our modern and complete Television broadcast studios, laboratories and classrooms!



MASTER ALL PHASES!

Get Master Shop-Method Home Training from an Established Practical Resident School with its own Training Shops, Laboratories, Studios—almost 50 Years of Successful Experience in Training Ambitious Men.

We Bring National Schools To You!



Superheterodyne Receiver

You also receive this Multitester

LEARN BY DOING

You receive and keep all the modern equipment shown above, including tubes and valuable, professional quality Multitester. *No extra charges.*

FREE! RADIO-TV BOOK AND SAMPLE LESSON!

Send today for National Schools' new, illustrated Book of Opportunity in Radio-Television-Electronics, and an actual Sample Lesson. No cost—no obligation. Use the coupon now—we'll answer by return airmail.

**APPROVED FOR
VETERANS
AND
NON-VETERANS**
Check coupon below

**Both
Resident and
Home Study
Courses Offered!**



NATIONAL SCHOOLS

LOS ANGELES 37, CALIFORNIA • ESTABLISHED 1905
IN CANADA: 811 W. HASTINGS STREET, VANCOUVER, B.C.

GET FACTS FASTEST! MAIL TO OFFICE NEAREST YOU!

(mail in envelope or paste on postal card)

NATIONAL SCHOOLS, Dept. RG-94

4000 S. Figueroa Street or 323 West Polk Street
Los Angeles 37, Calif. or Chicago 7, Ill.

Send FREE Radio-TV Electronics book and FREE sample lesson. No obligation, no salesman will call.

NAME _____ BIRTHDAY _____ 19 _____

ADDRESS _____

CITY _____ ZONE _____ STATE _____

Check here if interested in Resident School Training at Los Angeles.
VETERANS: Give Date of Discharge

HIGHEST OUTPUT CRYSTAL CARTRIDGE

SIMPLIFIES
Servicing
IMPROVES
Record Playing



THE
HEART
of the
TONE
ARM

*Licensed under
Brush Patents

What a difference in the music you hear...when you install a modern E-V cartridge! Greatly improves reproduction, reduces record wear, extends record and needle life. Check up now! It pays to replace that old-style or inefficient cartridge with a new E-V.

DUO-VOLT MODEL 60. Popular Bimorph* Crystal Cartridge with advanced E-V engineered features. Serves varied replacement needs. Permits selection of high or medium output with 33 $\frac{1}{3}$, 45 and 78 rpm records. No soldering. No accessories to attach or remove. Uses any standard 3-mil, 1-mil, or all-purpose needle. Universal $\frac{1}{2}$ " mounting hole centers. Aluminum case. List, without needle...\$4.95

IMPROVED MODEL 50. High level Bimorph* Crystal Cartridge. Can be used with any standard 3-mil, 1-mil, or all-purpose replacement needle. Output level with straight shank is 3 $\frac{1}{2}$ volts; and with compliant needle is 2 $\frac{1}{2}$ volts. Aluminum case. List, without needle...\$4.50

*© Brush Development Co.

Send for Replacement Guide

Electro-Voice INC.
BUCHANAN · MICHIGAN

THE RADIO MONTH

HOWARD E. ANTHONY owner of the Heath Co. and originator of Heathkits, was killed July 23 in the explosion of a plane in the air near Dayton, Tenn. With Mr. Anthony were the company's pilot, Lawrence Durham, and six other persons. The flight was for the purpose of trying the plane—a De Haviland Dove eight-place executive type—with the idea of acquiring it for the company.

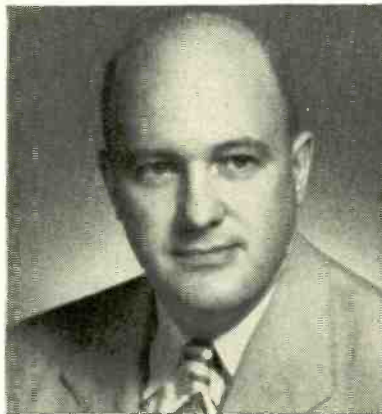

Mr. Anthony was born in Dowagiac, Mich., and received his education at Hillsdale College, Hillsdale, Mich. He bought the Heath Co. (then an aircraft firm) in 1935, continuing the manufacture of aircraft accessories till 1946, when he turned the activities of the company over completely to electronics. At the time of his death Mr. Anthony was a member of the Airport Board and of the boards of the Farmers' and Merchants' Bank and of Mercy Hospital, all of Benton Harbor, and a trustee of Hillsdale College.

His wife, Helen C. Anthony, his mother, and two sisters survive him.

19-INCH COLOR TV receiver sells for \$895. Using the CBS color tube, Motorola claims it is the first receiver with this size tube on the market for less than \$1,000.

The receiver cabinet is about the size of present 24-inch monochrome sets and has only 29 tubes.

BIGGEST RADIO TELESCOPE in the world is searching the sky for new radio "stars." The new radio telescope is not a parabola, but consists of dipole antennas strung in a straight line for 2,000 feet.

Two poles 25 feet apart and 15 feet high, linked together by taut wire, form each dipole. All the dipoles are connected to the recording point by a coaxial cable.

The telescope, built by the Carnegie Institution of Washington, will survey radio noise received on earth from space in the 20-mc range.

SMALLEST TV STATION in the world has been unveiled at the U.S. Air Force Base in Limestone, Maine. The miniature station (see photo) broadcasts with a power of 8 watts and has a coverage of 3 miles in radius. The television studio and equipment, installed by RCA, is housed in a 10 by 13-foot area atop the four-story base hospital.

The station has been on the air approximately 6 months on an experimental basis, and broadcasts kinescope recordings of top network programs from major broadcasting systems.

A similar station, government operated, has begun operation near White Sands Proving Ground, New Mexico, to provide TV service to the 3,000 military and civilian personnel at the installation.



Photo Radio Corporation of America
Staff Sergeant James R. Dean mans the controls of the little TV station

Now.. In Your Own Home **LEARN**

TELEVISION

RADIO-ELECTRONICS

THE AMAZINGLY EFFECTIVE

D.T.I. WAY

—with the aid of BOTH HOME LAB EQUIPMENT and HOME MOVIES

NO PREVIOUS TECHNICAL EXPERIENCE NEEDED

NOW... get EVERYTHING YOU NEED

for real Laboratory-type training **AT HOME**

5 INCH "SCOPE"

Oscilloscope

Multi-Meter

21 INCH

Build and keep this BIG DTI Engineered TV set—easily converted to U.H.F. (DTI offers another home training, but without the TV set.)

Above: Work over 300 interesting experiments with this equipment

"ONE OF AMERICA'S FOREMOST TELEVISION TRAINING CENTERS"

Home Movies

Get this information-packed publication **FREE!**

89 WAYS TO EARN MONEY IN TELEVISION RADIO ELECTRONICS

MODERN LABORATORIES

If you prefer, get all your preparation in our new Chicago Training Laboratories—one of the finest of its kind. Ample instructors, modern equipment. Write for details!

MILITARY SERVICE!

If you're subject to military service, the information we have for you should prove very helpful. Mail coupon today.

What will mailing the coupon below do for YOU? Just this! You'll find out about one of today's most remarkable... practical ways to prepare to get into America's amazing billion dollar opportunity field of TELEVISION-RADIO-ELECTRONICS. You'll see how to get into highly interesting work that pays well... that offers one of America's most promising futures... that enables you to start your own business almost "on a shoe string," if you prefer this to a job opportunity.

And above all, you'll get some GOOD NEWS especially welcomed by men anxious to earn REAL MONEY in this growing field. For you'll see that NOW you can get the kind of practical, laboratory-type training so desirable for making real progress in Television-Radio-Electronics AND WITHOUT LEAVING HOME.

You'll see that DeVRY Technical Institute sends everything needed to set up your own HOME LABORATORY. You get and keep the same type of basic electronic equipment used in our modern Chicago Training Laboratories. You get home training that includes the knowledge and experience gained from training thousands of students first hand in Chicago. And to top it all, you use DTI's amazingly effective and exclusive home training aid—INSTRUCTIVE MOVIES. But why not get the complete story? Mail coupon today for complete facts

1. Build over 300 fascinating experiments from 16 BIG SHIPMENTS of Electronic-Radio parts which you KEEP.
2. Build valuable commercial-type test equipment—as shown to the left—which you KEEP. This includes a quality 5 INCH oscilloscope and jewel bearing Multi-Meter—both highly useful for Television work.
3. Build and keep a big 21 INCH TV Set. (D.T.I. offers another home training in Television-Radio-Electronics, but without the TV set.)

4. Use a 16 mm. movie projector and a new series of highly instructive movies—a wonderful aid to help you grasp important fundamentals faster... easier... better.
5. Enjoy well-illustrated, easy-to-read diagrams. Lessons with handy FOLD-OUT diagrams.
6. Get an honest-to-goodness EMPLOYMENT SERVICE to help you get a good job after graduating—or assistance in starting your OWN SALES AND SERVICE BUSINESS. Mail coupon today for the complete details.

DEVRY TECHNICAL INSTITUTE

4141 BELMONT AVE., CHICAGO 41, ILL. Dept. RE-9-K

I would like your valuable information-packed publication showing how I can get started toward a good job or my own business in Television-Radio-Electronics.

Name _____ Age _____
 Street _____ Apt. _____
 City _____ Zone _____ State _____

D.T.I.'s Training is available in Canada

DEVRY TECHNICAL INSTITUTE

AFFILIATED WITH
DEFOREST'S TRAINING, INC.
 CHICAGO 41, ILLINOIS

Quality Features OF **TUNG-SOL** PICTURE TUBES

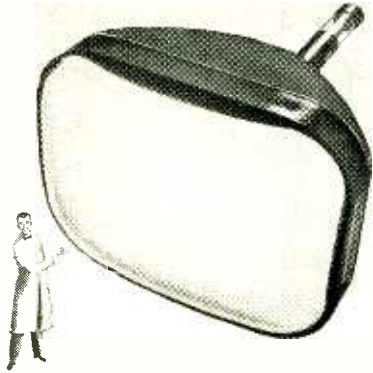

Gun made of best grade non-magnetic steel.

Glass bead type assembly is stronger both mechanically and electrically—gives greater protection against electrical leakage.

Rolled edges in gun minimize corona.

Custom built stem with greater spacing between leads assures minimum leakage.

Low resistance of outside conductive coating minimizes radiation of horizontal oscillator sweep frequency.

Double cathode tab provides double protection against cathode circuit failure.

Selected screen composition resists burning (X pattern).

Rigid control of internal conductive coating provides utmost service reliability.

Designed for use with single or double field ion trap designs.

One-piece construction of parts assures better alignment.

Maximum dispersion of screen coating assures uniform screen distribution.

Tung-Sol makes All-Glass Sealed Beam Lamps, Miniature Lamps, Signal Flashers, Picture Tubes, Radio, TV and Special Purpose Electron Tubes and Semiconductor Products.

TUNG-SOL ELECTRIC INC., Newark 4, N. J. Sales Offices: Atlanta, Chicago, Columbus, Culver City (Los Angeles), Dallas, Denver, Detroit, Newark, Seattle.

TUNG-SOL RADIO AND TV TUBES



You Can Build A Reputation On Tung-Sol Quality

THE RADIO MONTH

SERIES-STRING TUBES especially designed for TV have been announced by RCA. The new tubes, the 3BC5, 3CB6, 5AN8, 5AT8, 5J6, 5U8, and 12L6-GT, have 600-milliamper heaters. They are designed for receivers using series-connected heaters, including the heater of the picture tube. These new tubes have heaters designed for the same warmup time to minimize voltage unbalance during starting.

RCA recommends that a high-wattage resistor, preferably with a positive temperature characteristic, be used in series with the string of tubes to minimize voltage unbalance across any individual tube during starting.

TINY TRANSMITTER for TV performers demonstrated by the National Broadcasting Co. weighs only 8 ounces. The unit, consisting of a microphone, transmitter, and antenna, can be concealed on a performer, giving him complete freedom of movement, otherwise limited by conventional fixed or boom-mounted microphones.

The small size of the unit is primarily due to transistor circuitry. Since the transmitter—working on the inductive principle—radiates almost no power, the Federal Communications Commission does not require licensing.

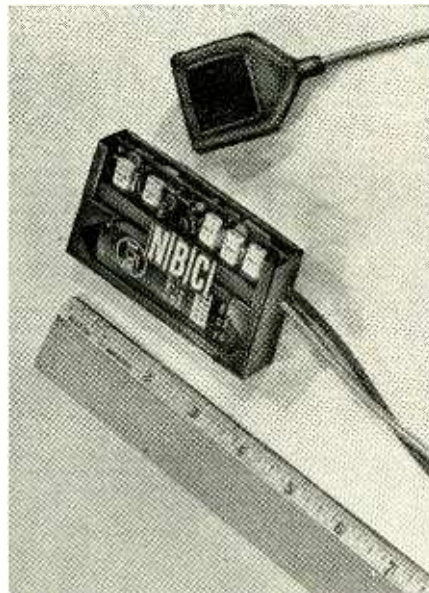

The transistor transmitter. The two "leads" are part of the inductive transmitting loop, which consists of a number of strands of fine wire. The performer can wear it as a belt.

DR. DAVID GALEN McCAA, a pioneer in the early development of radio and an associate of Marconi, died June 23 at the age of 72.

While doing research with X-rays in 1906, McCaa discovered that the human voice could be transmitted over an electric arc. In 1914 he sailed from New York City to Norfolk, Va., transmitting to a receiver located in N.Y. in an experiment to determine how far wireless sound could be sent.

In the '20's he was prominent in the development of anti-static devices.

NEW TECHNIQUES in shortwave communication—including miniature receivers with skin-conduction transducers instead of earphones—were used by a group of gamblers operating from Jamaica Racetrack, near New York City, and possibly other points. Twenty-eight supposed members of the gang were arrested by the police, including a radio service technician and electronics expert of the Cortlandt St. area, who was said to have designed the equipment for the ring.

Using pocket transmitters, gamblers at the track radioed the numbers of winning horses the instant they crossed the finish line. The information, picked up on a sensitive receiver by a ring-leader less than a half mile from the track, was phoned to confederates in various parts of the country, long before the official returns could be received.

Information received from New York was in some cases used by gamblers to transmit information to partners in nearby "horse parlors." Suitcase transmitters—more powerful than the pocket ones—were used. The gambler in the betting parlor, wearing an inconspicuous receiver which used two dimes held against the wrist by adhesive instead of an earphone, could receive the results of a race while in full view of the bookmaker, who would be sure he had no means of obtaining advance information.

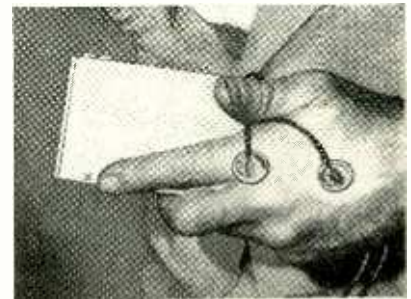

Radio has skin-shock wrist electrodes.

NINE NEW TV STATIONS have gone on the air since our last report. These are:

WMSL-TV	Decatur, Ala.	23
WISH-TV	Indianapolis, Ind.	8
KDRO-TV	Sedalia, Mo.	6
KWK	St. Louis, Mo.	4
KGVO-TV	Missoula, Mont.	13
WCET	Cincinnati, O.	48
KGEO-TV	Enid, Okla.	5
WLAC-TV	Nashville, Tenn.	5
WKBT	La Crosse, Wis.	8
Nine stations have gone off the air:		

KOY-TV	Phoenix, Ariz.	10
WRAY-TV	Princeton, Ind.	52
WFTV	Duluth, Minn.	38
KMBC-TV	Kansas City, Mo.	9
KCTY	Kansas City, Mo.	25
WECT	Elmira, N.Y.	18
WKJF-TV	Pittsburgh, Pa.	53
KNUZ-TV	Houston, Tex.	39
WROV-TV	Roanoke, Va.	27

One Mexican station went off the air this month, XELD-TV, Matamoros, channel 7. END

Now, TV set owners can understand benefits of Aluminized Tubes!



These three advertisements will appear in **POST** this fall.

THESE ADVERTISEMENTS IN **POST** EXPLAIN THAT:

1. **IN MAGAZINES**, the pictures you see (when magnified) are made by a series of tiny dots applied to the paper *mechanically*.

ON YOUR TV SCREEN, the pictures are also made by a series of dots (which appear as lines) applied *electronically*. These dots, in both cases, create a *variety* of tones including black, a range of grays, and white. **BUT**, it is the **LENGTH** of this "Black-to-White Range" (the gray scale) that makes the picture excellent, good, fair, or poor.

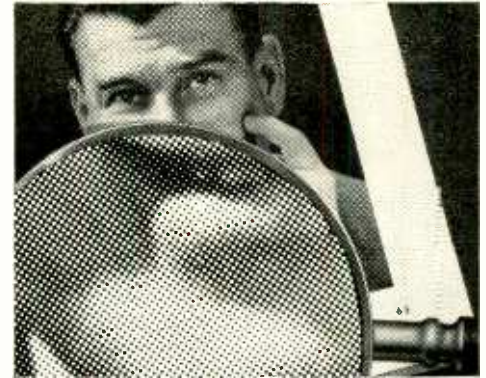

ARTHUR GODFREY famous CBS star



TRUE BLACK

SHORT
"BLACK-TO-WHITE RANGE"

TRUE WHITE



LONG
"BLACK-TO-WHITE RANGE"

2. **ORDINARY PICTURE TUBES** used in most TV sets made before 1953 produce a *short* "Black-to-White Range." While the picture is good, the picture tube cannot develop enough *light output* for a long "Black-to-White Range."

3. **CBS-HYTRON MIRROR-BACK TUBES** produce up to *twice the light output* of ordinary picture tubes. Like the silver backing on a mirror, the *shiny* aluminum backing on a Mirror-Back tube reflects to the viewer *all the light* on the screen. The resulting increased brightness and reduced halation (unwanted spreading of light from one dot to another) is *essential* to give you a *long* "Black-to-White Range." The full range you *must* have for the clearest, sharpest, brightest pictures that are a joy to watch.

TALK LONG "BLACK-TO-WHITE RANGE" PICTURES ...SELL BIGGER-PROFIT

CBS-HYTRON MIRROR-BACK PICTURE TUBES

Talk . . . demonstrate . . . and sell "Long-Black-to-White-Range" clearer, sharper, brighter pictures. It's easier to sell premium-grade, brand-new CBS-Hytron Mirror-Backs . . . with their controlled quality and dependable full-year guarantee. Profit more. Tie in with POST. Get this Mirror-Back Promotion Kit . . . from your CBS-Hytron distributor, or mail coupon,



CBS-HYTRON, Danvers, Mass.

I want all the material to identify me as a *Certified* Quality Service dealer who sells Mirror-Back tubes. Please rush me CBS-Hytron Mirror-Back Promotion Kit containing:

1. 22 x 28-inch Advertised-in-POST window poster.
 2. 25 consumer self-mailers, "How You Can Have Clearer, Sharper, Brighter TV Pictures."
 3. *Certified* Quality Service decalcomania.
- I enclose 25¢ for postage and handling.
I want . . . more consumer self-mailers at 1¢ each, for which I enclose an additional \$

Name (please print)

Street

City State



CBS-HYTRON Main Office: Danvers, Massachusetts

A Division of Columbia Broadcasting System, Inc.

A member of the CBS family: CBS Radio
CBS Television • Columbia Records, Inc.

CBS Laboratories • CBS-Columbia • CBS International • and CBS-Hytron

after
you
leave . . .

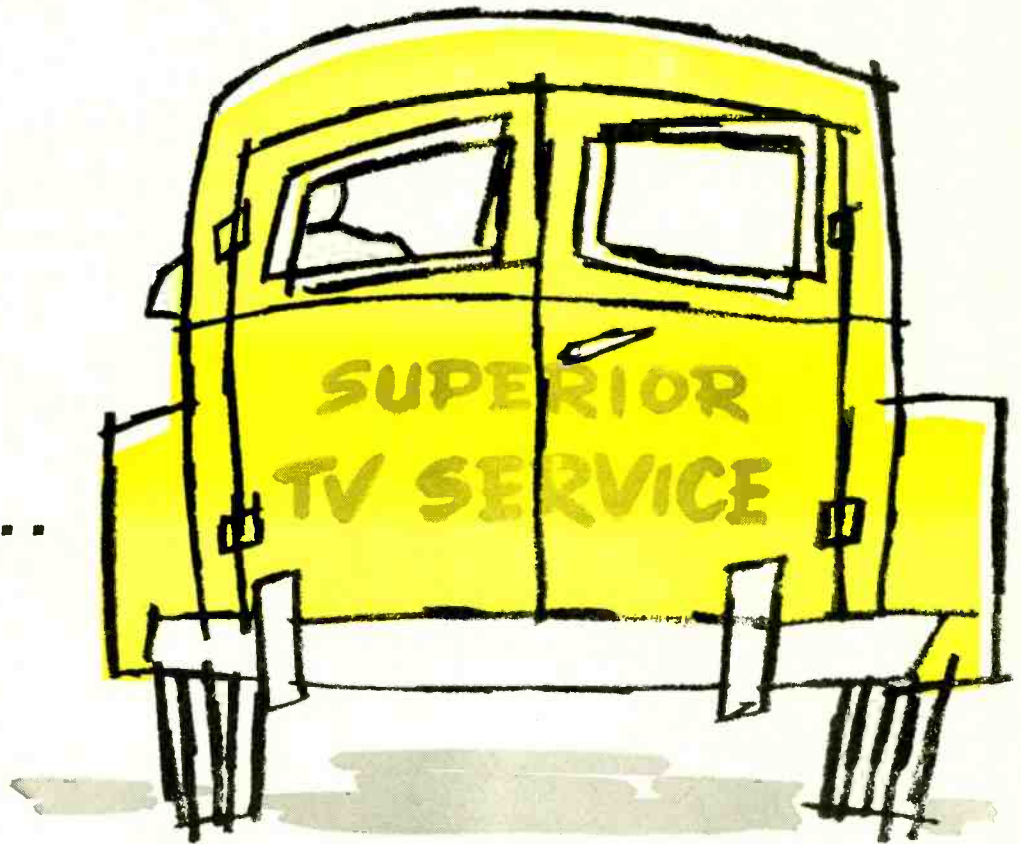

ASTRON

capacitors

build your reputation

Consumer satisfaction means repeat business. That's why smart servicemen install **ASTRON BLUE POINT®** capacitors and **SAFETY MARGIN*** electrolytics.

They know **ASTRON** capacitors are worthy of their trust.

Exclusive **ASTRON**-developed material treatments, electrolytes, tough element-proof shells and contamination free assembly . . . stop call-backs, insure consumer satisfaction.

Servicemen install **ASTRON** capacitors because they know that more and more TV & Radio manufacturers use them in original equipment.

More and more manufacturers are using them because of their surprisingly long life and utmost dependability!

Try something new . . . start installing **ASTRON CAPACITORS** today . . . they work for you long after you leave the call.

*TRADEMARK

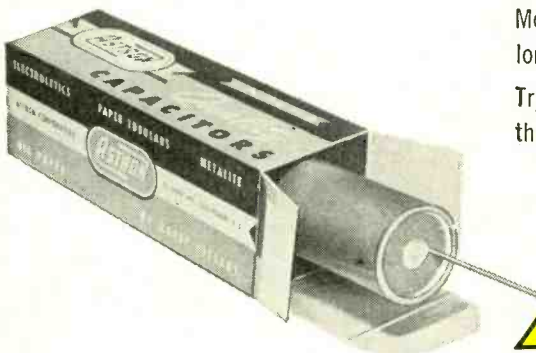

ASTRON
CORPORATION

255 GRANT AVENUE, E. NEWARK, N. J.



Export Division: Roche International Corp., 13 E. 40 St., New York, N. Y.
In Canada: Charles W. Pointon, 6 Alcina Ave., Toronto 10, Ontario

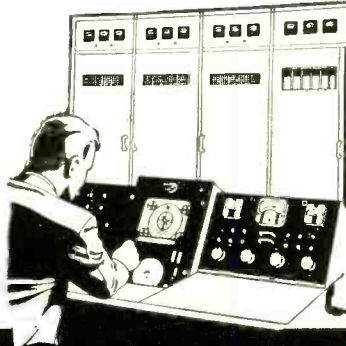

Where Will You Be
in **ELECTRONICS**
6 Months from Today?



ADD TECHNICAL TRAINING to your practical experience

Get Your FCC License In A Hurry!

Then Use Our Amazingly Effective
JOB FINDING SERVICE

Get This Valuable Booklet **FREE**



TELLS HOW—

HERE IS YOUR GUARANTEE

If you fail to pass your Commercial License exam after completing our course, we guarantee to continue your training without additional cost of any kind, until you successfully obtain your Commercial license, provided you first sit for this examination within 90 days after completing our course.

WE GUARANTEE

TO TRAIN AND COACH YOU AT HOME IN SPARE TIME UNTIL YOU GET

YOUR FCC LICENSE

If you have had any practical experience—Amateur, Army, Navy, Radio repair, or experimenting.

TV ENGINEERING INCLUDED IN OUR TRAINING & COACHING

TELLS HOW—

Our Amazingly Effective **JOB-FINDING SERVICE**

Helps CIRE Students Get Better Jobs

Here are a few recent examples of Job-Finding Results!

GETS AIRLINES JOB

"Due to your Job-Finding Service, I have been getting many offers from all over the country, and I have taken a job with Capital Airlines in Chicago, as a Radio Mechanic."
Harry Clare, 4537 S. Drexel Blvd., Chicago, Ill.

GETS FIVE JOB-OFFERS FROM BRDADCAST STATIONS

"Your 'Chief Engineer's Bulletin' is a grand way of obtaining employment for your graduates who have obtained their 1st class license. Since my name has been on the list I have received calls or letters from five stations in the southern states, and am now employed as Transmitter Engineer at WMMT."
Elmer Powell, Box 274, Sparta, Tenn.

GETS CIVIL SERVICE JOB

"I have obtained a position at Wright-Patterson Air Force Base, Dayton, Ohio, as Junior Electronic Equipment Repairman. The Employment Application you prepared for me had a lot to do with me landing this desirable position."
Charles E. Loomis, 4516 Genesee Ave., Dayton, Ohio.

Your FCC ticket is recognized by employers in the electronic field as proof of your technical ability.

TELLS HOW—Employers make JOB OFFERS Like These

to Our Graduates Every Month

Letter from nationally-known Airlines, "We would also appreciate if you would place the following additional advertisement in your bulletin—Wanted—Superintendent of Communications . . . Salary \$666.66 per month."

Letter from nationally known manufacturer of high quality AM and FM transmitters, "We are very much in need at the present time of radio-electronics technicians and would appreciate any helpful suggestions that you may be able to offer. Salary up to \$412 per month to start."

These are just a few examples of the job offers that come to our office periodically. Some licensed radioman filled each of these jobs . . . it might have been you!

HERE'S PROOF FCC LICENSES ARE OFTEN SECURED IN A FEW HOURS OF STUDY WITH OUR COACHING AT HOME in Spare Time.

Name and Address	License	Lessons
Lee Worthy 2210 1/2 Wilshire St., Bakersfield, Calif.	2nd Phone	16
Clifford E. Voot, Box 1016, Dania, Fla.	1st Phone	20
Francis X. Foersch, 38 Beucelar Pl., Bergenfield, N. J.	1st Phone	38
S/Sgt. Ben H. Davis, 317 North Roosevelt, Lebanon, Ill.	1st Phone	28
Albert Schoell, 110 West 11th St., Escondido, Calif.	2nd Phone	23

CLEVELAND INSTITUTE OF RADIO ELECTRONICS
CARL E. SMITH, E.E., Consulting Engineer, President
Desk RE-68, 4900 Euclid Bldg., Cleveland 3, Ohio

OURS IS THE ONLY HOME STUDY COURSE WHICH SUPPLIES FCC-TYPE EXAMINATIONS WITH ALL LESSONS AND FINAL TESTS.



GET ALL 3 FREE! MAIL COUPON NOW

CLEVELAND INSTITUTE OF RADIO ELECTRONICS
Desk RE-68, 4900 Euclid Bldg., Cleveland 3, Ohio
(Address to Desk No. to avoid delay)

I want to know how I can get my FCC ticket in a minimum of time. Send me your FREE booklet, "How to Pass FCC License Examinations" (does not cover exams for Amateur License), as well as a sample FCC-type exam and the amazing new booklet, "Money-Making FCC License Information."

Be sure to tell me about your television engineering course.

Name.....
Address.....
City.....Zone.....State.....

Special tuition rates to members of the U.S. Armed Forces. Paste on 2-cent postcard or send air mail.

Mr. Service Dealer:

THIS **RAYTHEON** AD IS YOUR AD

LIFE

DOCTOR
(of Sound and Sight)

Your **RADIO AND TELEVISION SERVICE DEALERS** might be called *eye and ear specialists*, because theirs is the exacting job of curing the ills of the instruments that supply you with looking and listening pleasure. To accomplish the tremendous task of keeping America's millions upon millions of television and radio sets in top condition, requires many trained technicians, expensive up-to-the-minute equipment, and a wealth of experience and know-how.

America is fortunate indeed to have tens-of-thousands of competent TV-Radio technicians from coast to coast, doing the miraculous job of keeping up with this complex and fast growing industry. Raytheon salutes them all and is especially proud of those who are **RAYTHEON BONDED ELECTRONIC TECHNICIANS**. During the past ten years more than 35,000 Registered Bond Certificates have been issued by Raytheon to qualified service dealers all over the country. In spite of the fact that these dealers have handled many millions of jobs *less than fifty complaints* have been received.

Facts such as these justify confidence in your TV and Radio Service Dealer. Make doubly sure of satisfaction by taking a moment to look up the *Raytheon Bonded Electronic Technician* near you. Find him through his shop identification or in the yellow pages of your telephone directory.

RAYTHEON
NEWTON • CHICAGO • ATLANTA • LOS ANGELES

RAYTHEON
BONDED
ELECTRONIC TECHNICIAN

CCC

Look for this seal, Let's what it stands for:

1. GUARANTEES ALL RADIO AND TELEVISION SETS UP TO 90 DAYS
2. USE ONLY PARTS OF RECOGNIZED QUALITY
3. CHARGES NOT MORE THAN LIST PRICE FOR PARTS
4. TEST CUSTOMERS' TUBES AS ACCURATELY AS POSSIBLE
5. KEEP LABOR CHARGES AT A REASONABLE LEVEL
6. PERFORM ONLY SUCH WORK AS IS NECESSARY
7. MAINTAIN PROPER EQUIPMENT FOR GOOD WORK
8. MAINTAIN THE HIGHEST QUALITY SERVICE

SEPT. 13, 1954

More than twenty-six million people will read about you and the good work *you* are doing, in the September 13th issue of LIFE Magazine. We at Raytheon are publishing this advertisement because we believe you deserve a public pat on the back for the successful way you have met every challenge of the Radio and Television Service industry. We

are telling you about it in advance so that you can take full advantage of its appearance to help increase your volume and profit. It's our way of saying thank you for using and recommending *Raytheon Quality Radio and Television Tubes*.



RAYTHEON MANUFACTURING COMPANY

Receiving and Cathode Ray Tube Operations
Newton, Mass., Chicago, Ill., Atlanta, Ga., Los Angeles, Calif.

Excellence in Electronics

RAYTHEON MAKES ALL THESE:

RECEIVING AND PICTURE TUBES • RELIABLE SUBMINIATURE AND MINIATURE TUBES • SEMICONDUCTOR DIODES AND TRANSISTORS • NUCLEONIC TUBES • MICROWAVE TUBES

Here comes opportunity ...ready or not!

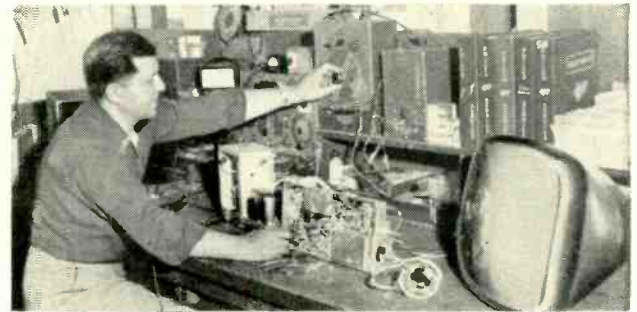
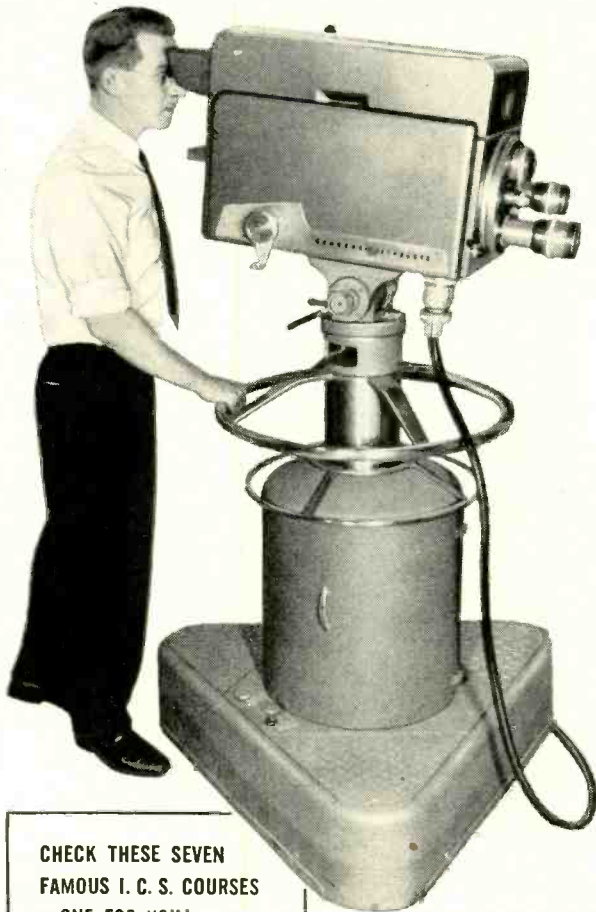

- Prepare now for the new Radio-TV-Electronics boom. Get in on VHF and UHF . . . aviation and mobile radio . . . color TV . . . binaural sound! The International Correspondence Schools can help you!

If you've ever thought about Radio or Television as a career . . . if you have the interest, but not the training . . . if you're waiting for a good time to start . . . NOW'S THE TIME!

No matter what your previous background, I.C.S. can help you. If Radio-TV servicing is your hobby, I.C.S. can make it your own profitable business. If you're interested in the new developments in Electronics, I.C.S. can give you the basic courses of training you need. If you have the job but want faster progress, I.C.S. can qualify you for promotions and pay raises.

I.C.S. training is *success-proved* training. Hundreds of I.C.S. graduates hold top jobs with top firms like R.C.A., G.E., DUMONT, I.T.&T. Hundreds of others have high ratings in military and civil service. Still others have successful businesses of their own.

With I.C.S., you get the rock-bottom basics and theory as well as the all-important bench practice and experimentation. You learn in your spare time—no interference with business or social life. You set your own pace—progress as rapidly as you wish.

Free career guidance: Send today for the two free success books, the 36-page "How to Succeed" and the informative catalog on the course you check below. No obligation. Just mark and mail the coupon. With so much at stake, you owe it to yourself to act—and act fast!

CHECK THESE SEVEN
FAMOUS I. C. S. COURSES
—ONE FOR YOU!

..... *For Real Job Security—Get I.C.S. Training!

I.C.S., Scranton 9, Penna.

- PRACTICAL RADIO-TELEVISION ENGINEERING**—Foundation course for radio-television career. Basic principles plus advanced training. Radio, Sound, TV.
- TELEVISION TECHNICIAN**—To qualify you for high-level technical positions in television. Camera, studio, transmitter techniques. Manufacture, sale and installation of TV equipment.
- TELEVISION RECEIVER SERVICING**—Installation, servicing, conversion. Dealership. For the man who knows about radio and wants TV training.
- RADIO & TELEVISION SERVICING**—Designed to start you repairing, installing and servicing radio and television receivers soon after starting the course.
- RADIO & TELEVISION SERVICING WITH TRAINING EQUIPMENT**—Same as above but with addition of high-grade radio servicing equipment and tools.
- RADIO OPERATING COURSE**—Special course to help you pass the Government examination for operator's licenses. Code TV, FM. Radio regulations.
- INDUSTRIAL ELECTRONICS**—Broad, solid background course devoted to the electron tube and to its many applications.

INTERNATIONAL CORRESPONDENCE SCHOOLS

2879-L, SCRANTON 9, PENNA.

Without cost or obligation, send me "HOW to SUCCEED" and the booklet about the course BEFORE which I have marked X:

- | | | | | |
|--|---|---|---|--|
| <p>ART</p> <ul style="list-style-type: none"> <input type="checkbox"/> Commercial Art <input type="checkbox"/> Magazine Illustrating <input type="checkbox"/> Fashion Illustrating <input type="checkbox"/> Cartooning <input type="checkbox"/> Sketching and Painting <input type="checkbox"/> Show Card and Sign Lettering <p>AUTOMOTIVE</p> <ul style="list-style-type: none"> <input type="checkbox"/> Automobile, Mechanic <input type="checkbox"/> Auto Elec. Technician <input type="checkbox"/> Auto Body Rebuilding and Refinishing <input type="checkbox"/> Diesel—Gas Engines <p>AVIATION</p> <ul style="list-style-type: none"> <input type="checkbox"/> Aeronautical Engineering Jr. <input type="checkbox"/> Aircraft Engine Mechanic <input type="checkbox"/> Airplane Drafting <p>BUILDING</p> <ul style="list-style-type: none"> <input type="checkbox"/> Architecture <input type="checkbox"/> Arch. Drafting <input type="checkbox"/> Building Contractor <input type="checkbox"/> Estimating <input type="checkbox"/> Carpenter and Mill Work <input type="checkbox"/> Carpenter Foreman <input type="checkbox"/> Reading Blueprints <input type="checkbox"/> House Planning <input type="checkbox"/> Plumbing | <ul style="list-style-type: none"> <input type="checkbox"/> Heating <input type="checkbox"/> Painting Contractor <input type="checkbox"/> Air Conditioning <input type="checkbox"/> Electrician <p>BUSINESS</p> <ul style="list-style-type: none"> <input type="checkbox"/> Business Administration <input type="checkbox"/> Certified Public Accountant <input type="checkbox"/> Bookkeeping and Accounting <input type="checkbox"/> Office Management <input type="checkbox"/> Stenography and Typing <input type="checkbox"/> Secretarial <input type="checkbox"/> Federal Tax <input type="checkbox"/> Business Correspondence <input type="checkbox"/> Letter-writing Improvement <input type="checkbox"/> Personnel and Labor Relations <input type="checkbox"/> Advertising <input type="checkbox"/> Retail Business Management <input type="checkbox"/> Managing Small Business <input type="checkbox"/> Ocean Navigation <input type="checkbox"/> Sales Management <input type="checkbox"/> Short Story Writing <input type="checkbox"/> Creative Salesmanship <input type="checkbox"/> Traffic Management <p>CHEMISTRY</p> <ul style="list-style-type: none"> <input type="checkbox"/> Chemical Engineering <input type="checkbox"/> Chemistry <input type="checkbox"/> Analytical Chemistry | <ul style="list-style-type: none"> <input type="checkbox"/> Petroleum—Nat'l Gas <input type="checkbox"/> Pulp and Paper Making <input type="checkbox"/> Plastics <p>CIVIL, STRUCTURAL ENGINEERING</p> <ul style="list-style-type: none"> <input type="checkbox"/> Civil Engineering <input type="checkbox"/> Structural Engineering <input type="checkbox"/> Surveying and Mapping <input type="checkbox"/> Structural Drafting <input type="checkbox"/> Highway Engineering <input type="checkbox"/> Reading Blueprints <input type="checkbox"/> Construction Engineering <input type="checkbox"/> Sanitary Engineering <p>DRAFTING</p> <ul style="list-style-type: none"> <input type="checkbox"/> Aircraft Drafting <input type="checkbox"/> Architectural Drafting <input type="checkbox"/> Electrical Drafting <input type="checkbox"/> Mechanical Drafting <input type="checkbox"/> Structural Drafting <input type="checkbox"/> Sheet Metal Drafting <input type="checkbox"/> Ship Drafting <input type="checkbox"/> Mine Surveying and Drafting <p>ELECTRICAL</p> <ul style="list-style-type: none"> <input type="checkbox"/> Electrical Engineering <input type="checkbox"/> Electrical <input type="checkbox"/> Electrical Maintenance | <ul style="list-style-type: none"> <input type="checkbox"/> Electrical Drafting <input type="checkbox"/> Electric Power and Light <input type="checkbox"/> Lineman <p>HIGH SCHOOL</p> <ul style="list-style-type: none"> <input type="checkbox"/> High School Subjects <input type="checkbox"/> Mathematics <input type="checkbox"/> Commercial <input type="checkbox"/> Good English <p>MECHANICAL AND SHOP</p> <ul style="list-style-type: none"> <input type="checkbox"/> Mechanical Engineering <input type="checkbox"/> Industrial Engineering <input type="checkbox"/> Industrial Supervision <input type="checkbox"/> Foremanship <input type="checkbox"/> Mechanical Drafting <input type="checkbox"/> Machine Design-Drafting <input type="checkbox"/> Machine Shop Practice <input type="checkbox"/> Tool Design <input type="checkbox"/> Industrial Instrumentation <input type="checkbox"/> Machine Shop Inspection <input type="checkbox"/> Reading Blueprints <input type="checkbox"/> Toolmaking <input type="checkbox"/> Gas—Electric Welding <input type="checkbox"/> Heat Treatment—Metallurgy <input type="checkbox"/> Sheet Metal Work <input type="checkbox"/> Sheet Metal Pattern Drafting <input type="checkbox"/> Refrigeration | <p>POWER</p> <ul style="list-style-type: none"> <input type="checkbox"/> Combustion Engineering <input type="checkbox"/> Diesel—Electric <input type="checkbox"/> Electric Light and Power <input type="checkbox"/> Stationary Steam Engineering <input type="checkbox"/> Stationary Fireman <p>RADIO, TELEVISION COMMUNICATIONS</p> <ul style="list-style-type: none"> <input type="checkbox"/> Practical Radio—TV Eng'ring <input type="checkbox"/> Radio Operating <input type="checkbox"/> Radio and TV Servicing <input type="checkbox"/> Television—Technician <input type="checkbox"/> Electronics <input type="checkbox"/> Telephone Work <p>RAILROAD</p> <ul style="list-style-type: none"> <input type="checkbox"/> Locomotive Engineer <input type="checkbox"/> Diesel Locomotive <input type="checkbox"/> Air Brakes <input type="checkbox"/> Car Inspector <input type="checkbox"/> Railroad Administration <p>TEXTILE</p> <ul style="list-style-type: none"> <input type="checkbox"/> Textile Engineering <input type="checkbox"/> Cotton, Rayon, Woolen Mfg. <input type="checkbox"/> Carding and Spinning <input type="checkbox"/> Warping and Weaving <input type="checkbox"/> Loom Fixing <input type="checkbox"/> Throwing <input type="checkbox"/> Finishing and Dyeing <input type="checkbox"/> Textile Designing |
|--|---|---|---|--|

Name _____ Age _____ Home Address _____

City _____ Zone _____ State _____ Working Hours _____ A.M. to P.M. _____

Occupation _____ Canadian residents send coupon to International Correspondence Schools Canadian, Ltd., Montreal, Canada. . . . Special tuition rates to members of the U. S. Armed Forces.

It's New! It's Here!



PP SILVER

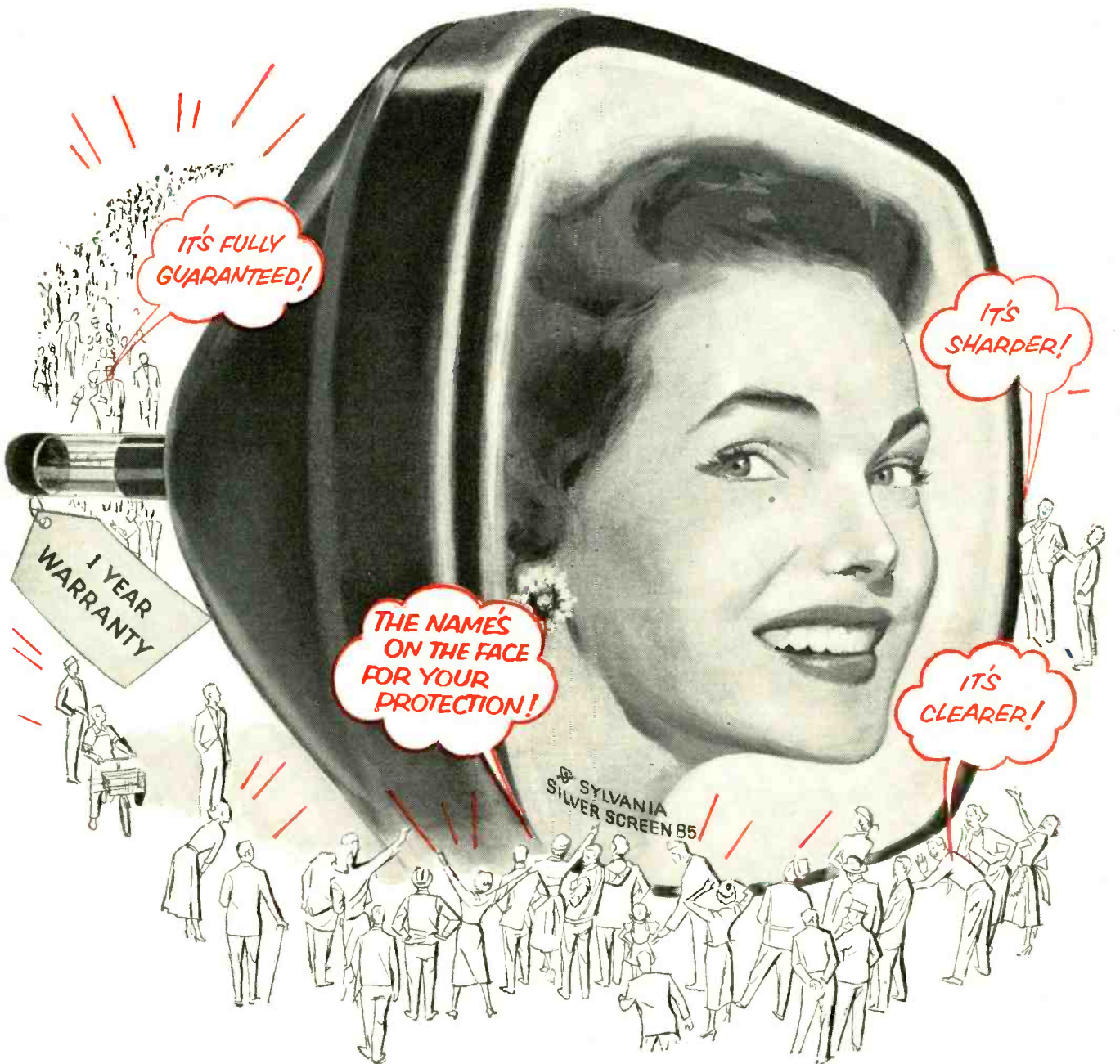

*IT'S FULLY
GUARANTEED!*

*IT'S
SHARPER!*

*THE NAME'S
ON THE FACE
FOR YOUR
PROTECTION!*

*IT'S
CLEARER!*

**1 YEAR
WARRANTY**

SYLVANIA
SILVER SCREEN 85

IT'S SYLVANIA'S

SCREEN 85⁹⁹

The Picture Tube with three amazing design features!

**SILVER-ACTIVATED SCREEN...SUPER ALUMINIZED REFLECTOR
PRECISION-FOCUS ELECTRON GUN**

**YOU CAN BE PART OF THE
BIGGEST PICTURE TUBE
CAMPAIGN IN THE INDUSTRY!**

All this promotion material
is yours **FREE**
—All you have to do is ask for it!

- attractive window streamers . . .
- colorful counter and window displays . . .
- radio and TV commercials for you to use on your local stations . . .
- newspaper mats . . .
- publicity releases . . .
- postcards . . .
- envelope stuffers . . .
- a brand new booklet to describe the revolutionary "Silver Screen 85" to your customers . . .



Here is a truly great achievement in television picture tubes! Sylvania's "SILVER SCREEN 85" is the last word in design and engineering perfection. It's the picture tube with the SILVER-ACTIVATED SCREEN, to produce television's sharpest, clearest pictures; the SUPER ALUMINIZED REFLECTOR to catch and use all available light, giving pictures more depth, more dimension than ever before; the PRECISION-FOCUS ELECTRON GUN that scans every inch of the screen, making images stand out in pinpoint detail.

From foreground to background, pictures are razor-sharp, crystal clear! Blacks are really black—whites are true white. Only professional movies can duplicate

the "Silver Screen 85" picture. It's a SUPER ALUMINIZED PICTURE TUBE, designed to give top performance, made to the highest quality standards, and backed by the world's most experienced manufacturer of picture tubes!



24 MILLION PEOPLE—INCLUDING YOUR CUSTOMERS—WILL HEAR ABOUT THE "SILVER SCREEN 85" EVERY WEEK ON "BEAT THE CLOCK"! 80 STATIONS NOW REACH 93% OF THE TV HOMES IN THE COUNTRY.

Right in your own town! That's where Sylvania will help you sell the "Silver Screen 85"! Hard-selling commercials will tell millions of people every week that you're the man to see for a new "SILVER SCREEN 85."

**YOUR SYLVANIA
DISTRIBUTOR HAS THE
"SILVER SCREEN 85" NOW!
MAKE SURE YOU ARE PART
OF THIS PROFIT-PACKED
PROMOTION—CALL HIM,
WRITE HIM, SEE HIM TODAY!**

SYLVANIA



Sylvania Electric Products Inc., 1740 Broadway, New York 19, N. Y.

In Canada: Sylvania Electric (Canada) Ltd., University Tower Building, St. Catherine Street, Montreal, P. Q.

LIGHTING • RADIO • ELECTRONICS • TELEVISION

newest, neatest, lightest
lapel mike on the market



**THE
TURNER
L-100**

with the adjustable clip
that grips from any angle . . .

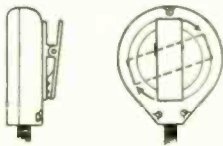

The handiest, low cost lapel mike for all tape recording uses . . . it weighs only 1 ounce and has an alligator clip that really holds. The clip is rubber padded and adjustable — holds the mike where you put it; on draperies, clothing or recorder case. Speech reproduction is crisp, clear-cut with chest sounds damped out. Case is light grey plastic. Crystal and ceramic interiors available. Send coupon for full information.

Model L-100 (with clip and 20-ft. cable) List Price.....\$12.50

Model 100 (with clip and with 7-ft. cable) List Price.....\$8.00



933 17th St. N.E.
Cedar Rapids, Iowa

Please send me complete information on your new Models L-100 and 100.

Name.....

Address.....

City.....

State.....

CORRESPONDENCE

TRAINING PROGRAMS

Dear Editor:

In a recent editorial you urged that bright youngsters be mustered into the radio-electronic field—a sentiment with which I agree wholeheartedly. I am an educator (?) and because I have had some dozen years of teaching experience, I think I know why we will not get the bright boys and girls into our field unless we go after them ourselves.

The "why" is wrapped up in the approach schools—public and private—make to counselling. Students are all too frequently tested for IQ and interests, then influenced to aim at an objective consistent with their abilities, in a field in which their interests lie. Doesn't sound so bad, does it? Unfortunately, the student must express some interest in radio-electronics to be counselled into it. Where does he acquire this interest? In too many cases it isn't available. Simple articles showing a kid how he can make things himself for a few cents are rare today, and it is the bright, underprivileged kid who sometimes becomes a delinquent.

Many counsellors—totally ignorant of the ramifications of the electronic field—assume all bright boys should become engineers, and steer them into an engineering program. Then the boy—frustrated because his hands are not busy on the things his head is learning—gives up and tries something else.

In a small high-school district nearly 10 years ago I added a radio class to the shop offerings. Fourteen boys were entrusted to my care. All but three had long records on the local police blotter. Every cent of the class budget had been spent on the benches. There were no tools, no test equipment, no radio sets nor components, no solder. The local shops provided cast-off dynamic speakers for wire, obsolete sets for parts and tubes. Many parts for the first sets were constructed in the shop. The studies went on in chemistry, physics, radio-electronics, the social sphere.

Not one of the "delinquents" had another mark on his record during his high-school career. Two of them now are nearly engineers, one is starting a doctoral program. Most of the rest are in radio-electronics as a livelihood.

Radio-electronics must be added to every junior high-school curriculum. When even the juvenile delinquent becomes so fascinated by the world openings up to him that he spends his evenings in study and experiment and drops his aggressions, what is its value to the luckier "average" student?

What can be done about it? One thing is to provide material for the present teachers—most of whom read RADIO-ELECTRONICS—and for the bright students, nearly all of whom also see the magazine. The material should include articles and items which will start from virtually nothing and build an understanding by showing how to construct sets, circuits and even components.

CHARLES R. MULKEY

San Jose, Calif.

NOW!



COLOR TV COVERAGE IN PHOTOFACT!

FIRST COLOR TV FOLDER

the RCA Model CT-100

OVER 40 FACT-PACKED PAGES

It's a terrific FIRST—complete data based on actual analysis of the production model...full schematics, block diagrams, parts lists, tube placement, alignment, wave forms, set-up adjustments—*everything* you want to know about this actual color set—information you want and need to get out in front on Color TV!

here's how to get it!

1 Included with Photofact Folder Set No. 252 —out Sept. 1st. You get it in addition to over 100 pages of regular Photofact TV-Radio coverage. Get the Color TV Folder at the regular price of the complete Set... Only \$1.75!

2 You can buy the Color TV Folder separately if you wish. Available from your distributor for only \$1.00!

**GET IT EITHER WAY FROM
YOUR PARTS DISTRIBUTOR**

HOWARD W. SAMS & CO., Inc.

2205 East 46th Street

Indianapolis 5, Ind.

free

1955 VALUE PACKED ALLIED

308-PAGE CATALOG

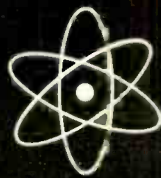

the only COMPLETE
catalog for Everything
in TV, Radio and
Industrial Electronics

SEND FOR IT TODAY

Get ALLIED's 1955 Catalog—308 pages packed with the world's largest selection of quality electronic equipment at lowest, money-saving prices. Select from the latest in High Fidelity systems and components; custom TV chassis, TV antennas and accessories; AM and FM receiving equipment; P.A. Systems and accessories; recorders and supplies; Amateur receivers, transmitters and station gear; specialized industrial electronic equipment; test instruments; builders' kits; huge listings of parts, tubes, tools, books—the world's *most complete* stocks of quality equipment. ALLIED gives you *every* buying advantage: fastest shipment, expert personal help, lowest prices, assured satisfaction. Get the big 1955 ALLIED Catalog. Keep it handy—save time and money on *everything in* Electronics. Send for your FREE copy today.



World's largest Stocks

- All TV and Radio Parts
- All Electron Tube Types
- Test and Lab Instruments
- High Fidelity Equipment
- Custom TV Chassis
- AM, FM Receiving Equipment
- Recorders and Supplies
- P. A. Systems, Accessories
- Amateur Station Gear
- Builders' Kits & Supplies
- Equipment for Industry



ALLIED RADIO free

World's Largest Electronic Supply House

EASY-PAY TERMS

Use ALLIED's liberal Easy Payment Plan—only 10% down, 12 months to pay—no carrying charges if you pay in 60 days. Available on Hi-Fi and P. A. units, recorders, TV chassis, test instruments, Amateur gear, etc.

HI-FI SPECIALISTS

To keep up with the latest and best in High Fidelity, look to ALLIED. Count on us for *all* the latest releases and largest stocks of Hi-Fi equipment. We specialize, too, in TV supply—and are foremost in the field of Builders' Kits.

ultra-modern facilities for the FASTEST SERVICE IN ELECTRONIC SUPPLY



Send for the
leading Electronic
Supply Guide

ALLIED RADIO CORP., Dept. 2-J-4
100 N. Western Ave., Chicago 80, Illinois

Send FREE 308-Page 1955 ALLIED Catalog

Name

Address

City.....Zone.....State.....

precise

says:

Ask ANY Engineer, "WHAT'S THE TOUGHEST TEST OF ALL?"

YOUR test . . . the way the equipment works in actual use . . . under actual conditions. PRECISE test equipment has passed that test countless times . . . every instrument fully proven. That is why YOU and thousands like you have made PRECISE the fastest growing line of test instruments in America today!

Remember, too, PRECISE uses no surplus. See the complete line of PRECISE quality instruments at your jobber now—and save!

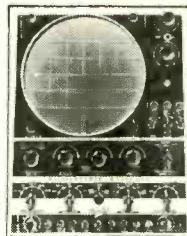

EXCLUSIVE PRECISE 8 1/2" OSCILLOSCOPE
#308K kit form \$129.50
#308W factory wired \$229.50

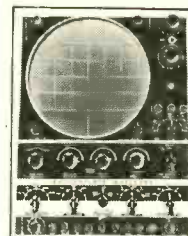

PRECISE 7" OSCILLOSCOPE
#300K kit form \$94.95
#300W factory wired \$199.50

precise ★ precise ★ precise ★ precise

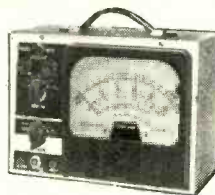

EXCLUSIVE PRECISE VOLT. REG. V.T.V.M.
#9071W kit form \$35.95
#9071W factory wired \$49.95



NEW PRECISE VOLTAGE REG. POWER SUPPLY
#760K kit form \$39.95
#760W factory wired \$59.95

★ precise ★ precise ★ precise ★

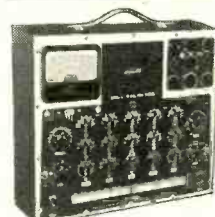

NEW PRECISE Em. & MUT. COND. TUBE TESTER
#111K kit form \$69.95
#111W factory wired \$139.95

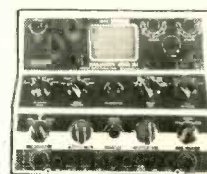

NEW PRECISE 3" PORTABLE OSCILLOSCOPE
#303K kit form \$30.95
#303W factory wired \$49.95

precise ★ precise ★ precise ★ precise ★ precise ★ precise ★ precise



LOWEST PRICED

PRECISE RESISTANCE DECADE BOX
#468K kit form \$18.95
#468W factory wired \$24.95



PRECISE RF-AF-TV & MARKER GENERATOR
#630K kit form \$33.95
#630KA pre-assembled head \$38.95
#630W factory wired \$53.95



PRECISE RF SIGNAL GENERATOR
#610K kit form \$23.95
#610KA pre-assembled head \$28.95
#610W factory wired \$39.95



NEW PRECISE VACUUM TUBE VOLTMETER
#909K kit form \$25.98
#909W factory wired \$37.50

★ precise ★ precise ★ precise ★ precise ★ precise ★ precise ★ precise



LOWEST PRICED

PRECISE CAPACITY DECADE BOX
#478K kit form \$18.95
#478W factory wired \$24.95

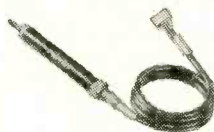

PRECISE RF PROBE
#912 wired only \$4.25
PRECISE CAPACITY ATTENUATOR PROBE
#960 wired only \$5.95



PRECISE UNIV. AF SINE, SQ. & PULSE GEN.
#635K kit form \$33.50
#635W factory wired \$52.50



PRECISE DELUXE VACUUM TUBE VOLTMETER
#907K kit form \$38.98
#907W factory wired \$57.98

cise ★ precise ★ precise ★ precise ★ precise

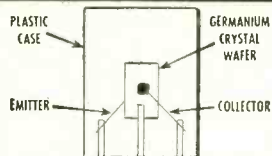

PRECISE NEW T1 TRANSISTOR KIT

PRECISE offers a simple and direct approach to the understanding of transistors. The instruction book covers the physics and practical applications in simple and non-mathematical terms. Two transistors, one germanium diode, transformer, electrolytics, coils, resistors, condensers, chassis, etc. are supplied.

Model T1 kit only \$17.95



PRECISE HIGH VOLTAGE PROBE
#999 wired only \$6.90

precise

DEVELOPMENT CORP.
OCEANSIDE, NEW YORK

Prices slightly higher in the West. Prices and specifications subject to change without notice.

SEND FOR NEWEST PRECISE CATALOG—DEPT. MB-1

Step Into a Higher Paying Position Without
Giving Up Your Present Income



L. C. Lane, B.S., M.A.
President, Radio-Television
Training Association, Executive
Director, Pierce School
of Radio & Television.

**KEEP YOUR
PRESENT JOB AND
TRAIN TO BE A
TELEVISION
TECHNICIAN**



EXPERT FM-TV TECHNICAL TRAINING

My FM-TV Technician Course lets you take full advantage of your previous experience — either civilian or Armed Forces. **YOU CAN SAVE MONTHS OF TIME.** My FM-TV Technician Course completes your training by providing a thorough background in Frequency Modulation and Television Theory and Practice.

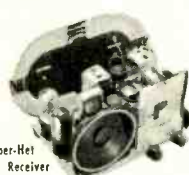

FREE FCC COACHING COURSE

You "Learn by Doing", working with parts and equipment I send you. Six large kits of FM and TV parts are given to you as part of the course. You build and keep a professional **GIANT SCREEN TV RECEIVER** complete with big picture tube (designed and engineered to take any size up to 21-inch).

Upon completion of your training you may — if you desire — take two weeks of shop training at my associate resident school in New York City **AT NO EXTRA COST!**

PRACTICAL TV CAMERAMAN & STUDIO COURSE

My TV Cameraman and Studio Course is designed to train TV Studio Technicians and TV Cameramen, urgently needed today by Television Broadcasting Stations throughout the nation. New TV Stations are now mushrooming throughout the country. Men who can work as Audio Technicians, TV Cameramen, Microphone Boom Operators, Monitor Operators, Turntable Operators, Control Room Technicians can write their own tickets.



I will train you for an exciting high pay job as the man behind the TV camera. Work with TV stars in TV studios or "on location" at remote pick-ups.

Available if you want it . . . one week of actual work with studio equipment and TV Cameras at my associate resident school in New York City.

This course is a **MUST** for those who wish to increase their technical knowledge of television operations.

TRAINING FOR BEGINNERS

My Radio-FM-Television Technician Course is especially prepared for men with no previous experience or training. I have trained hundreds of men for successful careers in radio-television-electronics. Many of them had only a grammar school education and no previous experience whatsoever in the field.

Two weeks of intensive shop practice at my associate resident school is also included with this Course.

Radio **T**elevision **T**raining **A**ssociation

52 EAST 19th STREET • NEW YORK 3, N. Y.

Licensed by the State of New York • Approved for Veteran Training

**I'll train you at HOME
in your SPARE TIME**

If you're now working as a Radio Technician, Maintenance Man, or Operator you can keep your job while studying one of my two **NEW** and **UP-TO-THE-MINUTE** Courses — FM and Television Technician Course — TV Cameraman and Studio Technician Course.

These Courses — especially prepared for home study—will prepare you for top-paying jobs in the ever-expanding radio-television-electronics industry.

Important for **BETTER PAY JOBS** requiring FCC License. You get this training **AT HOME** and **AT NO EXTRA COST.** Top TV jobs go to FCC-licensed technicians.

VETERANS!

My School fully approved to train veterans under new Korean G.I. Bill. Available only to Veterans discharged after June 27, 1950. If eligible, **CHECK COUPON.**

EARN WHILE YOU LEARN

Almost from the very start you can earn extra money while learning, repairing Radio-TV sets for friends and neighbors. Many of my students earn up to \$25 a week . . . pay for their entire training from spare time earnings . . . start their own profitable service business.

YOU GET THESE FOUR FREE!

MAIL THIS COUPON TODAY!

no salesman will call!

Mr. Leonard C. Lane, President
RADIO-TELEVISION TRAINING ASSOCIATION
52 East 19th Street, New York 3, N. Y. Dept. R-9

Dear Mr. Lane: Mail me your **NEW FREE BOOK, FREE SAMPLE LESSON,** and **FREE** aids that will show me how I can make **BIG MONEY** IN TELEVISION. I understand I am under no obligation and no salesman will call.
(PLEASE PRINT PLAINLY)

Name _____ Age _____

Address _____

City _____ Zone _____ State _____

I AM INTERESTED IN:

- Radio-FM-TV Technician Course
- FM-TV Technician Course
- TV Cameraman & Studio Technician Course

VETERANS!
Check here
for Training under **NEW**
G.I. Bill.

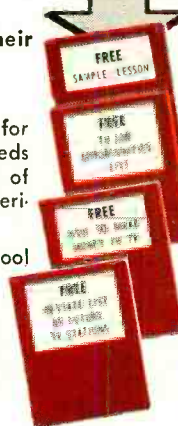

Exclusive!
Electro-Lens
Focusing*!



get sharper...
MUCH SHARPER...
 pictures

Give your customers the most sparkling pictures they've ever hoped for . . . pictures with all the dramatic highlights and tones of a portrait photograph . . . with the revolutionary new Winegard Interceptor TV Antenna! Restores vibrant life to the dull, blurred image of many old sets . . . brings out every last ounce of performance in the newest.

For only the Interceptor has that amazing "Electro-Lens Focusing" . . . the patented design that pulls in all the signal . . . actually builds up its intensity . . . then focuses the amplified signal to the screen, much as an

optical lens focuses and intensifies light rays.

And—the Interceptor gives maximum rejection of side and back interference . . . vastly superior reception in outlying areas. Particularly suited to color TV, designed to give performance unmatched by any other antenna on all VHF channels. Lightweight, compact, wind resistant.

An obsolete antenna can make even the finest set unsatisfactory. So give your customers the best performance from any set, old or new . . . insure their utmost satisfaction. Write for complete information about the Winegard Interceptor Antenna today!

*Patent Pending



WINEGARD *Interceptor*
ANTENNA

with Exclusive Electro-Lens Focusing

WINEGARD COMPANY, 3000 Scotten Boulevard, Burlington, Iowa

Home Study Courses in TELEVISION SERVICING offered by RCA INSTITUTES



Study Television Servicing—from the very source of the latest, up-to-the-minute TV and Color TV developments. Train under the direction of men who are experts in this field. Take advantage of this opportunity to place yourself on the road to success in television. RCA Institutes, Inc. (A Service of Radio Corporation of America), thoroughly trains you in the "why" as well as the "how" of servicing television receivers.

FIRST HOME STUDY COURSE IN COLOR TV SERVICING

Now you can train yourself to take advantage of the big future in Color TV. RCA Institutes Home Study Course covers all phases of Color TV Servicing. It is a practical down-to-earth course in basic color theory as well as how-to-do-it servicing techniques.

This color television course was planned and developed through the combined efforts of instructors of RCA Institutes, engineers of RCA Laboratories, and training specialists of RCA Service Company. You get the benefit of years of RCA research and development in color television.

Because of its highly specialized nature, this course is offered only to those already experienced in radio-television servicing. Color TV Servicing will open the door to the big opportunity you've always hoped for. Find out how easy it is to cash in on Color TV. *Mail coupon today.*

SEND FOR FREE BOOKLET

Mail coupon in envelope or paste on postal card. Check course you are interested in. We will send you a booklet that gives you complete information. No salesman will call.



RCA INSTITUTES, INC.
A SERVICE OF RADIO CORPORATION of AMERICA
350 WEST FOURTH STREET, NEW YORK 14, N. Y.

HOME STUDY COURSE IN BLACK-AND-WHITE TV SERVICING

Thousands of men in the radio-electronics industry have successfully trained themselves as qualified specialists for a good job or a business of their own—servicing television receivers. You can do this too.

This RCA Institutes TV Servicing course gives you up-to-the-minute training and information on the very latest developments in black-and-white television.

As you study at home, in your spare time, you progress rapidly. Hundreds of pictures and diagrams, easy-to-understand lessons help you to quickly become a qualified TV serviceman.

There are ample opportunities in TV, for radio servicemen who have expert training. Mail coupon today. Start on the road to success in TV Servicing.

MAIL COUPON NOW

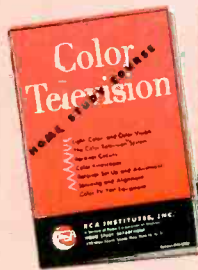

RCA INSTITUTES, INC.
Home Study Dept. RE-954
350 West Fourth Street, New York 14, N. Y.
Without obligation on my part, please send me copy of booklet on:

- Home Study Course in TELEVISION SERVICING.
 Home Study Course in COLOR TV SERVICING.

Name _____ (please print)

Address _____

City _____ Zone _____ State _____

WESTON INTRODUCES NEW LINE OF INSTRUMENTS THAT SIMPLIFY
AND SPEED-UP SERVICING AND ALIGNMENT OF ALL TV RECEIVERS
INCLUDING COLOR. PRECISION BUILT-- DESIGNED TO DEFEAT
OBSOLESCENCE -- PRICED RIGHT FOR SERVICEMEN

WESTON 980 LINE TV TEST EQUIPMENT

In the new 980 Line, WESTON offers TV technicians not only a group of superior, up-to-the-minute instruments, but a new, *greatly simplified* and *time-saving method* of TV receiver alignment as well.

The instruments in this line represent a completely new approach in test equipment design and operation . . . instruments that set entirely new standards in *performance* . . . in *operating simplicity* . . . in *value!*

In the new simplified method of alignment which they provide, it is no longer necessary to connect the calibrator to the receiver. This simplified hook-up eliminates the spurious markers and receiver oscillations encountered with conventional hook-ups. Further, there is no disappearance of markers at trap resonant frequencies. And there are many other advantages, too; all enabling you to do a *better alignment job*, in *one-half the usual time*, and at *far higher profit*.

980 Line instruments are available to TV technicians through leading distributors. Literature giving complete information gladly sent on request. Return the coupon today.



MODEL 985
CALIBRATOR

—a time-saving instrument for TV shop, engineering laboratory, and industrial alignment applications. Negative and positive Z-axis markers are provided for wave-form pattern analysis. Extremely useful for making linearity adjustments, calibrating signal generators, and determining signals of unknown frequencies. Generated markers are visible even at sound trap frequencies. Generated frequencies are *fundamentals* . . . not harmonics. Simultaneous multiple marker insertion . . . no distortion of response curve . . . fewer connections to TV receiver.

MODEL 983
OSCILLOSCOPE

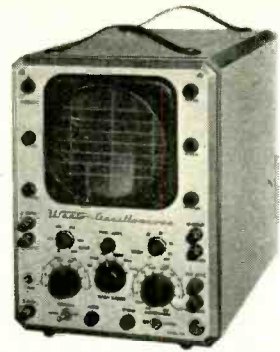

—a high gain, wide band oscilloscope. Band width of 4.5 megacycles allows accurate display of video frequencies, including pulse wave forms and color synchronizing bursts. High sensitivity of 17 millivolts per inch makes it ideal for setting resonant traps, as a general null indicator, signal tracing in low level stages, phase measurements as well as for sweep frequency visual alignment of TV receivers. Has provisions for internal calibration, internal phased sine wave, and Z-axis intensity modulation. Reversal of polarity of both horizontal and vertical signals accomplished by means of toggle switching. Identical vertical and horizontal amplifiers . . . direct coupling used throughout.



MODEL 984
SWEEP
GENERATOR

—for efficient trouble shooting and lab practice in problems of sound and video IF circuits, associated trap circuits, TV tuners, video amplifiers and all-purpose visual alignment. RF OUTPUT: Frequency modulated signal, TV channels 2 to 13 inclusive, complete FM coverage available by means of two preset selector positions. FREQUENCIES ARE FUNDAMENTALS OF THE OSCILLATOR FREQUENCY. IF/VIDEO OUTPUT: Frequency modulated signals ranging to 50 megacycles, continuous tuning, signals free from harmonics. SWEEP WIDTH: Full 10 megacycles on all channels. OUTPUT VOLTAGE (RMS): 0.1 Volt, sweep is linear. Output is essentially flat.

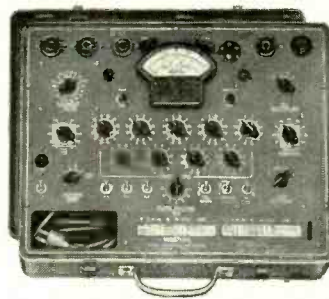

MODEL 981
PROPORTIONAL
MUTUAL CONDUCTANCE
TUBE CHECKER

—provides meter measurement of leakage resistance as high as 5 megohms between tube elements . . . nine single circuit, twelve position selector switches protect against obsolescence . . . three toggle switches make it possible to check and compare sections of twin-section tubes at only one setting of selector switch. Transconductance measurements high as 30,000 micromhos with filtered d-c plate, screen grid, and control grid potentials. Precision voltage divider network and switch provides signal voltages of 0.65, 1.3, 2.6, and 5.2 volts peak to peak at a frequency of 5000 cycles. Tubes checked more closely to circuit operating conditions. Better Gm accuracy obtained.



MODEL 982
VACUUM TUBE
VOLTMETER

—a self-contained, battery operated Vacuum Tube Voltmeter, particularly adaptable to the Radio-TV servicing industry where the requirements of peak to peak measurements of a-c voltages exclude the use of conventional meters. Makes possible quantitative measurement of all complex wave form voltages utilized in video, sync and deflection circuits with no a-c line interference in critical measurements. Battery operation affords complete isolation from spurious response due to stray a-c fields and circulating ground currents. *Circuit loading on peak to peak measurements eliminated.*

MODEL 980
ANALYZER



—highly versatile, accurate and rugged volt-ohm-milliammeter with a combination of functional ranges which provide a wide range of test measurement applications in the electronic field. D-c sensitivity of 20,000 ohms/volt, a-c sensitivity 1000 ohms/volt. Accuracy 2% d-c, 3% a-c. Range and functional switching greatly simplified by use of a single dial for all ranges and functions.

WESTON Electrical Instrument Corporation
614 Frelinghuysen Ave., Newark 5, N. J.

Send copy of bulletin RE

Name _____

Address _____

City _____ State _____

for TV it's the 980 Line
WESTON
test equipment

The
pole
that
need
not
be
climbed



Fastening wires with new tool.

Since telephony began, there has been just one way to install telephone wires on poles: have a trained man climb up and fasten them there. Now Bell Laboratories engineers have developed a special pole line for rural areas. The entire line can be erected without climbing a pole.

The whole job is done from the ground. Light-weight poles are quickly and easily

erected. Newly created tools enable men to fasten wires to crossarms 10 to 25 feet over their heads.

This inexpensive line promises more service in sparsely populated places. From original design to testing, it exemplifies a Bell Telephone Laboratories team operation in widening telephone service and keeping costs down.

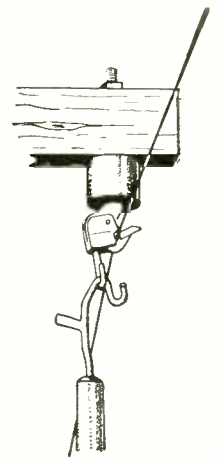

Key to the new "climbless" pole is this insulator. Ground crews use long-handled tools to place the wire in position and then lock it fast.

Bell Telephone Laboratories



IMPROVING TELEPHONE SERVICE FOR AMERICA PROVIDES CAREERS FOR CREATIVE MEN IN SCIENTIFIC AND TECHNICAL FIELDS

I Will Train You at Home

for Good Pay Jobs, Success in

RADIO-TELEVISION

J. E. SMITH
President
National Radio
Institute
Washington, D. C.
40 years of success
training men at
home in spare time.



Practice Broadcasting with Equipment I Send

As part of my Communications Course I send you kits of parts to build the low-power Broadcasting Transmitter shown at the left. You use it to get practical experience putting a station "on the air," performing procedures demanded of Broadcasting Station Operators. An FCC Commercial Operator's License can be your ticket to a better job and a bright future; my Communications Course gives you the training you need to get your license. Mail card below and see in my book other valuable equipment you build.



Practice Servicing with Equipment I Send

Nothing takes the place of PRACTICAL EXPERIENCE. That's why NRI training is based on LEARNING BY DOING. You use parts I furnish to build many circuits common to Radio and Television. With my Servicing Course you build a modern Radio (shown at right). You build a Multitester which you use to help fix sets while training. Many students make \$10, \$15 a week extra fixing sets in spare time starting a few months after enrolling. All equipment is yours to keep. Card below will bring book showing other equipment you build.

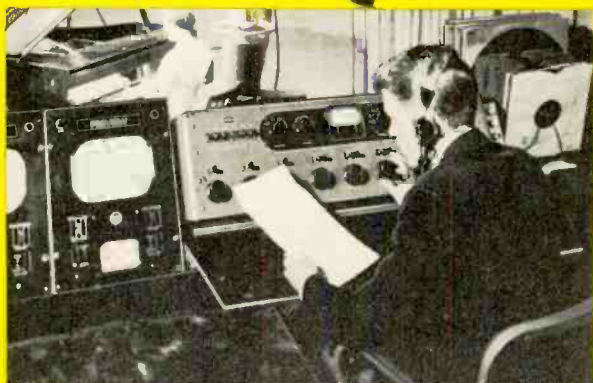
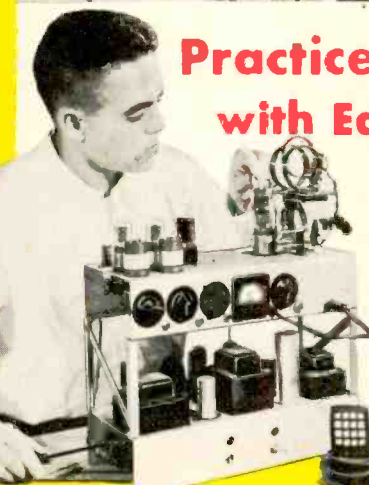

Television is Growing Fast Making New Jobs, Prosperity

More than 25 million homes now have Television sets and thousands more are being sold every week. Well trained men are needed to make, install, service TV sets. About 200 television stations on the air with hundreds more being built. Think of the good job opportunities here for qualified technicians, operators, etc. If you're looking for opportunity get started now learning Radio-Television at home in spare time. Cut out and mail postage free card. J. E. Smith, President, National Radio Institute, Washington, D. C. OUR 40TH YEAR.

AVAILABLE TO
VETERANS
UNDER G.I. BILL

Good Jobs, Good Pay, Success
in Radio-TV! SEE OTHER SIDE

CUT OUT AND MAIL THIS CARD NOW

Sample Lesson & 64-Page Book
Both FREE

This card entitles you to Actual Lesson on Servicing, shows how you learn Radio-Television at home. You'll also receive my 64-Page Book, "How to Be a Success in Radio-Television." Mail card now!

NO STAMP NEEDED! WE PAY POSTAGE

Mr. J. E. SMITH, President,
National Radio Institute, Washington 9, D. C.

Mail me Lesson and Book, "How to Be a Success in Radio-Television." (No Salesman will call. Please write plainly.)

NAME AGE

ADDRESS

CITY ZONE STATE

VETS write in date of discharge

J K L M N O P Q R S

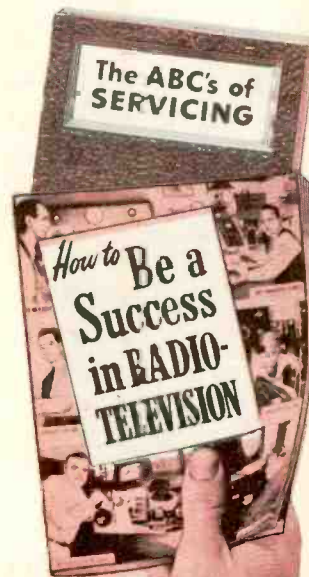

Train at Home to Jump Your Pay as a RADIO-TV Technician



**J. E. Smith, President
National Radio Institute**

The men whose messages are published below were not born successful. Not so long ago they were doing exactly as you are now . . . reading my ad! They decided they should **KNOW MORE . . .** so they could **EARN MORE . . .** so they acted! Mail card below now.

Get a Better Job—Be Ready for a Brighter Future in America's Fast Growing Industry

Training PLUS opportunity is the PERFECT COMBINATION for job security, good pay, advancement. When times are good, the trained man makes the BETTER PAY, GETS PROMOTED. When jobs are scarce, the trained man enjoys GREATER SECURITY. NRI training can help assure you and your family more of the better things of life.

Radio-Television is today's opportunity field. Even without Television, Radio is bigger than ever before. Over 3,000 Radio Broadcasting Stations on the air; more than 115 million home and Automobile Radios are in use. Then add Television. Television Broadcast Stations extend from coast to coast now with over 25 million Television sets already in use. There are channels for 1,800 more Television Stations. Use of

Aviation and Police Radio, Micro-Wave Relay, Two-way Radio communication for buses, taxis, trucks, etc. is expanding. New uses for Radio-Television principles coming in Industry, Government, Communications and Homes.

My Training is Up-to-Date You Learn by Practicing

Get the benefit of my 40 years experience training men. My well-illustrated lessons give you the basic principles you must have to assure continued success. Skillfully developed kits of parts I furnish "bring to life" the principles you learn from my lessons. Read more about equipment you get on other side of this page.

Naturally, my training includes Television. I have, over the years, added more and more Television information to my courses. The equipment I furnish students gives experience on circuits common to BOTH Radio and Television.

Find Out About the Tested Way to Better Pay

Read at the right how just a few of my students made out who acted to get the better things of life. Read how NRI students earn \$10, \$15 a week extra fixing Radios in spare time starting soon after enrolling. Read how my graduates start their own businesses. Then take the next step—mail card below.

You take absolutely no risk. I even pay postage. I want to put an Actual Lesson in your hands to prove NRI home training is practical, thorough. I want you to see my 64-page book, "How to Be a Success in Radio-Television" because it tells you about my 40 years of training men and important facts about present and future Radio-Television job opportunities. You can take NRI training for as little as \$5 a month. Many graduates make more than the total cost of my training in two weeks. Mailing postage free card can be an important step in making your future successful. J. E. Smith, President, National Radio Institute, Washington 9, D. C. OUR 40TH YEAR.

I TRAINED THESE MEN



Consultant on Antenna Systems

"I resigned as Chief Engineer. Now I am on my own as consultant on private and commercial antenna systems." R. J. Bailey, Weston, W. Va.



\$10 a Week in Spare Time

"Before finishing, I earned as much as \$10 a week in Radio servicing, in my spare time. I recommend NRI." S. J. Preuff, Miami, Fla.



Control Operator, Station WEAN

"I received my license and worked on ships. Now with WEAN as control operator, NRI course is complete." R. Arnold, Rumford, R. I.



Has Own Radio-Television Shop

"Doing Radio and Television servicing full time. Have my own shop. I owe my success to NRI." Curtis Stahl, Fort Madison, Iowa.



Radio-Television Service Chief

"Am chief Radio and Television serviceman for large repair shop. Pay very good; working conditions pleasant." P. G. Brogan, Louisville, Ky.



Got First Job Thru NRI

"My first job was with K D L R. Now Chief Engr. of Radio Equipment for Police and Fire Dept." T. Norton, Hamilton, Ohio.

Start Soon to Make \$10 to \$15 a Week Extra Fixing Sets



Keep your job while training. Many NRI students make \$10, \$15 and more a week extra fixing neighbors' Radios in spare time, starting a few months after enrolling. I start sending you special booklets that show you how to fix sets, the day you enroll. The multimeter you build with parts I furnish helps discover and correct troubles.

SEE OTHER SIDE

My Training Leads to Jobs Like These

- | | | |
|-------------------------------|---|------------------------------------|
| BROADCASTING | Service Manager | AVIATION RADIO |
| Chief Technician | Tester | Plane Radio Operator |
| Chief Operator | Serviceman | Transmitter Technician |
| Power Monitor | Research Assistant | Receiver Technician |
| Recording Operator | | Airport Transmitter Operator |
| Remote Control Operator | | |
| | SHIP AND HARBOR RADIO | TELEVISION |
| SERVICING | Chief Operator | Pick-Up Operator |
| Home and Auto Radios | Assistant Operator | Voice Transmitter Operator |
| P.A. Systems | Radiotelephone Operator | Television Technician |
| Television Receivers | | Remote Control Operator |
| Electronic Controls | | Service and Maintenance Technician |
| FM Radios | GOVERNMENT RADIO | |
| | Operator in Army, Navy, Marine Corps, Coast Guard | POLICE RADIO |
| IN RADIO PLANTS | Forestry Service Dispatcher | Transmitter Operator |
| Design Assistant | Airways Radio Operator | Receiver Serviceman |
| Transmitter Design Technician | | |

FIRST CLASS
Permit No. 20-R
(Sec. 34.9, P.L. & R.)
Washington, D.C.

BUSINESS REPLY CARD

No Postage Stamp Necessary If Mailed In The United States

POSTAGE WILL BE PAID BY

NATIONAL RADIO INSTITUTE

16th and U Sts., N.W.

Washington 9, D. C.

CUT OUT—MAIL Postage Free CARD



SAMPLE LESSON and 64-PAGE BOOK Both FREE

Have Your Own Business

Many NRI trained men start their own successful Radio-Television sales and service business with capital earned in spare time. Joe Travers, a graduate of mine, in Asbury Park, N. J., writes: "I've come a long way in Radio and Television since graduating. Have my own business on Main Street."





Don't waste time and money hunting for exact replacements or waiting for delivery of out-of-stock items!

Making the most of Centralab's new Fastatch* Custom Controls?

Unique plan keeps 4,000 combinations of resistance and taper **IN STOCK at your Centralab distributor**

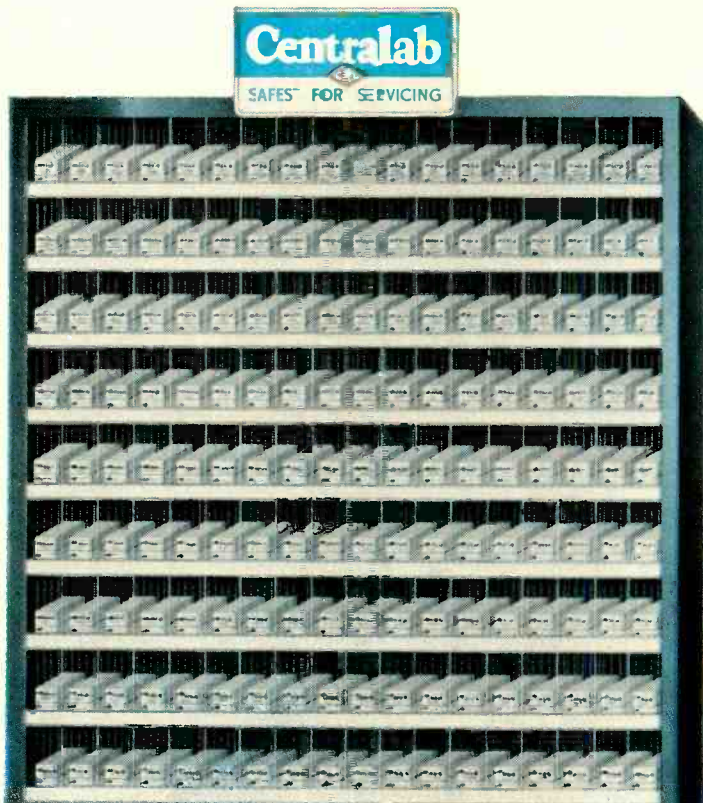

Never before has it been so easy to get the right replacement for practically any dual control, current or future (including color TV)!

With Centralab's new custom-control system, you take Fastatch front and rear units and simply do this:

Snap front unit...
(with outer shaft cut to length)

To rear unit...
(with blue shaft cut to length)

Snap on switch...
(from Fastatch KB series)

Add the knobs
—and there's your custom dual



Note that you don't do the manufacturer's job —there are no loose parts . . . no lugs to bend . . . no tricky assembling. Fastatch units are completely assembled, tested, and guaranteed by Centralab.

Have your Centralab distributor tell you more. And send coupon for bulletin 42-218.

Centralab

Tear out coupon and mail today!

CENTRALAB, A Division of Globe-Union Inc.

9221 E. Keefe Avenue, Milwaukee 1, Wisconsin

Send me free bulletin 42-218.

Name.....

Company.....

Address.....

City..... Zone..... State.....

B-3854

*Trademark

See For Yourself!

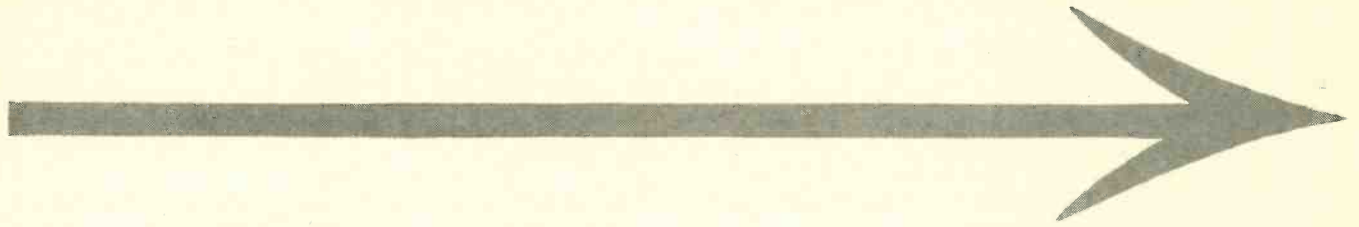

New!

PHILCO

SUPER PERFORMANCE



ANTENNAS



GUARANTEED TO OUTPERFORM ANY EQUIVALENT TYPE ANTENNA OR YOUR MONEY and LABOR COSTS BACK!

There's been enough words written about TV antenna performance. Now . . . *see the facts for yourself!* Compare any of the new PHILCO Super-Performance TV Antennas with any equivalent type on the market. If the new PHILCO does not give you the finest picture possible, your money back for the antenna *plus* your labor costs up to \$10.00. Ask your PHILCO Distributor for complete details on this amazing offer!



PHILCO VHF
SUPER CONICAL

PHILCO TWO-BAY SUPER CONICAL ALL-CHANNEL ANTENNA

Strong signal pickup on VHF channels 2 through 13 . . . UHF channels 14 through 83 . . . ideal for fringe area reception . . . all-aluminum construction with dowelled elements: Part No. 45-3096-2. Rugged single bay design: Part No. 45-3096.

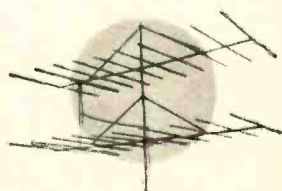

PHILCO VHF
LOW BAND YAGI

PHILCO TWO-BAY VHF LOW BAND YAGI ANTENNA

10 elements . . . all-aluminum . . . factory pre-assembled. Top performance on channels 2 through 6 . . . 13 db to 15 db gain on various channels. Single bay Part No. 45-3112-2 through 6. Stacked version harness Part No. 45-3267.

PHILCO GOLDEN YAGI UHF ANTENNA

Designed for 300 ohm operation . . . all metal construction . . . 11 db to 12 db gain on various channels. "Cronak" coated components resist salt air . . . humidity. Six models cover entire UHF spectrum: Basic Part No. 45-1996.



PHILCO UHF
GOLDEN YAGI

PHILCO PARAFLECTOR ALL-CHANNEL UHF ANTENNA

Pre-assembled, all-aluminum . . . 8 to 10 db gain . . . outstanding fringe area performance . . . immediate mounting on existing masts. Part No. 45-3071. Bow Tie, Part No. 45-3069 and Bow Tie with reflector, Part No. 45-3070 give top quality pictures in many UHF areas.



PHILCO UHF
PARAFLECTOR

PHILCO CORPORATION ACCESSORY DIVISION

"A" AND ALLEGHENY AVE. • PHILADELPHIA 34, PA.

NOW... 2 SENSATIONAL EICO SCOPE VALUES!

NEW AMAZING FEATURE PACKED

7" PUSH-PULL OSCILLOSCOPE

Only EICO Has All These Features

- VERTICAL FREQ. RESPONSE: flat ± 2 db 10 cps - 1 mc
- VERTICAL SENS.: .01 volts rms/inch
- HOR. FREQ. RESP.: flat ± 0 db 10 cps - 200 kc, -4 db at 500 kc
- HOR. SENS.: .3 volts rms/inch
- SWEEP RANGE: 15 cps-100 kc
- 3-STEP FREQ.-COMPENSATED ATTENUATOR eliminates freq. distortion, overloading.
- CATHODE FOLLOWER inputs to both amplifiers
- PUSH-PULL outputs in both amplifiers
- RETURN TRACE BLANKING
- INT. VOLTAGE CALIBRATOR
- V & H TRACE EXPANSION & CENTERING: 1.5X full screen without distortion.
- DIRECT CONNECTION to vert. CRT plates.
- PHASING CONTROL of internal 60 cps sine wave sweep.
- AT FRONT PANEL: intensity mod. input; 60 cps, sawtooth outputs.

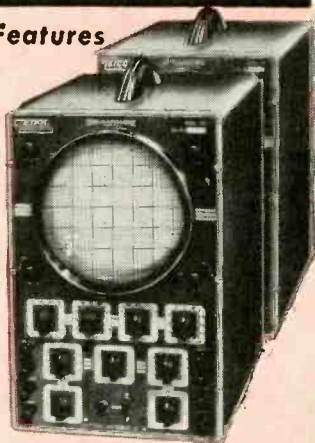

MODEL 470K
KIT \$79.95. WIRED \$129.50.

EICO EXCLUSIVE! 5" PUSH-PULL SCOPE, 425K, Amazing feature-packed economy-priced

- PUSH-PULL V & H amplifiers. Sens: 0.5-.1 rms v/in. Useful to 2.5 mc.
- SWEEP. 15 cps-76 kc. Z-axis intensity modulation. Dual trace positioning controls.



SCOPE VOLTAGE CALIBRATOR KIT
495K KIT \$12.95. WIRED \$17.95.

- Sq. wave output at power-line freq. with full-scale readings of 1, 1, 10 or 100 V. peak-to-peak
- Accuracy $\pm 5\%$ of full-scale on each range.

6V & 12V BATTERY ELIMINATOR KIT 1050K KIT \$29.95. WIRED \$38.95.

- DC output: 0-8 V or 0-16 V.
- Continuous current rating: 10 A at 6 V, 6 A at 12 V.
- Intermittent current rating: 20 A at 6 V, 12 A at 12 V.
- Separate Voltmeter & Ammeter.



221K VTVM KIT \$25.95. WIRED \$39.95.

- AC/DC volts: 0-5, 10, 100, 500, 1000 (30 kv with HVP probe)
- Res.: 0.2 ohms-1000 megs, 5 ranges
- DC input R: 25 megs
- 4 1/2" meter in can't burn out circuit
- 1% mult. resistors
- HIGH VOLTAGE PROBE \$4.95
- Extends range of VTVMs & voltmeters to 30 kv.



360K SWEEP GEN. KIT \$34.95. WIRED \$49.95.

- Continuous coverage of all TV & FM freqs. from 500 kc to 228 mc.
- Sweep width variable 0-30 mc.
- Crystal marker oscillator, variable amplitude.

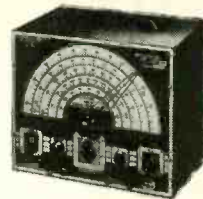

630K CATHODE RAY TUBE CHECKER KIT \$17.95. WIRED \$24.95



- Checks all types of TV picture and C.R. tubes in the set or carton. Bridge measurement of peak beam current (proportional to screen brightness).
- Detects shorted & open elements

625K TUBE TESTER KIT \$34.95. WIRED \$49.95.

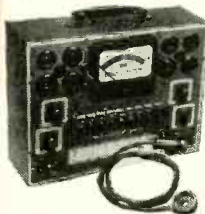

- Illum. gear-driven "Speed Rollchart."
- New lever-action switches for individual testing of every element.
- Tests all conventional & TV tubes.
- PIX TUBE ADAPTER for Tube Testers \$4.50. Checks TV picture tubes while in set.

214K VTVM KIT \$34.95. WIRED \$54.95.



- Large 7 1/2" meter, can't-burn-out circuit.
- AC/DC volts: 0-5, 10, 100, 500, 1000 (30 KV with HV Probe).
- 5 ohms ranges from .2 ohm to 1000 megs.
- DC input R: 25 megs.
- 1% mult. resistors.

Large 7 1/2" meter

950B-K R-C BRIDGE & R-C-L COMP. KIT \$19.95. WIRED \$29.95.

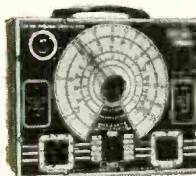

- Measures & tests all resistors; .5 ohm to 500 megohms.
- Every type condenser, 10 mfmf to 5000 mfd.
- 0-500 DC voltage source for capacitor leakage testing.

NOW! ONLY TEICO-KITS & WIRED INSTRUMENTS Gives You LIFETIME SERVICE & CALIBRATION GUARANTEE*

*at less than our cost of handling (See EICO Guarantee Card enclosed with each Kit & Instrument).

352K BAR GENERATOR KIT \$14.95. WIRED \$19.95

- Reliable, accurate, portable, easy-to-use.
- Operates on channels 2-6. 16-23 vert. bars to check H linearity. 13-22 hor. bars to check V linearity.
- Shows pic size & V & H sync circuit stability.
- Entirely independent of station sent signals.



Prices 5% higher on West Coast. Specifications and prices subject to change without notice.

New! EICO SCOOPS!

232K PEAK-to-PEAK VTVM with DUAL-PURPOSE AC/DC Uni-Probe[®] KIT \$29.95 WIRED \$49.95



Measures directly p-p voltage of complex and sine waves: 0-4, 14, 42, 140, 420, 1400, 4200 V DC/RMS sine voltage range: 0-1.5, 5, 15, 50, 150, 500, 1500 v. Ohms: 0-1000 megs. 7 non-skip ranges on every function. Calibration without removing from cabinet. Zero center. Freq. Resp. 30 cps-3mc. 1% precision ceramic multipliers. Exceptional stability and accuracy. Compact, portable (8 1/2 x 5 x 5"), smart, rugged.

NEW! UNI-PROBE! Terrific time-saver! Only 1 probe for all functions—a half-turn of probe-tip selects DC or AC (Peak-to-Peak or RMS) / OHMS!

249 K PEAK-to-PEAK VTVM with 7 1/2" METER KIT \$39.95 WIRED \$59.95

944 K FLYBACK TRANSFORMER AND YOKE TESTER Kit \$23.95 WIRED \$34.95

Tests all flybacks and yokes, in or out of TV set—in just seconds! Detects even 1 shorted turn!

Exclusive separate calibration for air- and iron-core flybacks assures utmost accuracy. Large 4 1/2" meter, 3 colored scales. Compact, portable (7 x 5 x 4"), smart, rugged.

- 488K ELECTRONIC SWITCH KIT \$23.95. WIRED \$39.95
- 1171K DECADE RESISTANCE BOX KIT \$19.95. WIRED \$24.95
- 1180K DECADE CONDENSER BOX KIT \$14.95. WIRED \$19.95



315K DELUXE SIG. GEN. KIT \$39.95. WIRED \$59.95.

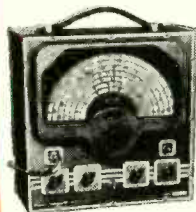

- Covers range of 75 kc to 150 mc.
- 7 calibrated scales: accuracy better than 1%.
- Bandspread vernier tuning.
- 4-step RF shielded output multiplier: constant output Z.

377K SINE & SQUARE WAVE AUDIO GEN. KIT \$31.95. WIRED \$49.95.



- Complete sine wave coverage, 20-200,000 cps in 4 direct-reading ranges.
- Complete square wave coverage, 60-50,000 cps.
- Cathode follower output circuit.

536K MULTIMETER KIT \$12.90. WIRED \$14.90.



- 1000 Ω /V; 31 ranges
- DC/AC volts: Zero to 1, 5, 10, 50, 100, 500, 5000.
- DC/AC Current: 0-1, 10 ma; 0.1, 1 A.
- Ohms: 0-500, 100 K, 1 meg.

565K MULTIMETER KIT \$24.95. WIRED \$29.95.



- 555K MULTIMETER KIT \$29.95. WIRED \$34.95. (1% precision resistors)
- 20,000 Ω /V; 31 ranges.
- DC/AC/Output volts: 0-2.5, 10, 50, 250, 1000, 5000.
- DC Current: 0-100 ua; 10, 100, 500 ma; 10 A.
- Ohms: 0-2K, 200K, 20 meg.

145K SIG. TRACER KIT \$19.95. WIRED \$28.95.

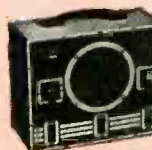

- Audibly signal traces all IF, RF, Video & Audio circuits from ANT to SPKR or CRT in all TV, FM, AM, etc. without switching.
- Germanium crystal diode probe responsive to over 200 mc.
- Integral test speaker.

320K SIG. GEN. KIT \$19.95. WIRED \$29.95



- Vernier tuning condenser.
- Stable Hartley RF osc. range: 150 kc to 34 mc, calibrated harmonics to 102 mc.
- Pure or modulated RF, & Colpitts oscillator 400 cps sine outputs.
- 322K SIG. GEN. KIT \$23.95. WIRED \$34.95. (As above, plus individual calibration of each of its 5 bands)

Write Now for FREE latest Catalog C-9



©1954

Separate Assembly & Operating Manuals supplied with each EICO KIT!

You build EICO Kits in one evening, but... they last a lifetime!

SAVE OVER 50%! See the famous EICO line TODAY, at your local jobber.

ELECTRONIC INSTRUMENT CO., Inc., 84 Withers Street, Brooklyn 11, N. Y.

AUTOMATION

... Electronic Hands are fast superseding human ones ...

AUTOMATION, a recent word coined to designate an old art, is taking the modern electronic world by storm. *Automation*, stripped bare of its technicalities, simply is the use of a robot-like machine which can do a given job better and faster than is possible for any human. Automation also outrivals all humans because it can stay on the job for 24 hours a day, if necessary, without a break. It doesn't tire or loaf on the job.

Ideal automation envisages a factory with few or no humans—the raw materials flowing in at one end, the finished product (packed and crated) leaving by truck or rail at the other.

Automation is not new. It ushered in the Industrial Revolution in England when a number of inventions were perfected in the 18th Century. These were responsible for the Textile Revolution based upon the flying shuttle invented by John Kay in 1733; the spinning jenny by James Hargreaves in 1770; the roller spinning frame patented by Richard Arkwright in 1769 and the "mule" invented by Samuel Crompton in 1779. These enabled English factories to duplicate fine muslins formerly produced by laborious, slow Indian handwork at a rapid rate. (Hand weaving was the main English and Indian industry.) The resultant effect of these automatic new machines was so devastating that tens of thousands of factory workers were made idle, causing great distress and resentment. Much later, of course, workers learned that automation creates more work, more jobs due to increased trade, which in turn creates new prosperity.

Today automation is all around us: the dial telephone is an excellent example, because it is almost 100% automatic. Electric current production—particularly when generated by water-power—automatic elevators, signal lights in our city streets, the teletype, paper-making machines and countless others.

Add to these, thousands of automatic machines that turn out myriads of mass-produced articles, such as screw-machine products; machines that stamp, draw, press, form articles of metal, paper, plastic, glass, fabric, yarn, thread—and combinations of these.

Ever since its start over 30 years ago, radioelectronics has actively pursued automation. We started by winding single inductance coils by hand. Soon we made 50 and more simultaneously by machine. The same was true of capacitors wound of insulating paper and metal foil. From here to the automatically produced transistor is but a short future step. Indeed one would be hard-pressed to name a single radioelectronic component that is not now or will not soon be mass-produced automatically. Even such a tremendously complex component as the TV color picture tube is beginning to be mass-produced as this is being written.

From mass-producing components to the automation of complete radio and television receivers was an inevitable step. In 1947 an English firm had already produced a complete radio receiver on an automatic assembly line—the parts fed in at one end, the complete radio emerging at the other, without a human hand touching the growing receiver

in transit through the robot-machine. (See our September 1947 issue for details.)

It comes therefore as no surprise that a large Chicago radio and TV manufacturer has announced the actual building by this fall of a line of 30% finished, automatically assembled 21" television receivers. At a cost of over \$250,000 an automation machine was built whereby radio-electronics components are fed in at one side, while a partly assembled TV chassis is pushed off the line.

The robot-produced TV chassis is the answer to the otherwise prohibitively high price of color TV. Manufacturers, it seems, learned rapidly that multichrome TV sets at \$1,000 and over just do not sell readily by the million, particularly if you can buy a good 21-inch black and white set for less than \$200.00. It would seem certain—if we consider the economics of today's manufacturing, with its ever rising labor costs—that automation in radio and TV receiver production is not only here to stay, but will keep accelerating rapidly in the immediate future. We endorse it as an important step in the right direction.

Nevertheless, at this point we feel it our duty to sound a sharp warning, before TV set automation has become irremediably fixed. It was the elder John Pierpont Morgan who once sagaciously remarked, with a finality that has never been challenged to date:

"YOU CANNOT UNSCRAMBLE AN OMELET"

In applying this reasoning to our future, indescribably complex, automatically produced color TV chassis, we are concerned what will happen if our robot engineers do not keep a constant vivid servicing picture before them. The engineers' temptation to build an efficient automation production line is a most powerful and compelling lure. He must sacrifice many things to achieve speed in assembling, smooth flow, efficiency, foolproof connections—to mention only a few essentials—of the final assembled chassis.

It is only natural therefore that he may not—in such a complex undertaking—give too much thought to the service technician, who later on must repair and put in order even the best engineered receiver. Will all the parts be accessible readily? Can they be replaced in a reasonable amount of time—or will it be necessary to tear the whole chassis apart?

If hand-assembled TV chassis in the past have—in some models—proved servicing nightmares, how much more will machine produced—infinity more complex—color TV receivers become? Will they be so difficult to service that the average servicing technician will refuse point blank to touch them? If this is true of certain black and white TV sets today, how much truer must it become with future automation produced color TV sets? In the last instance the public will learn how to avoid buying such unserviceable receivers.

May we therefore, earnestly impress our automation engineering fraternity to give a great deal of consideration to the servicing phase and its problems—before automation is finally frozen irrevocably.

A TV SET IS ONLY AS GOOD AS ITS SERVICEABILITY

MATCH YOUR SPEAKERS

the easy way...

How to calculate and use the 70-volt line

By RICHARD H. HOUSTON

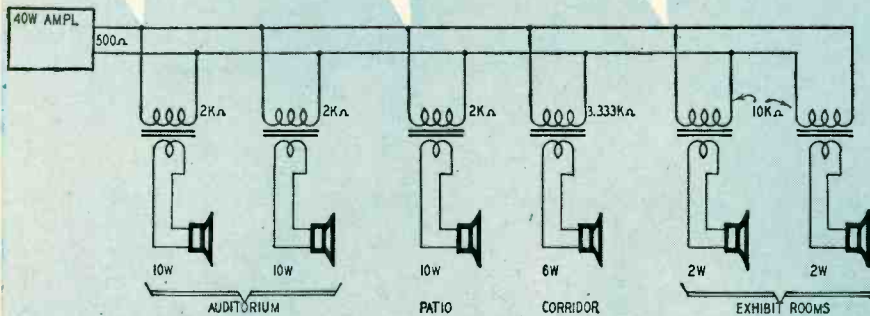

Fig. 1—Diagram shows power distribution in a conventional installation.

A FRIEND of mine had just gone over his budget to buy two high-fidelity public-address horn speakers rated at 25 watts each, according to the catalog. Now he was dismayed to find the 1,000-ohm terminals clearly labeled "5 watts." Since he had to match a 500-ohm line with the two speakers in parallel, he was obviously limited to 10 watts output instead of the desired 50, or so he thought. This true story had a happy ending, because I was able to assure my unhappy friend that his speakers were good for 50 watts total. Then why the 5-watt label? It's really no mystery.

Many technicians seem to be unaware of a relatively new system which greatly simplifies the problem of matching several speakers to an amplifier, especially when the speakers must accept different amounts of power. The most complicated matching problem can be solved in a short order with no mathematics beyond simple addition. Known as the constant-voltage system, this method was standardized by the RMA (now RETMA) several years ago but has never reached its deserved popularity.

The old way

Before investigating *how* the system works, let's see what it will do. Assume that you, a public address operator, have landed a lucrative contract to supply sound facilities for a small convention in your town. The setup is to provide background music and announcements during the day as well as sound reinforcement for the guest speakers on the evening program. Furthermore your contract calls for changes to be made in the speaker arrangement at a moment's notice depending upon requirements that might develop during the convention. You

survey the problem and decide to place speakers in the main auditorium, two exhibit rooms, a corridor, and an outdoor patio. Obviously the audio volume requirements will be different in the various locations.

You plan to use a 40-watt amplifier and decide that a fair distribution of power would be: auditorium, 10 watts into each of two speakers; exhibit rooms, 2 watts each; corridor, 6 watts; patio, 10 watts. Just to be conventional you select an amplifier output impedance of 500 ohms and then begin determining how to match each speaker. The calculations aren't difficult, but they *do* take time.

Now comes the mathematics—but not too much. You probably have your own set of formulas, but this is the most simple:

$$\text{Speaker impedance} = \frac{\text{amplifier power} \times \text{line impedance}}{\text{speaker power}}$$

From this formula the impedance of the 10-watt speakers is:

$$\begin{aligned} \text{Speaker impedance} &= \frac{40 \times 500}{10} \\ &= \frac{20,000}{10} = 2,000 \text{ ohms.} \end{aligned}$$

The other impedance, from the formula, are: 6-watt speaker, 3,333 ohms; 2-watt speakers, 10,000 ohms.

Your complete system is shown in Fig. 1.

If you care to check your results, you may calculate the impedance of all the speakers in parallel using the simple parallel resistance formula. The result should be the amplifier output impedance. The speaker impedances can be obtained by using line-to-voice-coil transformers with the required

primary impedances. Of course you will have to compromise and select the nearest obtainable values on your transformers.

Now that wasn't difficult, was it? If you're lucky you even have time to do the figuring in the shop before you go out on the installation. But don't forget that agreement to change things at a moment's notice! The evening program is about to start and attendance is away over what was anticipated. A harried committeeman appeals for help. The exhibit rooms must be used to handle the auditorium overflow. Can you pipe the speech into these rooms—but not into the corridor or patio, which another group is now using? The guest big shot is about to speak at this minute—for Pete's sake, DO SOMETHING—QUICK!

We leave you now, with your formulas, paper, pencil, maybe even a slide rule. Good luck—your reputation depends on your bearing up under the strain. When it's all over and you feel up to it, look into the constant-voltage matching system. All you need to do is to add a few simple figures—you can do it in your head—to set up any combination of speakers. Does it sound simple? It is!

The new way

Perhaps you have noticed in the catalogs or on your own amplifiers, in addition to the customary output impedances, a constant-voltage output of 70 volts (Fig. 2). You might have wondered how a constant voltage is obtained, since the output voltage certainly must vary with different levels of sound output. There's no trick. The constant-voltage output is merely a tap on the output transformer, in many cases the same tap as one of the output impedances. Why, then, call it constant voltage?

It's like this—the output transformer secondary is tapped at some point which will deliver 70 volts a.c. when the amplifier is operating at its *rated* power output. Whether it be a 2-watt, 10-watt, 50-watt, or 500-watt amplifier, the transformer is tapped so that full power output will deliver 70 volts at

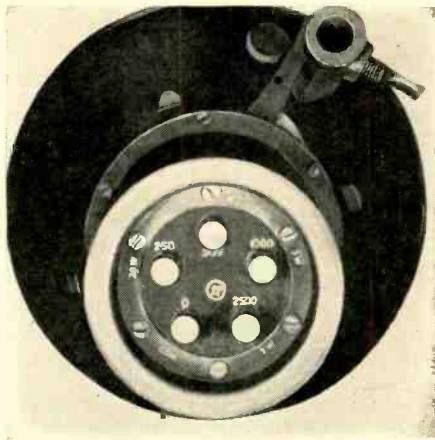

Military surplus speaker labelled for use in constant-voltage matching system.

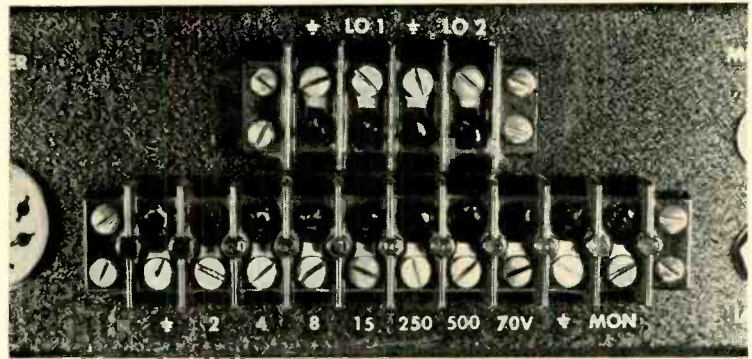

Fig. 2—Output terminal board for 20-watt amplifier. The terminal marked "70 V" is actually connected internally to the 250-ohm output terminal.

the constant-voltage tap. Thus the voltage is constant in the sense that it is the same for all amplifiers operated at full output rating. The voltage is actually a bit over 70.7, or the square root of 5,000, but for simplicity it is usually called 70 volts.

Now here's how the constant-voltage system simplifies an installation, if you will pardon a bit more math. To find the power dissipated by a certain impedance, you square the voltage (multiply it by itself) and divide by the impedance, or:

$$\text{power} = \frac{(\text{voltage})^2}{\text{impedance}}$$

Regardless of the output power of the amplifier you use, if it has a constant-voltage output, the numerator of this equation will always be 70.7², or 5,000. Notice what this means. A certain impedance speaker, or line-to-voice-coil transformer will *always* take the same power, whether you connect it to your little 10-watt amplifier or your big 100-watt booster. Then there's no reason why that speaker or transformer can't be labeled directly in watts instead of in ohms! See what this is leading to?

In the constant-voltage system all matching is done in terms of power. You need no formulas. All you need to do is to be sure all the speakers add up to the *rated* power of the amplifier, tie them to the line, and you're ready to roll!

Let's go back to the convention, but this time we'll use the constant-voltage system. The estimates of power requirements will be the same—a watt is a watt in either system. We select a 40-watt amplifier and connect the speaker distribution line to the 70-volt output. Our power requirements were selected to add up to 40 watts, so we merely connect the auditorium and patio speakers on their 10-watt (500-ohm) terminals, the corridor speaker on its 6-watt (850-ohm) terminals, and the exhibit room speakers on their 2-watt (2,500-ohm) terminals. That's it—let the convention begin!

Depending on what matching transformers you have on hand, you may have to juggle powers a bit to make things come out even. If, for example, you have no transformer with a 6-watt tap, you could use a 5-watt tap for the corridor speaker with insignificant mismatch. If a 3-watt tap were available, you could send that extra watt from the corridor to one of the exhibit rooms, and *exactly* match the system again—still with no calculations beyond simple addition!

The same harried committeeman dashes up, out of breath, demanding that you DO SOMETHING. You do—immediately. You merely reconnect the auditorium speakers on their 15-watt terminals, tie in the exhibit rooms for 5 watts each—adding up to 40 watts—and the big shot speaks without delay!

Of course, the full power output of the amplifier need not be used. If the amplifier gain is adjusted for half power, each speaker will take half the power indicated by its terminals. However, the *rated* power must be used in the matching calculations.

Equipment

Most modern PA amplifiers are equipped with a 70-volt output terminal. A complete assortment of matching transformers is also available from the leading transformer manufacturers. If you are just starting out in the PA field, it would be wise to consider the advantages of the system before buying your equipment. You will find other accessory equipment especially suited to the specifications of the constant-voltage system.

One manufacturer, for example, markets an instrument with which it is possible to determine directly the power required for any given speaker installation. This device is essentially a calibrated attenuator and dummy load. It is connected to the 70-volt tap of any amplifier and the speaker is connected to the output terminals of the instrument. With the amplifier delivering the actual program material to be used, a calibrated dial is ad-

justed for desired volume from the speaker. The dial then indicates the power required to produce that volume.

Converting present system

If you already have a large inventory of equipment, but would like to take advantage of the constant-voltage system, you still may do so. Some of your amplifiers may already have a standard 70-volt output, even though they are not so marked. The table shows the impedance tap that will deliver 70 volts for a typical amplifier:

Amplifier rating (watts)	Output impedance (ohms)
5	1000
10	500
20	250
25	200
40	125
50	100
100	50

If, for example, you have a 25-watt amplifier with a 200-ohm output, mark that output terminal "70 volts" and you will have a standard constant-voltage output.

The table works in reverse, too. You may "modernize" your speakers and matching transformers by marking the listed impedance taps with the corresponding powers. A 500-ohm terminal, for example, would be marked 10 watts. The power rating for any impedance not listed in the table may be determined from the formula given earlier in this article.

If your amplifiers have no output impedances which fit into the standard scheme, you still may be able to do something about it. Maybe your amplifiers have only voice-coil impedance outputs. For an 8-ohm tap to be a 70-volt output, the amplifier would have to be rated at 625 watts! The best solution in this case is to use a line-to-voice-coil transformer in reverse. For a 10-watt amplifier the table shows that a 500-ohm output will deliver 70 volts. A 500-ohm-to-8-ohm transformer, with its voice-coil winding connected to the 8-ohm amplifier terminals, will convert such an

AUDIO—HIGH FIDELITY

amplifier to the standard constant-voltage system.

One other possibility exists. If you have only one amplifier, or several identical amplifiers, you may set up your own nonstandard constant-voltage system. Since such a system could not be used in conjunction with standard components, such a step should be taken only if no future expansion of facilities is anticipated. To set up your own system, choose an output impedance tap nearest that which would match the standard system (since the 70-volt standard is a good practical level). Calculate the voltage at this tap when the amplifier is delivering full rated power. This is your own "standard" output voltage. Next determine what power will be taken by your speakers when they are connected across this output voltage. Label the amplifiers and speakers, and you're in business. An example will clarify the calculations.

Say you have several 30-watt amplifiers with output impedances including 2, 4, 8, 15, 200, and 500 ohms. Your speaker matching transformers have taps for 100, 200, 333, 500, and 1,000 ohms. The table shows that the available impedance nearest the standard system is 200 ohms. An output of 30 watts into a 200-ohm impedance produces 77.5 volts, as determined from the formula:

$$\text{voltage} = \sqrt{\text{power} \times \text{impedance}}$$

Using this value of voltage in the formula given earlier, you determine the following:

Impedance	Power
1,000	6
500	12
333	18
200	30
100	60

With your new "standard" system, you could make up the following combinations of speakers, all of which would add up to 30 watts:

- one 30-watt
- one 18-watt and two 6-watt
- one 18-watt and one 12-watt
- five 6-watt
- two 12 watt and one 6-watt
- three 6-watt and one 12-watt

The mathematically minded technician will quickly spot the fact that the old impedance-matching system and the newer constant-voltage system accomplish exactly the same purpose. The constant-voltage system simply nails down one variable factor, that of the amplifier output, and thereby reduces the problem to extremely simple proportions. It should be clear now why the befuddled gentleman in the opening story was worried unnecessarily about his expensive PA trumpets! If you have been similarly confused, maybe you are straightened out now and can put the constant-voltage system to work for you. It's a cinch—why not try it?

END

Low-Drain Hearing Aid

Transistors require little power

TRANSISTORS have distinguished themselves in many fields, but in none more than that of hearing aids. Their small size and low power-supply demands have produced a complete new line of ultra-compact instruments. Even more important, the low power requirements have made hearing aids vastly more economical to operate. Since a hearing aid user may keep the device on during the wearer's whole waking period, battery expense with old-style instruments is no small item.

One of the latest, the Zenith Royal-T, uses a single 1.5-volt cell, which will last approximately one month. This aid uses three CK-718 PNP junction transistors in a grounded-emitter circuit, with special magnetic microphone and earphone. A phone magnet makes telephone conversations easy.

A small slide switch on the side of the case switches from the microphone to the built-in inductive type telephone pickup coil. Sounds are picked up by holding the hearing aid close to the telephone receiver or close to the bottom of the cradle.

The tone-control switch is a special type that is a bit more complex than the diagram illustrates. It is set into the top of the case on the opposite edge from the volume control. In the diagram, the switch is shown in the



The Zenith Royal-T hearing aid.

full-range position. In the next position, high, the 1- μ f capacitor is grounded. In the medium position, the 1- μ f and the .001- μ f capacitors are both grounded. When the switch is turned to low, the .001- μ f capacitor is grounded while the 1- μ f unit is not, although this is not possible with the simplified switch diagram in the manufacturer's schematic shown here.

The unit also includes a miniature circuit-transfer type jack that is used with an external microphone. The built-in unit cuts out automatically when the external unit is plugged in. END

Right, low power requirements of hearing aid permit operation on a single 1.5-volt cell.

Below, schematic diagram of the Zenith Royal-T hearing aid, and layout of CK-718 terminals.

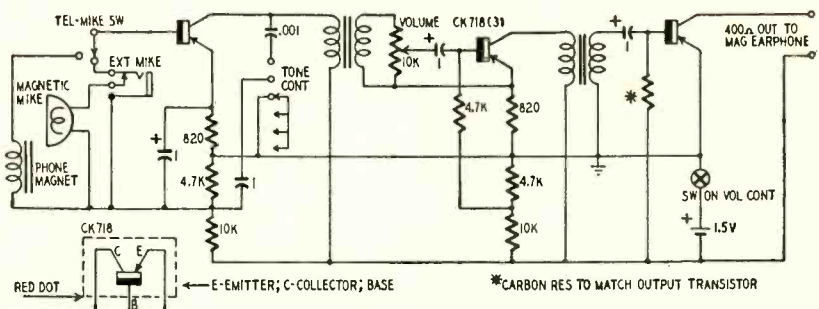

FOR GOLDEN EARS ONLY

A review of the latest in audio components and recordings of interest to the hi-fi enthusiast

By MONITOR

D. T. N. Williamson, whose amplifier has become the international hi-fi workhorse, has come up with another notable—and in some respects revolutionary—design in the ribbon pickup being produced and distributed by Ferranti of Great Britain.

The frequency response of the Ferranti is flat from 20 to 20,000 cycles and extends for a considerable range on each end. Indeed, the high-frequency response is limited principally by the transformer and amplifier into which it is fed, since the transducer itself has some response for a couple of octaves beyond 20 kc. On the low end, it is still so flat at 20 cycles that (though I have no means of measuring it) I suspect it goes down at least another octave. In any case the over-all bandwidth not only embraces the entire audible range but complements that of our better amplifiers. This extended response is not directly apparent to the ear since very few recordings possess much material above 12 or 15 kc and below 30 or 40 cycles; but it does seem to me to result in a cleaner reproduction of such severe transients as those on the Cook *Fiesta Flamenca*, and is clearly evidenced with the Cook *White Noise* record.

In some 5 weeks of use I found that it tracked even the most critical records without a single instance of skip or skating despite the low pressure of 3 grams—which incidentally is obtained in the production models and is not

simply a claim of what can be attained in the laboratory. The arm (see photo) departs from conventions markedly. It appears to be excellent from electrical and mechanical points of view. Arm resonance is said to be 3 cycles. I could find no evidence of it on the low-frequency sweep band of the Cook series 10, or the low-frequency band of the *White Noise* record; but on the innermost band of the Dabbings D-100 record, there was a trace of it to the touch. This low resonance is rather surprising because the arm is formed of tubular light metal, and implies a very clever and careful design.

The needle chatter is at least as low as any I have come across so far, and is, in fact, normally audible only a foot or two from the pickup. The element is a low-impedance device and despite its extremely low output is, I was surprised to discover, little if any more susceptible to hum than the G-E. A transformer is necessary to couple it to an amplifier. The Ferranti transformer supplied with it is compact, triple-shielded and easily positioned for minimum hum. With the D & R turntable the hum is inaudible at all home-listening levels. With the Ferranti transformer it will deliver around 15 mv on 78-r.p.m. records and about 8 on LP's—or roughly 3-5 db less than a G-E high-impedance cartridge.

The pickup (with the transformer) works into a 100,000-ohm load and when this load is provided it will be equalized

for all recording curves by any of the equalizers designed for magnetic pickups. (This includes the Golden Ear preamplifier which uses a feedback equalizer directly to the input.)

Two plug-in heads with diamond styli are available—one for the 78 r.p.m. and 33 r.p.m. transcription grooves, the other for microgrooves. The standard needle presents a revolutionary shape—an elliptical cross section 2.5 mils wide on the axis perpendicular to the grooves, but only some 0.6 mil wide on the axis of the groove. This is intended to correct for the great difficulty of 78-r.p.m. recording, namely: that a 2.5- or 3-mil stylus is larger than the sharp movements produced by the chisel-shaped cutting needle at frequencies higher than 10,000 cycles.

Ferranti says that the 78-r.p.m. head with this needle will track with very low distortion frequencies up to 20,000 cycles on the innermost groove of a 78-r.p.m. record. It tracked the Cook series 10 record to 20,000 cycles very nicely. It is rather amazing what this reveals on some of the best of the 78-r.p.m. records, particularly the Decca *ffrr's*; and I think indicated clearly that the old speed is capable of providing at least as good a high-frequency response on the outer grooves and a superior one on the inner grooves than 33-r.p.m. microgrooves. This might be an excellent head for those audiophiles who own large libraries of the older shellac recordings. It seems to produce as good a sound from many of them as that of the better LP's; and while the noise level is higher of course, the very flat response and the light pressure (5 grams at 78 r.p.m.) minimizes it.

A very nice little detail is the white dot on top of each cartridge which marks the position of the needle and makes the placement of the pickup easy. Indeed, what with this, the smallness of the head, and the well proportioned fingerlift, I personally found the Ferranti to be the easiest pickup to position exactly on a record I have so far used. However, I must report that men with larger hands, accustomed to handling

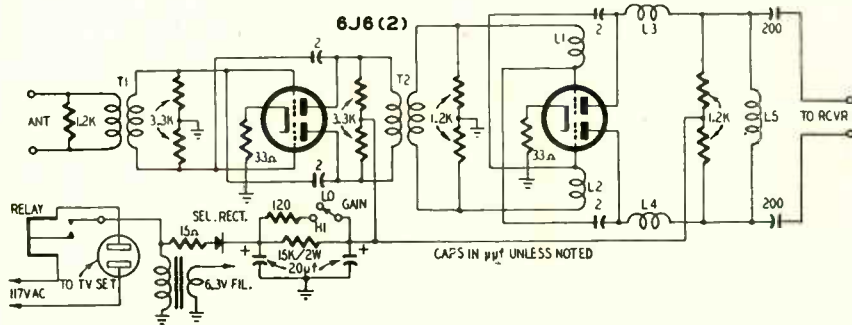

Fig. 1—Schematic of the Electro-Voice 3005FM booster—a wide-band amplifier.

AUDIO—HIGH FIDELITY



The Ferranti high-fidelity pickup.

much larger and heavier pickups, have been bothered by the smallness and extreme lightness of the Ferranti—it does take some getting-used-to.

The pickup requires a large hole (a little over an inch and three-eighths) for mounting but the method of mounting and the mechanical design produce an exceptionally stable, exact, and very neat mounting. At first glance the tracking angle seems all wrong. However, the element is mounted at an angle of 23° to the axis of the arm, so that, despite the straight arm, the tracking angle is very exact. This oddity, incidentally, almost eliminates the possibility of using the Ferranti cartridge in other arms—in case you've been thinking of that. It might be possible to find some means of adapting the mount, but either it would have to be mounted at a "reverse" offset of around 23° or the whole arm would have to be repositioned.

I doubt that it would yield the highest quality in another arm anyhow since the cartridge and arm were obviously designed to form a well-integrated unit, in which arm and cartridge complement each other. There is a built-in rest—when the arm is moved all the way to the right and placed down, it falls into a built-in, but invisible, notch which holds it firmly in place. The arm, however, will mount properly only on a base which provides at least $2\frac{1}{2}$ inches of clearance between the edge of the turntable and the edge of the mounting board. If the spacing is less, the arm will overhang the edge of the board in the resting position.

Whether or not the Ferranti lives up to its advertised slogan—"the ultimate in record reproduction"—I am not qualified to say. But since I have not heard better quality on LP's and on 78-r.p.m. records, it is pretty much in a class by itself. The highs on both speeds are very clean and the definition throughout the whole range is exceptional. I think it represents a notable step on the way to complete fidelity of record reproduction. It has only one fault from my point of view and that is the price of around \$75 for arm, transformer, and a single head (although, that doesn't compare unfavorably with the cost of an independent "professional" arm plus a diamond-stylus cartridge of other

Electro-Voice booster—has 300-ohm input.



makes). Those who can afford it will find the Ferranti capable of delivering very realistic reproduction with the best amplifiers and speakers available today.

Electro-Voice 3005FM Booster

If the descriptions of some of the new, highly sensitive tuners have made your mouth water, but an examination of the budget has brought tears of frustration to your eyes, all is not lost. The Electro-Voice 3005FM fixed-tune booster (Fig. 1) may well bring up the usable sensitivity of your old tuner to that of the newer ones and at an outlay of only around \$30.

This booster surprised me. I had had no doubts that it would deliver the 20 db of gain claimed for it, since it has two cascaded stages of amplification. But since it employs push-pull triodes (whose noise figure is considered to be inferior to that of a cascode stage) and is a wide-band job, I did not expect it to have usable sensitivity approaching that of a good tunable cascode booster. But it appears to have exactly that; certainly the sensitivity is high enough and the noise figure good enough to dig right into the antenna and atmospheric noise. It actually did a better job than my home-built tunable cascode booster which I had proudly considered to have a very good noise figure.

The figure of 20-db gain is conservative; the model I tested clearly had more than that. It is uniformly distributed over the whole FM band—there seem to be no hot spots and no cold spots. It turned out to be completely stable even with the rather critically "hot" front-end of my receiver, and apparently uncritical about the length of cable used between it and the receiver. Both the input and output are for 300-ohm twin-leads; but it worked very well into the unbalanced input of my set, without a matching transformer.

No tuning is required, of course. A thermal switch turns it on and off with the receiver. It is very compact—about $4 \times 6 \times 5\frac{1}{2}$ inches—and can be tucked away in any odd corner of a cabinet or bookshelf; and drawing only about 12 watts of power at normal line voltages, it runs very cool.

There is a switch to reduce the sensitivity by lowering the applied plate voltage—a good idea since the tuned circuits and the antenna match are not disturbed as they are in boosters which switch the antenna leads from booster to receiver. In most locations in which a booster is necessary at all, the switch can be left permanently in the HI position.

Assuming you have a tuner with a sensitivity of between 15 and 25 microvolts, which is a pretty good average for the better old tuners, and the less expensive new ones, this booster will bring up the usable sensitivity to a point comparable with that of the best new receivers. Moreover, in very difficult locations it is possible that it may improve reception even with the new tuners just enough to make the difference between *hearing* a station and enjoying high-fidelity, noise-free reception of it. This is a long overdue gadget which should prove very useful under several types of conditions.

The New Records

To avoid confusion, let me define my idea of test, demonstration, and show-off records. A test record is one that offers a good means of testing distortion, intermodulation, transient response, definition, naturalness, presence, etc. A demonstration record is one that makes a system sound good—especially to the prospective customer. Thus a good test record will probably serve best to demonstrate a system to an engineer or skilled listener; but the typi-

cal test record used at audio fairs is likely to send the ordinary layman or music-lover back to his table-model radio. For demonstration records I look for a smooth high end, and a nice bass, an unusual degree of that something vague called "presence," or any quality that would reveal to an average ear the superiority of a good high-fidelity system over the ordinary record player or radio. A show-off record is one that gives a more or less spectacular effect, or stunning sound—the kind the proud audiophile can use to show his friends and neighbors why he wasn't nuts in spending all that money on a hi-fi outfit. I am not so interested in pointing out records suitable for use by manufacturers at audio fairs; they have their own means and ideas. I am more concerned with giving the small dealer, distributor, installer, and the audiophile, some idea of the suitability of the new records for their particular needs and purposes; and to point out any interesting "sound" (rather than musical) quality I may discern in the new records. Finally, I want to record the new developments in recording techniques and the progress on the road to that utopia—reproduction indistinguishable from the production.

Equipment makes a difference and where it makes a marked difference I will point it out. But I review each record through a variety of equipment representing every high-fidelity category from the low-priced to the cost-is-no-object grade. The reference system for absolute quality uses a D & R turntable, a Ferranti pickup, a 30-watt amplifier of my own design, and a wall-mounted array of five speakers, including two 15-inch woofers.

MUSICAL SOUND BOOKS

SAINT SAENS: *Carnival of*

Animals MSB 78010-12 (3 records)

SAINT SAENS: *Phaeton* MSB 78201

AMERICAN MUSIC: *Juba Dance,*

Turkey in the Straw, Cheyenne

War Dance, Gossips MSB 78024

All performed by the Philharmonic Orchestra of Hamburg

(\$1.25 per disc, plus 50c packing and handling on orders less than 10 discs. Sound Book Press Society, Inc., Scarsdale, N. Y.)

I love to explore the byways, and once in a while such exploration pays off interestingly. In July I reviewed the remarkable *Plectra and Percussion Dances* by Partsch. This month I report another worth-while find.

The Musical Sound Books comprise a new library of recorded music for use in music appreciation classes in elementary and high schools, and represent a noteworthy experiment in recording technique. The original recordings were made in Europe on 30-inch-per-second tape with a response from 20 to 20,000 cycles. These were transferred here to 78-r.p.m. discs using somewhat closer groove spacing and variable pitch for extended play and to take care of dynamic range; they

were cut with the hot stylus to the NARTB standards and curves.

At present the Musical Sound Books library consists of 51 10-inch records. By the use of extended-play techniques some of these discs run 5 minutes to a side. The catalog, though chosen for the musical education of children, is musically excellent and only the most sophisticated listener would be bored by it.

Carnival of Animals has always been excellent for test purposes, and this one is especially good. Above all, I think that MSB 78010 would find a worthy place in almost any show, sales, or demonstration room and the libraries of most proud audiophiles. The reason is the 2nd band on side B—*Elephants*, played here with a double bass as it should be. When have you last heard a double bass on records? I don't mean the slapped bass of popular records, or the usually boomy noodling of the double-bass section of a symphony; I mean close-up, bowed rather than slapped, growling so you can almost count the cycles? If your amplifier and speaker system can do justice to a double bass, this record will put a supremely happy smile on your face.

Aquarium on 78011 provides some lovely, clean, and unartificial highs! The neighing strings in *Long Eared Persons* are excellent for distortion testing, particularly because they are on the innermost bands—any pickup or system-distortion will throw them into painful fuzziness. *Fossils* on 78012 has always been good material for transient testing and this version has an extremely dry (as opposed to mellow) xylophone. Even that old chestnut *The Swan* is useful here, for the rather reedy character of the upper register of the cello, as contrasted with the mellowness of its mid and low range, comes through very nicely. The fact is, this inexpensive set of three is an excellent test set. And it provides a dividend: you can be pretty sure the rest of the family won't find these as unpleasant as the more spectacular test records.

Phaeton is a much more obscure piece of music but it is of hi-fi interest because of the various choir effects of massed brasses, strings, and winds, beginning with the opening fanfare of several beautifully matched horns. If system-definition is good enough you can almost count the horns. There is also a very unusual string background, the fiddles very high and stroked (*spiccato*) rather than bowed. The bouncing of the bows produces a high proportion of harmonics around 9 or 10 kc. The result is a very individual sound, and if you raise the treble a bit [or move the equalizer from NARTB to ORTHO (new RIAA standard) or old AES] you can almost hear the rosin.

The recording containing the four pieces by American composers is a good show-off record. There is a little distortion in the peaks, but it isn't bad except when compared with records such as the Cook *Masterpieces of the*

Theatre. There is a good mixture of highs and lows, legatos and various percussives including good drums; the balance is splendid, to my taste, as it is on all this series. The resulting sound is very pleasant on almost any system. I have always liked plucked or *pizzicato* strings for transient testing and *Gossip* on side B is very good for this purpose, particularly since the whole range from a reasonably deep bass to a fairly good high is covered.

It strikes me that a stack of these records would be ideally suited for the small commercial hi-fi sales or demonstration room, although the material is not spectacular enough for audio fairs. First, the pieces are very short and, if you use a single-play turntable, will enable you to put in a good selling pitch between records. Second, these 78's are less susceptible to damage, will stand more playing, and should give good quality for a longer period. Third, at \$1.25 per record, accidents and wear and tear will be easier on the budget. Fourth, the music is uniformly pleasant and few people are likely to be allergic to any of it. Fifth, they produce excellent sound with high-fidelity systems.

The recording curve is NARTB but they play back all right with the LP curve. With a spherical needle you might try, if your equalizer permits it, the NARTB or NAB bass and an RIAA (ORTHO) or even old AES treble; or boost the high-highs a little with the tone control, to make up for needle translation losses.

MUSIC APPRECIATION RECORDS BY CAPITOL

Chin-Chow and the Golden Bird. (Music from the "Nutcracker Suite")

CAS 3193

El Torito the Little Bull. (Music from "Carmen")

CAS 3194

The Seasons (Music from Glazuno's "The Seasons")

CAS 3195

These are intended for use in the home with pre-school and slightly older children and I mention them because you may have seen and been intrigued by the ads. They may do the intended job; but in case you've wondered, they have no hi-fi value whatever. This is a shame because the music is from the excellent tapes in Capitol's classic library and at 99c apiece they would offer a very useful set of records for demonstration purposes. Unfortunately, the voice completely kills the music. It is recorded at a level some 12 db above the orchestral peaks, and it covers so large a portion of the record that the music is audible only as interference is audible behind a desired radio program. Personally, I question that these will have much musical effect on children, because of this submergence of the music; but in any case, it makes these records completely useless to the hi-fi tribe—even the voice is poor, obviously pre-emphasized for the cheap players used by children. If Capitol would put out the same things without the voice, they might well cause a stampede. END

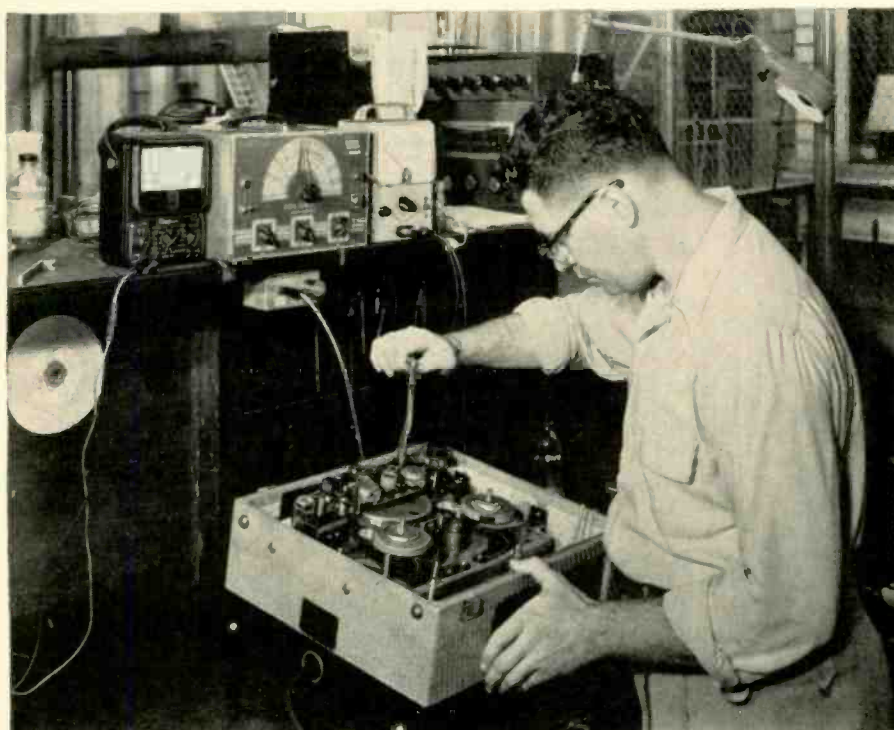

A service technician using special bending tool to set critical mechanical clearance.

A few experiences on the bench, showing that recorders have their quirks but are not difficult to service

Photos Authorized Factory Service, New York, N.Y.

TAPE RECORDER SERVICING—

TAPE recorders being popular, your chance to service one of them will come; and when it does, it may be a hurry job. The novelty of a device can stump you for a while, but your knowledge of high-gain amplifiers plus advance information of this sort should enable you to give prompt attention to a tape recorder.

Tape recorders may have two kinds of trouble—mechanical or electrical. The mechanical troubles are simpler, but usually give the technician more agony, simply because they are likely to be new to him.

Depending on the nature of the trouble, you may not need to go straight at the wiring. Get acquainted with the recorder topside first. Remove the guards and carefully examine the recording head and the tape way. The head, against which the tape is pressed by a felt pad in both the record and play motion, should be perfectly clean and smooth. Any roughness will scrape the tape and collect a reddish deposit. If found, this deposit must be cleaned off with soft wood stick, brush, or soft cloth wrapped around an alignment tool.

The felt pad itself must be soft, clean, free from any hard particles imbedded in it, and free to move on its post under the tension of its spring. A worn, hard pad will cause distortion and excessive scraping of the tape.

For all other attention the chassis

mechanism must be taken out of the case. Pull the plug! Don't be in a hurry to turn on the power. Make your safety checks first. Remove the most convenient tube, either power or rectifier, discharge the capacitors, and touch one prod of your ohmmeter to the chassis and the other to the pin in the socket that will give you the screen supply line. The needle should kick down and quickly rise to about 50,000 ohms. Any wide deviation from this value indicates trouble. Here is an example:

A resistance check showed 5,000 ohms from screen supply to chassis. This indicated a short. The bottom cover was then removed and the circuit was inspected. The filter resistor was dark due to overheating. The d.c. line had three branches: power, screen, and first stage. Since the first stage must have a decoupler, the capacitor for this was located and the lead to it was opened. Two touches of the prod showed the first stage perfect. In two more steps the leaky bypass capacitor at the driver-tube screen was found.

Once all resistance measurements were normal, the power was turned on and voltage readings were taken. There was no screen voltage on one of the first-stage tubes. Checking showed the loss was in the lead itself. Ohmmeter reading across the ends of the lead showed infinite resistance. At the screen pin the joint was dark and

coarse. Reheating it solved the trouble.

By far the most frequent complaint in my experience has been noise. A recorder was rushed to me from a parish house. The machine was but three weeks old, still new to the users. The complaint was noise. The noise was a rumble, resembling motor-boating. It could be heard in play, record and rewind settings, and with the volume control down. The conclusion pointed to mechanical and not circuit trouble.

Unplugged, the chassis was taken out of the case and the mechanism was turned slowly by hand. Every part was carefully examined. Chewed into the rim of the rubber driver was a fresh nick like those we find on record players when the tire rests too long in one spot against the motor shaft.

Obviously, to remove the nick, the driver had to be dressed down. Inspection of the arrangement showed that after the resurfacing there would be enough rubber left to drive the mechanism. A medium-cut file was used and the job was successful. But bear this in mind when filing moving work. A rubber tire, especially, will yank the file out of your hands and may damage some parts. Grasp the file firmly and rest it first on a fixed member of the frame to assure an even cut.

Another caution. Rubber particles or dust falling on a tube will cause an objectionable smell when the tube gets

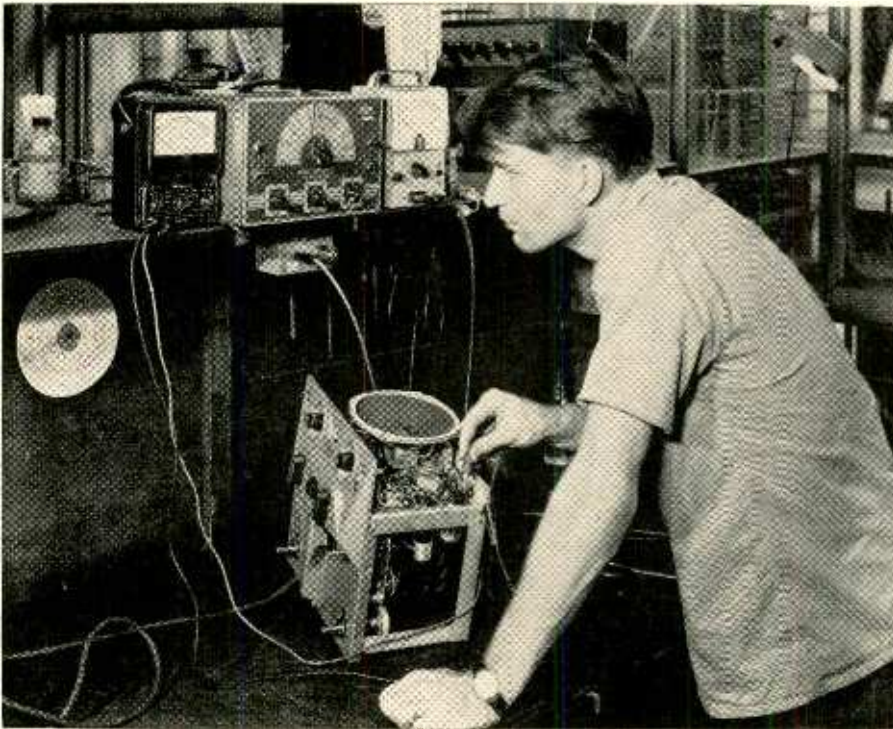

A recorder's electronic circuits are checked with standard equipment used for audio and radio.

By MICHAEL SMOLLIN

hot. Always brush out the interior well and be sure the tubes are clean.

A doctor brought his recorder for service, saying it was haywire. After preliminary checks the power was turned on and the selector set to play. I was greeted by a noise like that of a junior high school band warming up. That was a tough one. Routine measurements proved nothing. The multi-frequency noise indicated a sparking. It could not be squelched or isolated. Sometimes under shock, the offending part reveals itself. Every part was tapped sharply with a fiber tuning tool. When a mica capacitor was thus struck, the noise varied. All other parts were disconnected from it and it was left alone on the tie strip. With the capacitor analyzer connected across it, the magic eye quivered, indicating the spark was in the mica capacitor.

There was a case similar to this, but when I turned the power on, the machine worked perfectly. This showed that the trouble was intermittent. While running, the mechanism was set on each of the four sides to see if the weight-shift made any difference. As this was negative, the fiber tuning tool again went to work. When the main filter capacitor can was tapped from all sides, the trouble returned. It was a twist-prong affair that sometimes worked loose. A stiff lead was soldered between the can and a socket ground lug.

When the trouble is traced to a volume control that is concentric with a tone control, be careful when taking it apart. Some parts will spring out unless you expect this. Note which side of each part goes in first.

The oscillator may never need attention in the field. However, do not drive the brass screw down just for curiosity, since the inside metal slug will touch the high-voltage lugs and the coil will burn.

Microphonic, and especially, gassy tubes are another thing to watch for. Try new tubes. Try several. Echoes of previous recordings may cause double-talk in reproduction. The overload lamp must not flash bright in recording; reduce the volume so that only a faint flicker occurs. The mike should be away from the recorder by at least the length of its cable, and on a separate table to prevent vibration from reaching it.

For a final check see that the machine runs quietly, for any audible noise will be picked up and recorded. If the machine is noisy, check the motor fan on the lower end of the shaft. Rub some vaseline onto the spacer metal and felt washers. Don't use any oil. If you remove the fan, be sure to run a straightedge across chassis bottom after replacing, to make sure everything will clear the cover when it is attached. END

NEW LOCKOUT CIRCUIT

In broadcasting and recording studios, PA announcers' booths and similar installations, all monitor and intercom speakers must be silenced (locked out) when the mike is live to prevent picking up unwanted sounds. The usual procedure is to use a switch or relays to open one circuit as the other is closed. In large intercom systems a similar setup, activated by the talk-listen switch, eliminates feedback between speaker and microphone on the same unit.

The diagram shows a relay-less electronic lock-out circuit that appeared in *NYU Quadrangle* (College of Engineering, New York University). In this application it eliminates switching in intercoms. The stage including V1 is inserted in the intercom master between the microphone preamplifier and the power amplifier. The remote station is driven by V1. a transformer in the cathode of V1.

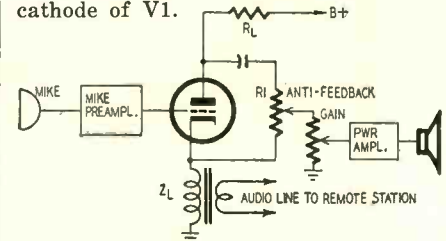

When viewed from the power amplifier, V1 appears as a split-load phase inverter developing 180° out-of-phase voltages across R_L and Z_L (the impedance of the transformer) in the cathode circuit. The arm of R_1 may be adjusted so the voltages cancel and are not passed on to the power amplifier.

Viewed from the microphone, V1 appears as a cathode follower transformer coupled to the remote station line.

Signals originating at the remote station and arriving on the audio line are transformer-coupled to the input of the power amplifier. Incoming signals, not amplified by V1, do not cancel.

MAGNET STRENGTH

The permanent magnet manufacturer makes many of his magnets to an exact specification. They are calibrated to a specified flux density. Special care is taken with meter magnets, which are treated to assure that their strength will remain constant for many years.

In many applications—such as speaker magnets—where great magnetic strength instead of exact calibration is important, the magnets can be magnetized after assembly into the unit. The magnetic field produced in the gap of a permanent-magnet loudspeaker, for example, with an Alnico V magnet magnetized *after assembly* is about three times as great as the field when the magnet is magnetized before.

Service technicians will see that such an assembly should never be taken apart—in the cases where disassembly is possible. The magnet will immediately lose most of its strength.

SERVICING

HIGH-FIDELITY

EQUIPMENT

*Part VII—Checking the phonograph
needle: its condition and alignment*

By JOSEPH MARSHALL

THE phono pickup has more opportunities to ruin the performance of a high-fidelity system than any of its other components. Yet few audiophiles—and not all service technicians—know how to diagnose and repair phono troubles. As a result, many fine systems are limping along at only a fraction of their possible performance.

All needles—even diamonds—wear with use and need replacement to prevent record wear and damage. But how do you know when to replace a needle? It would be nice if we had some categorical answer like “20 hours for a sapphire and 100 hours for a diamond.” But there is no such simple rule, nor ever can there be. The only way to tell if a needle needs changing is to check it often. Fortunately, we have several methods which—together or separately—can determine needle condition very accurately.

Visual inspection

The oldest method is to look at the needle through a magnifying glass or microscope. This is not as simple as it sounds—you have the problems of applying enough light and of getting a sharp focus at all angles. Also, assessing the damage requires skill and experience. True, if flats are visible or the needle is chipped, one can safely conclude that it is dangerous. But—on LP records especially—it takes a good hand and eye to recognize minor flaws that can cause high distortion and severe record wear. The needle or pickup must be turned and the light moved to hit it from various directions. A perfect needle has a uniform appearance and reflects lights uniformly on all sides; a needle with flats will reflect more light from the sides containing the flats.

Needles accumulate dust and grime—often enough to hide serious damage. Before examining them, brush them first with a fairly stiff dry brush, then with a softer brush dipped in cleaner fluid, to remove the film and expose the surface of the jewel.

We have substitutes for visual inspection which are often more effective in diagnosing early damage. An old technique, and still a good one, is to use a soft lacquer recording disc, part of it with unmodulated grooves. First place the needle on the portion without grooves, (a quarter can be placed on the cartridge to weight it down a little); and keep the pickup from skating clear off with a light pressure of the finger on the inside to guide it in a spiral. The surface is then inspected. A good 78-r.p.m. needle will leave almost no sign; microgroove needles may leave a just visible mark, but they should not dig a definite groove. Scratches or grooves beyond this indicate that the needle is cracked or chipped at the point.

For checking flats on the side the needle is allowed to run in the unmodulated groove. Then examine the groove with a glass and cross-lighting. The cutting needle leaves a very distinctive pattern which is uniform and constant; when a needle with sharp edges is run through it, this pattern is changed. Comparison of the grooves through which the playback needle ran with those through which it didn't run will indicate the extent of the damage. This procedure, too, takes some experience and skill.

But a needle can be good enough to cause no visible damage to a record long after the distortion it contributes is intolerable for true high fidelity. Up to a couple of years ago, the total distortion of record reproduction was very high, since it included the distortion recorded on the disc, plus that caused by aging and distortion of the disc, the portion produced by needle and pickup, and finally turntable hum, wow, rumble, or flutter. Recorded distortion is today only a fraction of what it formerly was. Cartridges and pickups have been greatly improved, and engineers have been hounding the hum and rumble of turntables until in a few cases it has been reduced to so low a level that it can be disregarded. So now needle distortion accounts for much more of the over-all

distortion than ever before—indeed it may be the dominant portion.

The Cook Series 10 test records are one of the earliest and still one of the most effective applications of needle distortion measurements. This method is to measure the translation loss of a needle at high frequencies. Here is how it works: You make a note of the pickup's output level at 10,000 cycles on the outer band of band A of side 1, then move it to the innermost band of the same side, which contains a sequence of 1,000- and 10,000-cycle tones. After readjusting gain so that the output at 1,000 cycles is the same as that of the 1,000-cycle band at the start of the record, you note the reading for the 10,000-cycle tone. The normal translation loss at 33 r.p.m. is a little over 6 db. So if the needle on the innermost 10,000-cycle groove gives a reading of between one-third and one-half of that on the outer 10,000-cycle band, the needle is fair to good; but if the reading is only one-fourth as much, or less, the needle is poor. This is a very sensitive method and will spot needles no longer capable of giving high-fidelity performance even when other methods pass them.

Distortion tests can be made with the Clarkstan Intermodulation records, or the IM bands of the Cook Series 10, plus an intermodulation analyzer. The Clarkstan record is the more sensitive indicator because it covers the whole

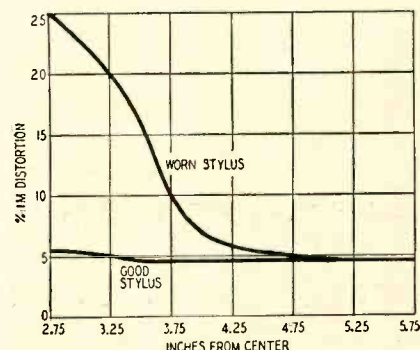

Fig. 1—IM rise due to worn stylus.

HIGH-QUALITY AUDIO

by RICHARD H. DORF*

*Part XIII—The power amplifier;
tubes, single-ended and push-pull stages*

POWER-amplifier stages are no more difficult to understand than voltage-amplifier stages, but because the job they do is more difficult more careful design is required for high-quality results. A voltage amplifier produces a higher audio voltage at its output than at its input. The actual power at either point is of little interest because the following grid is excited by *voltage* changes.

A power amplifier, on the other hand, must furnish power to the loudspeaker, a unit required to do actual work—pushing air. Electrical power consists of current passing through an impedance. If current passes through a simple resistor, work is done in heating the resistor and the air around it. If current is passed through a solenoid coil with a movable core, the core is moved, and that is work. If it is passed through a loudspeaker voice coil, the voice coil is moved. The fact that a speaker cone is attached to the voice coil and that cone movement is opposed by air adds to the amount of work to be done.

The amount of mechanical energy required always depends on the resistance of the load—its weight, the forces resisting its movement, etc.—and the speed with which it is to be moved. You can push a dresser across the bedroom in perhaps 30 seconds, but more strength—power—than your body commands would be necessary to do the same job in 1 second.

A loudspeaker cone moves far but slowly at low frequencies and fast but not far at high frequencies. The amount of mechanical power required for equal sound output at all frequencies is thus the same. The same is true for the electrical power which is transformed by the speaker into mechanical power—at

least over the range of frequencies for which the transforming action is linear. This depends on speaker quality.

Electrical power is the product of the square of the current and the impedance of the load through which it is passing— $P=I^2R$. Since current cannot flow through an impedance unless there is voltage across the impedance, voltage is definitely related to power. By substituting E/I for R , we get the simplified power formula $P=IE$ or current times voltage.

The original equation $P=I^2R$ shows that to have high power, either current or impedance (or both) must be high. A speaker voice coil is usually a low impedance, perhaps 4 to a maximum of 16 ohms. If we want an amplifier capable of putting say, 8 watts into a 4-ohm speaker, let us see what current is necessary. Rearranging the formula,

$$I = \sqrt{\frac{P}{R}} = \sqrt{\frac{8}{4}} = 1.41 \text{ amperes,}$$

obviously more current than we can expect any reasonable receiving type tube to pass.

The solution is to use an output transformer to present a much higher impedance to the output tube (Fig. 1). The transformer has a turns ratio of 40 to 1. Its impedance ratio is therefore the square of that or 1,600 to 1, and its primary impedance is 6,400 ohms. The primary current is reduced by the turns ratio and becomes only 35 ma, a very reasonable plate current. This solution to the problem is almost always used; primary impedances run between about 2,500 and 15,000 ohms.

Power tubes

There is no basic difference of principle between voltage- and power-amplifier tubes, and each type can be used for the other's purpose. However, tubes built for power have more rugged elements, so they can dissipate the greater heat caused by the higher power dissipation, and the amplification factor and plate resistance are lower because of the close spacing between elements necessary for high plate current.

The simplest type of power amplifier (Fig. 2) works on exactly the same principle as a voltage amplifier. There are the same tube elements—grid, cathode, and plate—the same input circuit, and the same cathode-bias arrangement. The plate is loaded in the same way, by an impedance between B plus and the plate. Output is obtained as usual by plate-current variations passing through the load. There is only one difference: instead of connecting the voice-coil lead to the plate, we take output from the secondary of the transformer—and even this is not a real difference, since some voltage amplifiers in broadcast and commercial work have transformer-coupled voltage stages. The real differences cannot be seen in Fig. 2—that is, the different tube type, the lower load impedance, and the higher tube plate current.

There is one other point: In all choke- or transformer-coupled amplifiers, gain and power are higher than in resistance coupling for the same a.c. load value because the d.c. resistance of an inductor or transformer is comparatively low and almost the full B voltage is applied to the plate.

Tubes of several types are used in power amplifiers. There are triodes such as the old 2A3 (now obsolete), 6A3, and 6B4. Pentodes are used, such as the 6F6 and 6K6. And there are beam tubes like the 6V6, 6L6, 807, and variations of them. Triodes can pass more current than the others and thus require smaller turns-ratio output transformers (or can use higher turns ratios and give better speaker damping). However, they do not amplify very much and earlier amplifier stages must present high audio driving voltages to their grids. Beam tubes require much less driving voltage, and thus a lower-gain voltage-amplifier section can be used in the system. But since they can pass less plate current, output transformer primary impedance must be higher. The difference turns into a question of economy vs. quality. The beam tube permits economy in preceding stages, while the triode permits

more current than the others and thus require smaller turns-ratio output transformers (or can use higher turns ratios and give better speaker damping). However, they do not amplify very much and earlier amplifier stages must present high audio driving voltages to their grids. Beam tubes require much less driving voltage, and thus a lower-gain voltage-amplifier section can be used in the system. But since they can pass less plate current, output transformer primary impedance must be higher. The difference turns into a question of economy vs. quality. The beam tube permits economy in preceding stages, while the triode permits

*Audio Consultant, New York

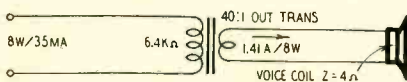

Fig. 1—Output-transformer circuit.

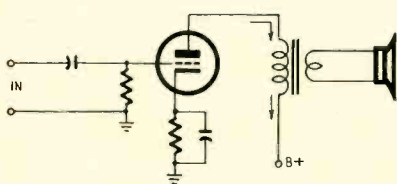

Fig. 2—A simple power amplifier.

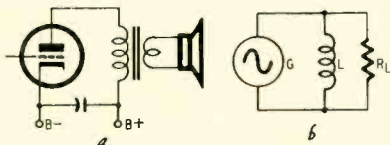

Fig. 3—Actual and equivalent circuit.

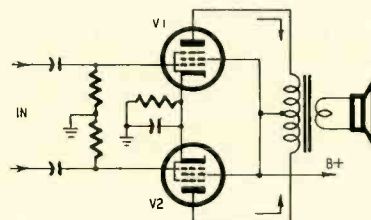

Fig. 4—A push-pull output amplifier.

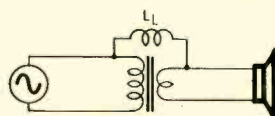

Fig. 5—Equivalent leakage inductance.



The Brociner UL-1. Large output transformer provides enough primary inductance.

better speaker damping and more stable feedback circuits.

Why push-pull?

The single-ended stage of Fig. 2 is never used for high-quality work. It would not yield sufficient power output for even a modest home music system, and, more important, both frequency and waveform distortion can be drastically reduced by using a push-pull stage.

Frequency distortion in a single-ended stage takes place principally in the bass because of the output transformer. Fig. 2 shows that there is a d.c. flow through the transformer at all times in one direction, from plate to power supply. As in any inductor with an iron core, this unidirectional d.c. tends to saturate the core and reduce the inductance of the transformer. With the total transformer primary inductance reduced, the frequency at which the primary inductance is equal to nominal primary impedance rises; and at this frequency the response is down 3 db.

Fig. 3 shows how this works. At *a* is the actual output transformer circuit. The output impedance of any tube in this sort of circuit determines the output voltage. At *b* is the approximate equivalent circuit. The tube is represented by the a.c. generator, the transformer primary inductance by L , and the load resistance is reflected back to the primary, by R_L . L and R_L are in parallel, and R_L is fixed by the speaker voice-coil impedance and the transformer turns ratio. (For example, the 6,400 ohms shown in Fig. 1 would be R_L .) Assuming the speaker itself remains constant with frequency, L begins to short-circuit R_L as the frequency becomes lower. Where they are both equal, plate current has an equal effect on each. However, only the current acting on R_L actually drives the speaker, so the speaker power is reduced by one-half. Naturally at lower and lower frequencies, the shunting effect of L becomes still greater, and less current acts to drive the speaker.

This is why a 35-cent output transformer can have "correct" impedance

characteristics but cannot possibly reproduce good bass.

It also shows why a single-ended output stage, in allowing unidirectional d.c. to flow through the primary of the transformer, reduces the primary inductance and thus the low-frequency response.

Fig. 4 shows how a push-pull stage gets around this difficulty. Plate current flows from the upper tube to the center-tap and power supply. It also flows from the lower tube to the center-tap and power supply. The two equal currents (d.c.) are opposite in direction of flow (assuming the circuit and transformer are properly balanced). As a result, they cancel and have no tendency to saturate the core and reduce inductance. It is of course true that even with a push-pull circuit a 35-cent transformer will not have good bass characteristics because it is simply too small, without enough iron to have high inductance. However, the same size transformer will perform a great deal better in a push-pull circuit.

Before leaving transformers, it is a good idea to examine another important characteristic limiting their frequency response. This is leakage inductance, which is inductance between the primary and secondary (Fig. 5).

If primary-to-secondary coupling were perfect (unity), the energy in the primary would be transferred to the secondary with the same efficiency at all frequencies. With less than perfect coupling there is inductive transfer between windings. The inductance involved is relatively small, and at low frequencies its reactance is negligible and coupling of energy is very good. But at some treble frequency the reactance of leakage inductance L_l becomes equal to the impedance of the voice coil. And then the circuit is that of a low-pass filter, with L_l as the series leg, rising in impedance with rising frequency, and the speaker as the shunt leg, remaining constant (ideally). At this frequency of equal impedances, response is down 3 db and falls off rapidly thereafter. In addition, phase shifts that are produced limit the amount of negative

feedback which can be used without instability. Selection of an output transformer with high primary inductance and low leakage is therefore a highly important factor.

The harmonic-distortion reducing capabilities of the push-pull stage as well as its inherent hum reduction depend on phase relations which are very simple to show. Let us refer to Fig. 4 and assume that a sine-wave signal is applied to the grids from a phase splitter. The grid of V1 will be driven positive and V2 negative. At this instant, then, the V1 plate will become less and the V2 plate more positive. Since there are opposite polarities at the ends of the transformer primary and audio current therefore flows through it driving the speaker, the push-pull stage is functioning normally.

Now suppose that the phase of the V2 signal is reversed. Now both grids will be positive, both plates less positive and the two ends of the transformer primary will be the same potential. No audio current will flow through the transformer and thus no output. We may thus take it as a rule that there is output when any signal applied to the tubes is applied out of phase and no output when the same signal is applied to both tubes.

Let us look at how hum is affected. Hum may arise because the power supply is insufficiently filtered. This hum is applied to the tubes as 120-cycle variations in the B-supply. It is applied directly to both plates through the output transformer. Since it is in phase at the two plates it cancels and produces no output. Hum may enter also through the filament supply or a screen supply if there is one; in each case it is applied equally to the two tubes and produces no output.

Now for distortion. One type of distortion is caused by too small a negative grid bias, so that the peak of the grid wave draws grid current and causes a clipped or flat-top plate wave. As a result, the output of each tube has a negative flat top. But since one of the tubes goes negative each half-cycle of the input wave, one of them produces a negative flat top for each half-cycle. The combined output wave at the speaker is therefore flat at both top and bottom. This makes the wave symmetrical. Any symmetrical wave contains only odd harmonics, while an asymmetrical wave contains either evens only or both odds and evens. What we have just seen, therefore, is that while each tube had both odd and even harmonics added to the original sine wave because of the clipping, the resulting output has only odd harmonics.

The push-pull stage thus cancels even-harmonic distortion. It does not simply translate it to odd harmonics; the output wave from a push-pull amplifier will contain only those odd harmonics which were created by the clipping, and of course the total distortion is less than that produced by either tube.

(TO BE CONTINUED)

NEW TOOLS

Better test equipment for high-fidelity servicing

for the Audio Technician

By ROBERT F. SCOTT

TECHNICAL EDITOR

NOW that the public has really discovered high fidelity, the audio service technician must be prepared to service, test, and evaluate all types of amplifiers, record changers, preamplifiers, and equalizers. The multimeter and headphones used by the audio technician in the past have been replaced by audio v.t.v.m.'s and wave, distortion, and spectrum analyzers, and other specialized tools of the trade. The transition to high fidelity has been so rapid that many technicians—busy with TV and its problems—have found themselves with

taneous change in the pitch of frequency (frequency modulation) of the signal being recorded or reproduced. In phonograph equipment, wow is usually caused by a warped or off-center turntable, by a record with an off-center hole, or by flat or slick spots on the belt or rubber-tired drive wheel.

In magnetic tape and wire recorders the trouble is usually caused by misadjustment of the take-up and rewind drives, off-center or misadjusted capstan, or defective tape or reels. High background noise on tape or wire is caused by a trouble similar to that causing wow. The wire or tape begins to vibrate so it slaps the heads at a fairly high frequency. This results in frequency modulation of the signal being recorded or reproduced.

Defects in the mechanical system of recording and playback devices may also cause an interference, called rumble. It is heard as a fairly low-frequency background signal caused by vibration of the drive motor.

Wow, flutter, and rumble are usually measured in percent using either of these two formulas:

$$\% = \frac{S_{max} - S_{min}}{S_{ave}} \times 100$$

where S_{max} is the maximum speed, S_{min} is the minimum speed, and S_{ave} is the average speed when S is measured in r.p.m. or inches per second.

$$\% = \frac{F_{max} - F_{min}}{F_{ave}} \times 100$$

where F_{max} is the highest frequency

erator, test record, or test film, is usually in the range of 1,000 to 3,000 cycles. The modulating signal, appearing at the output of the discriminator, is in the range of 0 to 500 cycles. The amount of low-frequency signal is read on a meter calibrated in percentage of wow.

A simple wow and flutter meter

The D & R model FL-3A wow and flutter meter is a comparatively low-cost instrument designed to assist the audio service technician and engineer in measuring wow and flutter from phonograph turntables and wire, disc, and film transports. A block diagram of it is shown in Fig. 1 and the schematic in Fig. 2. The instrument uses a 3,000-cycle test signal from an audio signal generator. This signal is used to modulate test records to be played back on equipment being tested. The 3-kc tone may be supplied by a standard test record.

The signal from the equipment under test is fed to the wow meter at a level of at least 2 volts. At this level, the signal saturates the 6AU6 limiter and thus eliminates hum, high-order harmonics, IM products, and interference that amplitude-modulates the test signal.

The limiter characteristic is shown in Fig. 3-a. The output of the limiter feeds a 6AL5 modified Foster-Seeley discriminator tuned to 3 kc with linear output response for all signals between 0 and 200 cycles.

The limiter drives a 6C4 cathode follower with a low-pass filter in its

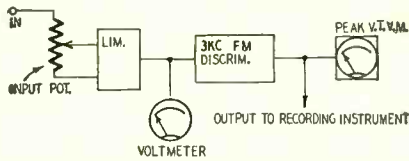

Fig. 1—Diagram of D & R model FL-3A.

old-fashioned and inadequate audio servicing techniques and equipment.

This article is one of a series to bring the technician up-to-date on modern audio servicing methods and equipment. This month we will describe circuitry and applications of two instruments that are important to the technician.

Wow and flutter

Periodic variations in the speed of phonograph turntables and wire, tape, and film transport mechanisms produce an annoying type of audio distortion commonly called wow, or flutter. This speed variation causes an instan-

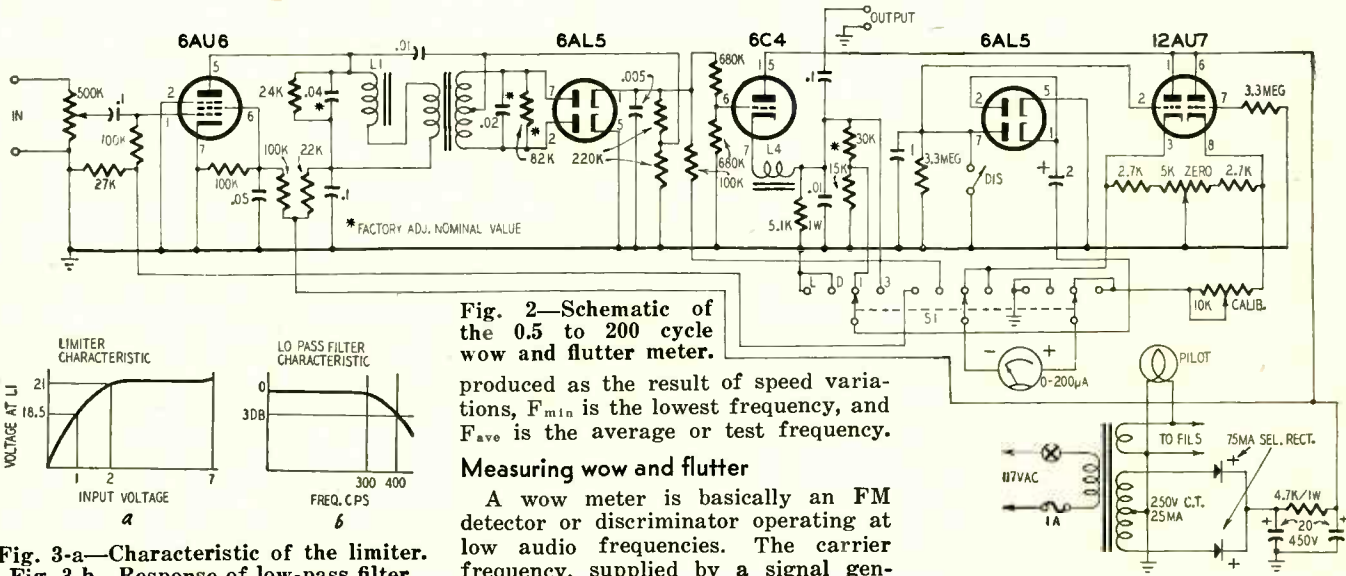

Fig. 2—Schematic of the 0.5 to 200 cycle wow and flutter meter.

produced as the result of speed variations, F_{min} is the lowest frequency, and F_{ave} is the average or test frequency.

Measuring wow and flutter

A wow meter is basically an FM detector or discriminator operating at low audio frequencies. The carrier frequency, supplied by a signal gen-

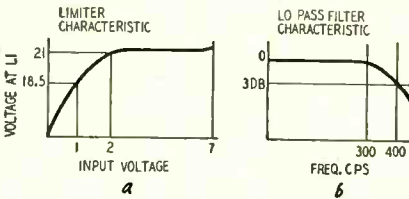
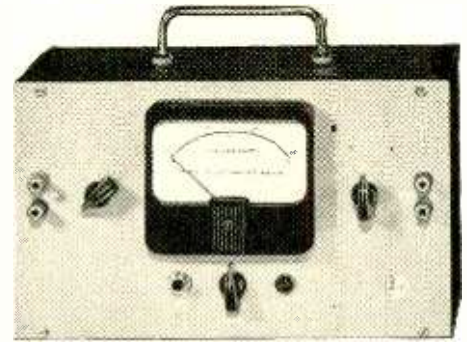

Fig. 3-a—Characteristic of the limiter. Fig. 3-b—Response of low-pass filter.



Heathkit intermodulation analyzer.



The FL-3A wow and flutter meter.

output circuit. The response of the filter is shown in Fig. 3-b. The cathode-follower output is fed simultaneously to an internal v.t.v.m. and to OUTPUT terminals for connecting a scope or a recording oscillograph. The v.t.v.m. is an a.c. type with a push-pull 6AL5 rectifier with a time-constant of 3.3 seconds. The filter and the time-constant combine to enable the meter to produce accurate indications of peak flutter and wow voltages in the range of 0.5 to 200 cycles.

The meter has two ranges: 0 to 1% and 0 to 3%. Accuracy is within 10%. The output to the recorder is 0 to 8 volts with a 1% peak-to-peak flutter from a 440,000-ohm source.

Function switch S1 is for setting the meter range and making adjustments necessary for proper operation of the instrument. Position L measures the input signal level with the 5,000-ohms-per-volt meter across a section of the limiter grid resistance. The input potentiometer is set so the meter reads 0.4% on the 3% scale. This assures the correct level of the input signal.

Throwing the switch to D places the meter across the discriminator output and permits the test oscillator to be tuned precisely to the center frequency of the discriminator. The meter reads 0 when the oscillator is on frequency, and is deflected sharply when the oscillator is detuned. When this adjust-

ment is made, wow and flutter percentages can be read directly from the meter by throwing the switch to 3 for a full-scale range of 3%, or to 1 for a 1% range.

Meter readings are in terms of peak flutter or wow voltage expressed as a percentage of the average signal frequency. The r.m.s. flutter present is approximately 70.7% of the indicated value.

The ZERO control is for resetting the 0 when switching between the 1% and 3% ranges. The switch marked DIS shorts the 1- μ f time-constant capacitor to increase the speed with which measurements can be made on different instruments or devices.

Each FL-3A is supplied with a 33 $\frac{1}{2}$ -r.p.m. calibration record with 2% peak-to-peak flutter. When played on a turntable that is within 1% of its 33 $\frac{1}{2}$ r.p.m. speed, the meter should read 1% (peak value). If it does not, the CALIBRATE control (on the rear of the chassis) must be readjusted. The manufacturer also supplies calibration tapes for 7 $\frac{1}{2}$ - and 15-inches-per-second speeds as optional accessories.

Intermodulation distortion

When two frequencies are applied to a nonlinear device, the output contains, in addition to the fundamentals and harmonics, spurious signals that are the sum and difference frequencies

formed by beating the fundamentals and harmonics. Many of these new frequencies, called *intermodulation products*, are not harmonically related to either of the fundamentals, therefore they are unpleasant to the ear. Examining the waveform produced by intermodulation of two frequencies, we will find that the higher is modulated by the lower and that the resulting pattern looks like an r.f. carrier modulated by an audio sine wave.

Measuring IM distortion

Two sine-wave voltages, one considerably lower in frequency than the other, are applied simultaneously to the input of the circuit under test. The output of the test circuit is connected to the input of the analyzer where it is amplified and passed through a high-pass filter that removes the low-frequency signal and leaves the high. If the test circuit introduces intermodulation distortion, the high-frequency signal will be amplitude-modulated by the lower. The amplitude of the high-frequency signal is set to a predetermined level and its amplitude is measured. The high-frequency or carrier signal is then rectified and the high-frequency components are removed by filtering, thus leaving only the low modulating frequency. The meter compares the amplitude of this residual voltage with the carrier and translates the difference in terms of percentage of intermodulation distortion.

The diagram of the Heathkit model IM-1 intermodulation analyzer is shown in Fig. 4. The 6J5 oscillator generates a carrier signal at 2,000 or 7,000 cycles, depending on the position of the fre-

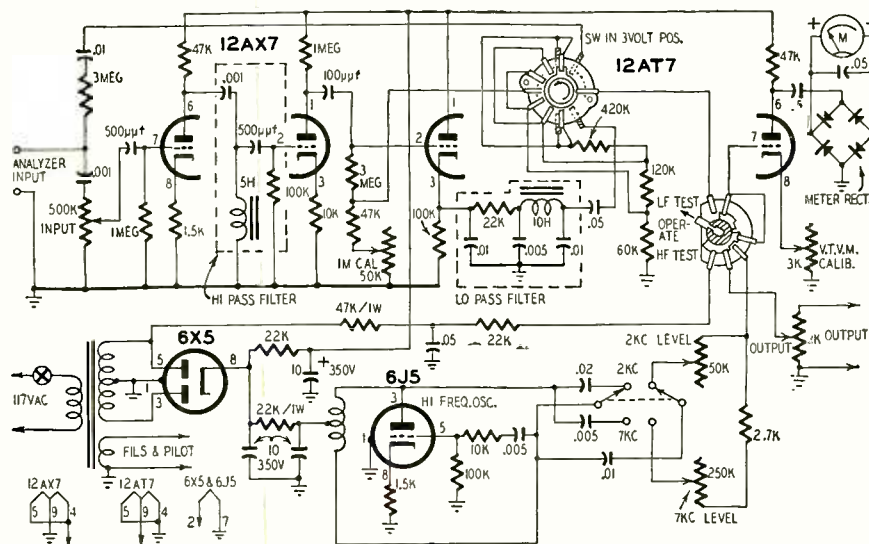

Fig. 4—Schematic diagram of the Heath-kit model IM-1 intermodulation analyzer.

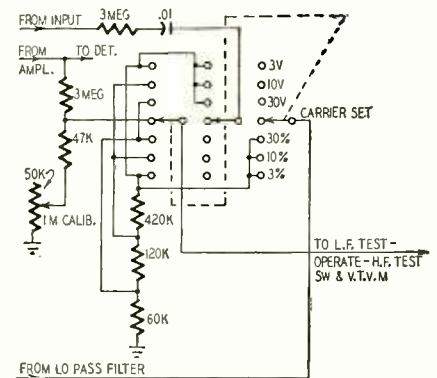

Fig. 5—Diagram of switching circuits.

TEST INSTRUMENTS

quency selector on the panel. A 60-cycle signal voltage is tapped off the rectifier plate and applied to the output control through a voltage-dropping network consisting of the 47,000- and 22,000-ohm resistors. The .05- μ f capacitor at the junction of these resistors filters out any 60-cycle harmonics that may be produced. The high- and low-frequency signals are mixed without distortion or intermodulation in the output circuit.

The ratio of the amplitudes of the two test signals is set with the level controls. These are usually set so the amplitude of the 60-cycle signal is 12 db above (four times higher than) the high-frequency test signal. The OUTPUT of the analyzer feeds into the input of the amplifier or circuit under test. The OUTPUT control sets the level of the signal applied to the amplifier. The output impedance is 3,000 ohms.

The analyzer or metering section of the IM-1 consists of a 12AX7 cascade amplifier with a high-pass filter between the stages. The filter provides maximum output at 3,000 cycles and the output is about 30 db down at 600 cycles. The output half of the 12AX7 feeds half of a 12AT7 working as an infinite-impedance detector. This circuit works into a low-pass filter cutting off at around 300 cycles.

There are two main switches in the metering section of the analyzer. The LF TEST-OPERATE-HF TEST switch is used when setting the ratio of the mixed test signals. In the LF TEST position, the v.t.v.m. measures the 60-cycle signal. The OUTPUT control is adjusted for full-scale deflection. Switching to HF TEST connects the v.t.v.m. across the output of the high-frequency generator. The desired signal level is set with the 2,000 LEVEL or 7,000 LEVEL control.

The seven-position switch is the range selector for the v.t.v.m. A simplified drawing of the switching circuits is shown in Fig. 5. Three positions are for measuring external audio voltages that may be applied to the INPUT terminals. Full-scale ranges are 3, 10, and 30 volts. The center (CARRIER SET) position is used for setting the input signal to the proper level. (The INPUT terminals are connected across the OUTPUT of the circuit being tested.) In this position, the v.t.v.m. connects to a voltage divider at the output of the second amplifier. The INPUT control is adjusted for full-scale deflection of the meter. The meter will then indicate percentage of intermodulation distortion when the switch is thrown to the 3%, 10%, or 30% positions.

Owners of model IM-1 intermodulation analyzers can improve the frequency response of the voltmeter by replacing the meter rectifier with a pair of 1N35 matched diodes. The instrument can be converted temporarily to read peak values of complex signals by replacing the .05- μ f capacitor across the meter with a 50- μ f, 25-volt unit and readjusting the calibration control. END

Novel Frequency Measuring Method

If you own an accurately calibrated, stable, low-frequency oscillator, and a signal tracer, you can—with a high degree of accuracy—calibrate an oscillator or transmitter of an unknown higher frequency by listening for easily identified beats and making a few simple calculations.

The output of the low, variable-frequency oscillator and a portion of the output of the high-frequency oscillator are fed into the input of a signal tracer. The frequency of the low-frequency oscillator is then varied, producing a number of beats that can be heard at the output of the signal tracer. These beats are the result of heterodyning between the harmonics of the low-frequency oscillator and the fundamental and harmonics of the high-frequency oscillator. Between the loud-beat positions on the dial of the low-frequency oscillator will be beats of lesser intensity. The loud beats and their positions on the tuning dial are significant in determining the frequency of the high-frequency oscillator, as they indicate the points at which the harmonics of the low-frequency oscillator beat with the fundamental of the high-frequency oscillator.

Note the dial reading at which a loud

beat occurs. Vary the frequency slowly (higher or lower) until another loud beat occurs. Then divide the product of the two loud-beat frequencies by their difference. The result will be the unknown oscillator frequency. Mathematically this can be expressed:

$$f_3 = \frac{f_1 \times f_2}{f_1 - f_2}$$

where f_3 is the unknown high frequency, f_1 is a frequency at which a loud beat occurs, and f_2 is the frequency of the next lower beat.

For example, if a loud beat is heard at 5760 kc and the next lower loud beat is heard at 5400 kc, then:

$$f_3 = \frac{5760 \times 5400}{5760 - 5400} = 86,400 \text{ kc}$$

—Sidney Appleby

(Calibrating an oscillator or any other signal source is much easier if you know its approximate tuning range. You can use a grid-dip meter, wavemeter, Lecher wires, or a receiver covering the desired frequency range or its low-order harmonics. Don't overlook the possibilities of TV and FM receivers.—Editor) END

A PHASE-ANGLE PROBLEM

A LOT of my TV repair work is drive-in business. The customer delivers his set to my shop, then picks it up again after I've tinkered with it. One evil day, a 16-inch Admiral chassis was set on my bench by a gentleman of amiable disposition, but with a rather indifferent command of English. We didn't need any interpreter to point out the complaint. That was obvious, although slightly unusual. Sound was O.K. but the raster was a mere half inch or so in width, centered in the C-R tube. But no other information could I learn from him.

The trouble lay beyond the horizontal oscillator, because the scope showed a sawtooth of adequate height, proper shape, and proper frequency, at pin 5 of the 6CD6. Tube substitution turned up absolutely nothing.

I dug a little deeper and discovered that the waveform at the damper was O.K.; likewise for shape of sawtooth current in yoke. Clipping out the width coil didn't change the width of the picture a millimeter. A check of components in the area uncovered not a clue; whereupon, I shoved the job aside. Out of expensive experience I've decided that if a case of trouble can't be nailed within an hour, any further effort at the moment is usually wasted time. I keep rolling the problem around in the back of my mind as I went about other matters—for sooner or later I may get a sudden inspiration which often winds up the job in a hurry.

No brain waves developed in the case

of this 16-inch Admiral. Late the next day, with everything double-checked and triple-checked, I'd gotten clear inside the yoke, checking for grounds, and possible connection between windings. I even measured the capacitance of that little capacitor across one-half of the horizontal section; checked it for leakage.

It wasn't exactly an inspiration which hit me then; more a hunch. I began pulling tubes in the chassis—no particular idea in mind—and all of a sudden I pulled one which reduced picture width to just about zero, a thin vertical line. The tube was a 6W6, which happens to be the vertical output tube in that particular box. In the tube checker it showed up flat as a rug. I plugged in another 6W6 and the raster spread out and filled the tube.

My pleasure was short-lived. The raster lines were running vertically instead of horizontally—this was the payoff! After I batted my eyes for about the third time, I realized that this particular chassis happened to be one of those side-winders found in some Admiral consoles, where the whole shebang hangs with its base vertical in the cabinet and the control knobs run up the left-hand side of the screen instead of horizontally across the bottom as they do in all proper boxes.

My customer had brought in a chassis, remember—no cabinet. The language barrier obviated any chance of picking up a clue which I might have got otherwise. —H. A. Highstone

Constructing an inexpensive, dependable multimeter

Pin-Jack MULTI-METER

By I. QUEEN
EDITORIAL ASSOCIATE

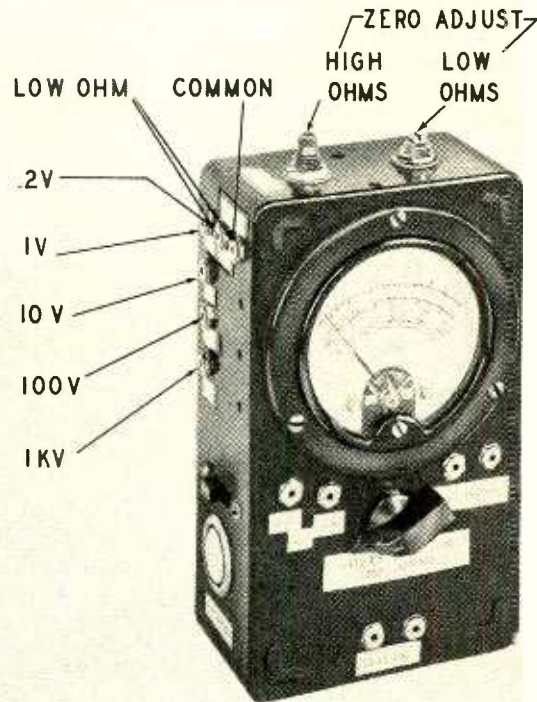

The pin-jack multimeter—pin-jacks everywhere.

THE nonelectronic type of voltmeter has become very popular. It has certain important advantages over a v.t.v.m., being more compact and not depending upon a line or battery power supply. It cannot drift or introduce circuit errors as in a v.t.v.m. Furthermore, there is no warmup period and there are no tubes to age. If, in addition, the instrument has high sensitivity, it compares favorably with the v.t.v.m. in the matter of high input resistance. For example, with a 10- μ a movement an instrument has an input resistance of 100,000 ohms per volt. This totals 10 megohms on a 100-volt scale, which approximates the input resistance of a conventional v.t.v.m.

I have designed a multimeter using a 40- μ a basic movement (25,000 ohms per volt). A number of interesting features were incorporated. The instrument uses phone pin-jacks. A multipole rotary switch is usually expensive, difficult to wire up, and is often the source of mechanical trouble. A low current range has been included to measure a.c. in the order of 1 μ a. This uses a trans-

sistor amplifier. There are high and low ohms ranges, and two low a.c. volt ranges. The low ranges are useful when experimenting with junction transistors. There are 15 different ranges altogether. The beauty of the pin-jack arrangement is that more circuits can always be added if desired; the only thing necessary is space on the meter box for additional pin-jacks.

Unfortunately, meter sensitivity and internal resistance have never been standardized. Values vary from one manufacturer to another. If you intend to use a surplus type movement, make sure you know the value of its internal resistance. Internal resistance can be measured by using the circuit shown in Fig. 1. A variable resistor, R1, is placed in shunt with the meter. A second resistor, R2, is in series with a d.c. supply which may be a single 1.5-volt cell. Adjust R2 for full-scale meter deflection with the switch open. Close the switch and adjust R1 for a midscale reading. The meter resistance is equal to the value of R1, which may be read off on a bridge or ohmmeter. R2 should

always be much larger than R1. Watch that you always have enough resistance in it to avoid damage to the meter!

Voltage

Fig. 2 shows the voltage range circuit. It is in use when the selector switch is rotated to the VOLTS tap. Connections to the other positions are not shown in Fig. 1. To design the volts range we must know the ohms-per-volt value for the particular d'Arsonval movement to be used. If the meter has a full-scale sensitivity of 10 μ a, it requires a total series resistance of 100,000 ohms to measure a full scale of 1 volt. This means that the meter is a 100,000-ohms-per-volt unit. In the same way, a 20- μ a meter is a 50,000-ohms-per-volt unit.

If you have a 20- μ a, 2,050-ohm meter, a series resistance of 50,000 ohms is required for every volt (full-scale) you wish to measure. Therefore, in Fig. 2, you need 50,000 minus 2,050 ohms for R1. For R2 you need a resistor that will drop 9 additional volts. At 50,000 ohms per volt, this comes to 450,000 ohms. In the same way you can easily calculate all other series resistors. Of course you may not wish to have ranges as marked in Fig. 2. You may prefer 5 volts, 25 volts, or any other. In any case, the computation is the same. You may include as many ranges as you have room for pin-jacks. The ranges you choose, however, should correspond to the markings on the meter scale. If your full-scale reading is 15, you will probably want to use 1.5 volts, 15 volts, 150 volts, etc.

To measure volts in Fig. 2, one test lead is plugged into the COMMON or

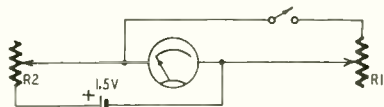

Fig. 1—Measuring internal resistance.

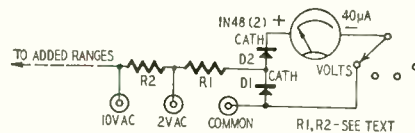

Fig. 3—Circuit for a.c. voltage range.

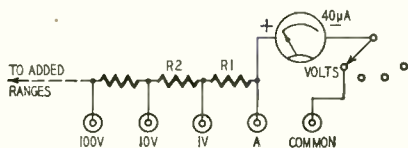

Fig. 2—Circuit for d.c. voltage range.

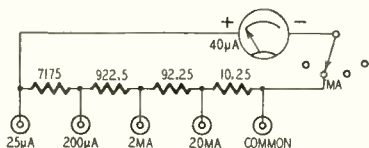
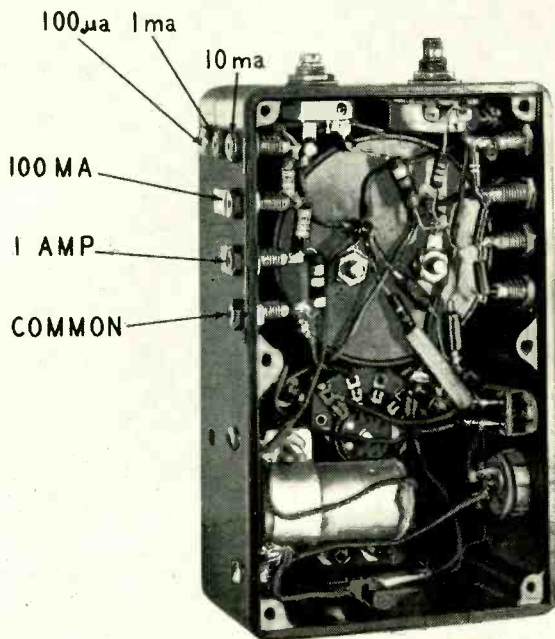

Fig. 4—The Ayrton shunt circuit.

TEST INSTRUMENTS



View of the meter's internal wiring.

minus pin-jack; the other lead is inserted into the desired voltage pin-jack.

For a.c. volts, I used the circuit shown in Fig. 3. This particular instrument has only two low ranges—2 volts and 10 volts. These have been found very valuable for transistor output measurements. A pair of crystal rectifiers are used across the meter. One half of the a.c. wave is passed through the meter. The other half is shunted out by a crystal and does not flow through the meter. (When the COMMON pin-jack goes positive, D1 is conductive and D2 is blocked. Thus current flows through D1 and not through the meter.) The resistors for these ranges must be found by experiment. This meter has a 40- μ a movement. It requires a 2,700-ohm resistor for R1 and 82,000 ohms for R2. The meter resistance is 5,000 ohms.

To measure a.c. volts, the range switch is left in VOLTS as for d.c. measurement. The leads are plugged into the COMMON and desired a.c. volt pin-jack. The rectifiers across the meter have no effect on the other meter ranges.

Current

Measurements of current are made by using the Ayrton shunt circuit (Fig. 4). The meter is shunted at all times by a ring of resistors. One test lead is inserted into the common ma pin-jack, the other into the desired current pin-jack.

An Ayrton shunt is calculated by the formula

$$R_s = \frac{R_m + R_n}{N}$$

Where R_s is the total shunt around the meter, R_m is the meter resistance, R_n is the resistance of the tapped section between the pin-jacks being used, and N is the multiplier number. If we have a 50- μ a meter and wish to measure 500 μ a, N would be 10.

Fig. 4 shows a network which can be used for a 20- μ a movement with a meter resistance of 2,050 ohms. First we must decide on the lowest current reading we want. Let it be 25 μ a. We must then shunt 5 μ a around the meter and permit the other 20 μ a to flow through it. If the shunt resistance is four times the meter resistance, the requirements are met. Therefore R_s must be 8,200 ohms—we know that R_m is 2,050 ohms. In this case N equals 1.25. For N equals 10 (fullscale reading of 200 μ a) R_n is 1,025 ohms, etc. In this way, the remainder of the network may be calculated. As with volts, we may add as many ranges as we desire, the only limiting factor being the space we have for more pin-jacks.

One question may come up here. The constructor may wish to use the lowest possible current range, for example, 20 μ a in the previous case. This is not possible with a ring shunt. To do this, switch the instrument to VOLTS to disconnect the shunt, and insert your test leads into pin-jacks which connect directly to the meter terminals. These are shown as jacks "A" and "common" in Fig. 2.

Ohms

The ohms network is a little more complicated than either current or voltage circuits (Fig. 5). Of course the

meter you use must carry ohms scales, as well as volts and ma. Many of the available surplus type meters have this feature. If not, you can convert the meter by removing its scale and replacing it with one that includes ohms. We will assume here that the meter carries both a *high* ohms scale (reading from right to left) and a *low* ohms scale (reading from left to right).

To design the *high* ohms network, note the ohms reading that corresponds to meter midscale. In my particular meter this happens to be 30,000 ohms. With HIGH OHMS pin-jacks shorted we want full-scale (or zero ohms) deflection. With 30,000 ohms across the pin-jacks we want mid-scale reading. Obviously we need an ohmmeter circuit having a total internal resistance of 30,000 ohms (this includes meter resistance). This circuit can be traced in Fig. 5 as follows: R1 is the series resistor, in series with the HIGH OHMS pin-jacks (when selector switch is on ohms), the battery, and the meter. When the pin-jacks are shorted we want the battery to drive full-scale current through the meter. When 30,000 ohms is placed between the pin-jacks we double the total series resistance, therefore we halve the meter current.

This completes the high-ohms circuit except for one problem. What if the series resistance (30,000 ohms for our particular meter) is not correct for securing full-scale deflection? It may be too large or not large enough. In our own case it was not large enough. If you calculate the flow due to 1.5 volts through 30,000 ohms you will get 50 μ a, yet we are using a 40- μ a meter. Then all we have to do is add a shunt, R2. If R2 is 4 times as large as the meter resistance (5,000 ohms) I found that it would pass 10 μ a when the meter flow is 40 μ a. This satisfied all conditions and our high-ohms range was complete. On the other hand, it is possible for the series resistor R1 to be too large. It may not permit sufficient current to fully deflect the needle. Then the battery voltage must be increased. Add cells until R1 is just right or until it permits too much current flow through the meter. Then add a shunt as just described.

For convenience, R1 is shown as a

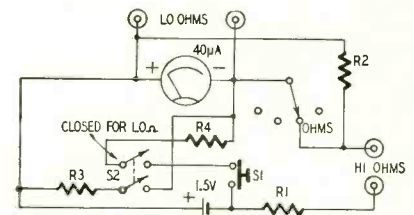

Fig. 5—Resistance measuring circuit.

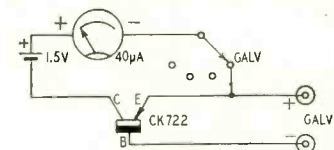

Fig. 6—A highly sensitive circuit.

single unit. However, it should be composed of a variable portion and a fixed portion. Thus we can compensate for an aging battery. The variable resistor may be about 20% of the total. In my own case, R1 should be 26,000 ohms because the meter (5,000 ohms) is shunted by R2 (20,000 ohms). The solution was to use a 24,000-ohm fixed resistor in series with a 5,000-ohm potentiometer. The potentiometer is adjusted by shorting out the pin-jacks and setting for full-scale deflection.

The low-ohms circuit includes a push-button switch S1 and a d.p.s.t. slide switch S2. On this range, zero ohms is at the extreme left and the scale reads upward. Again note the ohms reading that corresponds to mid-scale on the meter. In my case it happened to be 16 ohms. This gives the value of R3, a shunt resistor placed across the meter terminals and the low ohms pin-jacks, when S2 is closed. With the push-button switch, S3, also closed, R4 permits current flow from the battery into the meter. With the LOW OHMS pin-jacks left open, this current must be sufficient to produce full-scale deflection. Then if we place 16 ohms across the jacks we find that the reading drops to mid-scale as required. The smaller the resistance across the pin-jacks, the lower the meter reading.

Now for the design work. In most cases R3 is so much lower than the meter resistance that the latter may be ignored. In any case we want the resistance across the pin-jacks to equal the mid-scale ohms reading (16 ohms in my particular case). The limiting resistance, R4, produces full-scale deflection when the pin-jacks are left open. For my instrument, I calculated the total current flow when my meter showed full-scale deflection. The meter would pass 40 μ a, of course. The 16-ohm

shunt would pass $\frac{5,000}{16}$ or 312 times

as much. This is 12.5 ma, so we may ignore the very much smaller meter flow. How much series resistance do we need to permit 12.5 ma from a 1.5-volt battery? The answer is 125 ohms, of which we already have 16 ohms between the meter terminals. Therefore R4 should be about 110 ohms. As before, it should be partly variable. I used a 91-ohm fixed resistor in series with a 30-ohm potentiometer. To adjust this range, leave the pin-jacks open and adjust R4 for full-scale deflection. Be sure S2 is closed and depress the push-button when you make the measurement.

The slide switch serves another useful purpose. When left closed it places 16 ohms across the meter. This damps out the movement and prevents the needle from bouncing around while the instrument is being handled. This is not necessary when the meter is used for volts, ma, or high ohms.

Galvanometer

This range measures weak currents or voltages. High accuracy is not re-

quired for most of these measurements, but high sensitivity is. Fig. 6 shows the schematic. The input current or voltage is impressed across the GALVONOMETER pin-jacks.

Present-day transistors don't have uniform and identical collector current flow. For the galvo application, the transistor should show low current when the input terminals are left open. This eliminates the need for an auxiliary circuit to balance out and zero the meter deflection when no input is applied. The transistor used here shows only 4- μ a collector current with the terminals open.

To calibrate the galvo range, apply various known currents between base and emitter. The emitter is the positive terminal. Linearity will not be perfect but it should be very good. This instrument shows a 4- μ a deflection for each μ a fed to it, giving an easy and convenient method for increasing the sensitivity of a d.c. meter.

To read volts, add a resistor in series with the negative (base) lead. I used a 1-megohm series resistor, and the meter deflects approximately 4 μ a for each

volt applied. For better accuracy, draw a curve or chart plotting μ a meter deflection vs. μ a input (or volts input). To increase sensitivity, use a larger collector battery.

This multimeter has four functions: volts, current, ohms, and galvo. Ordinarily this would require a 4-position, single-pole switch, not a very common part. Therefore I "doctored" up a 3-position switch for this purpose. It is a Centralab unit with 4 terminals. Originally the tap could contact only 3 of them, the "common" terminal being excluded. By filing off the stop, the movable tap could also touch the common terminal—and I had a 4-position switch. This common terminal is used for the volt range, the only one that does not require a shunt or external circuit across the meter.

All parts used in this multimeter are easy to obtain at any radio store. The only expensive components are the meter and the transistor. The instrument has proven itself over many months. It has been used for experimental work, servicing, and ham-radio measurements.

END

Spot-Checking the Grid-Dip Meter

By HAROLD REED

Having purchased, assembled, and wired my Heathkit grid-dip meter, the next step was to run a test to see if it would perform on all frequencies according to the manufacturer's claims.

My home laboratory layout consists of communications receivers covering the frequency spectrum up to 50 mc; transmitting equipment for working up to 28 mc—then jumping to 420 mc; and a signal generator designed to operate to 120 mc.

The frequency range of the grid-dip meter is 2 to 250 megacycles. The manufacturer suggests that the ready-calibrated dial supplied with the kit can be more accurately adjusted with a calibrated receiver or signal generator. In my particular case, up to 50 megacycles presented no problem. I used one of my communications receivers. Above this range I tried the signal generator, hoping to extend the test to 120 mc, but found that the signal generator output was not great enough to be read on the grid-dip meter.

The grid-dip meter has a switch on the back of the case that makes it possible to use it as a high-frequency oscillator from 2 to 250 mc, or as a diode detector, when it is to be used as an absorption type wavemeter. Therefore, using it as a diode detector I tested the unit with my transmitting gear up to 28 mc. As a high-frequency oscillator it checked satisfactorily up to 50 mc with the communications receiver.

But was the instrument oscillating with the higher-frequency plug-in coils in the circuit?

Having an FM tuner, I decided to use it for spot-checking in the 88-to-108-mc band. With the tuner set to various FM

broadcast stations, and the grid-dip meter switch in the oscillator position, as the meter was tuned to the frequency of each FM station the radiated signal from it was great enough to completely blank out the signal from the station. I was satisfied that the instrument was performing satisfactorily to over 100 megacycles.

Now remained only the higher range, up to 250 mc. Having used the FM receiver, the thought came to mind, why not the television set? I chose a time that would not interfere with the wife's favorite television shows, and checked through from the lowest to the highest TV channel. As the meter was tuned to the video carrier the picture completely disappeared from the screen; when the meter frequency approached the sound carrier the sound became inaudible. These tests were made with the grid-dip meter 10 feet away from the television set.

Having made these tests through channel 13, I was satisfied that the instrument was operating normally to approximately 216 mc. Since the instrument was still oscillating vigorously at this frequency, there was no doubt in my mind that it would perform satisfactorily throughout its range.

This grid-dip meter was wired carefully, using short and direct leads as recommended by the manufacturer. By just setting the ready-calibrated dial according to these instructions, it was astonishing how well the frequency indications on the dial of the instrument agreed with the signal frequencies of the FM stations and with both the picture and sound carriers of the television stations.

END

Transistor AM Test Oscillator

An extremely small and portable instrument for servicing radio receivers

By EDWIN BOHR

THIS pocket-size, battery-operated, transistor oscillator generates four spot frequencies for testing and servicing AM receivers. The frequencies are 455 kc, 600 kc, 1 mc, and 1.4 mc. These signals may be modulated or unmodulated. In addition, the oscillator will supply an audio signal for testing audio stages. The oscillator, in combination with a volt-ohmmeter, will lick just about any AM service job.

The oscillator is fine for i.f. alignment, tracking front-ends, and troubleshooting by signal injection. In contrast to signal tracing, signal injection makes the receiver under test supply all the amplification. Where a signal tracer must have many stages of amplification and a loud speaker, the signal injector may be a one-stage oscillator.

For signal-injection testing, hold the oscillator in one hand and move it from stage to stage, starting from the output tube and moving forward into the i.f. and r.f. stages. The trouble is located immediately behind or in the stage where the signal disappears.

Intermediate-frequency stages can be aligned with the 455-kc signal. Tracking is checked at the standard test frequencies of 600 kc, 1 mc, and 1.4 mc. And remember, the entire oscillator fits easily into a shirt pocket.

Test Oscillator

The instrument (Fig. 1) uses a single CK722 junction transistor. At audio frequencies this transistor operates on even less than 1 volt. However, at broadcast frequencies, most CK722

transistors require at least 15 volts. They are not designed to operate on the broadcast band. But, at this voltage, the operation is sometimes erratic, so a 22.5-volt battery is used for the collector supply. This voltage assures easy oscillation and greater interchangeability of transistors.

The four test frequencies are obtained by switching capacitors across the collector tuning coil L1. Coil L2 is a tickler that feeds energy back into the emitter where it is reamplified by the transistor.

Fixed mica capacitors shunt the tuning trimmers for the two lowest frequencies. This "bandspreads" the trimmer tuning and makes the calibration adjustment easier.

Switching C3 across R1 produces audio modulation of the r.f. carrier and the audio test signal. The frequency of this modulation varies with individual transistors and may vary from a slow putt putt to several hundred cycles. The more actively the transistor oscillates, the lower the frequency of the modulation. If the frequency is too low, the oscillator will put harmonics all across the broadcast band when switch S2 is in MOD position. This is not always desirable. The modulation frequency in this case may be raised by decreasing the value of C3. The 1-mh choke prevents the r.f. signal from bypassing to ground when C3 is switched in.

An oscillogram of the oscillator's AM carrier is shown in Fig. 2. The modulation is greatly in excess of 100%. The r.f. is periodically blocked off completely. A.f. oscillations decrease the positive bias on the emitter until the oscillations stop. The emitter then begins to return to a higher positive bias as C3 recharges. When the bias reaches a high enough value, the r.f. oscillations begin again. The positive emitter bias comes from the divider network R2 and R3.

Capacitor C6 has appreciable reactance compared to the emitter input impedance. Therefore, should you wish to operate the oscillator at frequencies lower than 455 kc, the value of C6 must be increased accordingly.

When the frequency selector is rotated to any of the four spot frequencies, the unit is turned on. A fifth contact is the OFF position. With this arrangement, the operator is more like-

ly to turn the oscillator off and not run down the battery.

A single jack serves for both the audio and r.f. test signals. The jack is isolated from the transistor circuit by C5. Since the output is taken from the low-impedance emitter circuit, the oscillator is virtually immune to loading effects. No ground jack is included to ground the oscillator to the circuit being tested. The reason is this: If the oscillator case were grounded and the oscillator output jack were accidentally connected to a high-voltage a.c. wire in the receiver, there might be enough signal coupled to the emitter, through C5, to damage the transistor.

Construction

The design of a good layout for small pieces of electronic equipment is more difficult than seems obvious. A 1½ x 2½ x 3¼-inch aluminum case houses the oscillator. Volume-wise there is adequate space, but the size and shape of the parts is such as to oppose arrangement.

If the oscillator is built in the same size box that I used, follow the drilling details of Fig. 3; this is the only way the parts will fit. Some aluminum cases are made from 1/16-inch stock; others are made of less rigid stuff.

The measurements of Fig. 3 are based on a 1/16-inch wall thickness. Other boxes may require a slight revision of these measurements to compensate for a different thickness.

The largest component is the selector

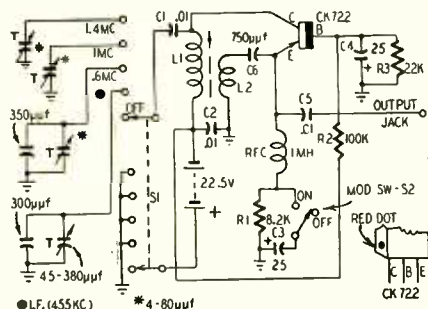

Fig. 1—Schematic diagram of the transistor AM test oscillator. For stable operation, a 22.5-volt battery is used for the unit's collector supply.

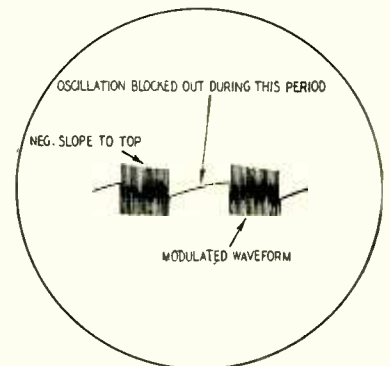

Fig. 2—Oscillogram of oscillator's AM carrier. Modulation exceeds 100%.

switch—one of the new miniature PA-1000 series made by Centralab. The trimmers and their shunt capacitors are wired to this switch. The selector switch also acts as the support for the phenol-board chassis. The chassis contains two holes that slip over the switch bolts. Two 4-40 nuts then hold the chassis board to the switch.

The exact chassis size is shown in Fig. 4. A 5-pin hearing-aid tube socket is used for the transistor and the cutout dimensions are for this type of tube socket.

Other holes must be cut in the chassis.

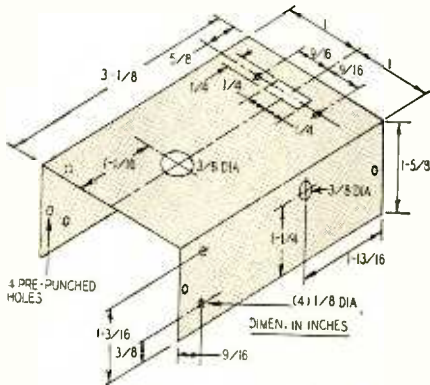

Fig. 3—Layout for the aluminum case.

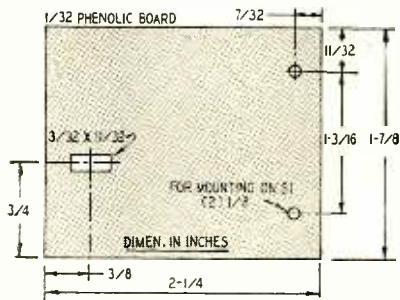
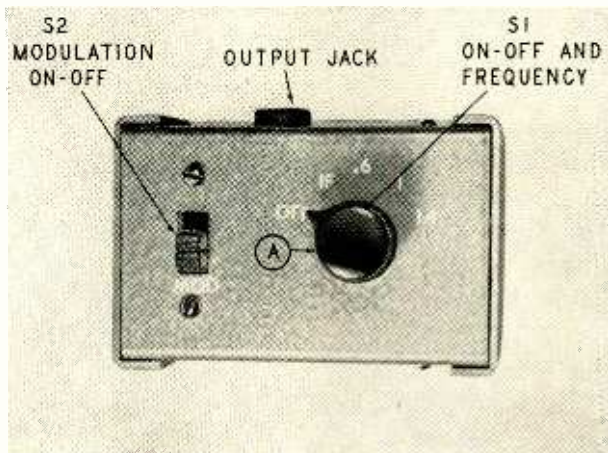

Fig. 4—Chassis layout dimensions.

Components are rigidly mounted to the board by pulling through and soldering their leads to the other side. Even the coil is mounted this way. The position of these holes is best determined by placing the component directly on the board and marking the best hole location.



Front-panel view of test oscillator.

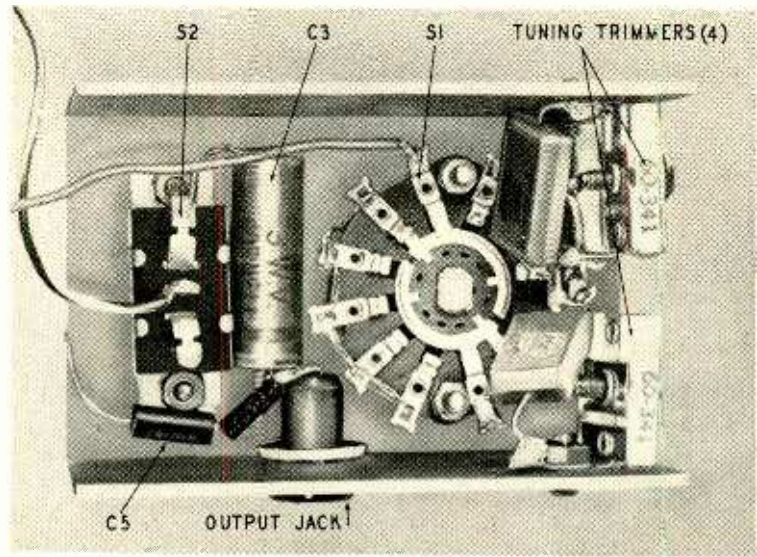

Fig. 5—Components mounted to case.

Several of the parts are mounted to the case under the chassis board (Fig. 5). The loose wires from these parts are soldered to appropriate tie points on the chassis board once it is in place and mounted to the switch.

Coil L1 is a Ferri-Loopstick, modified by removing all of the unnecessary coil form to reduce the size. The number of turns on the coil is unchanged and the slug is centered lengthwise in the coil for maximum inductance. Coil L2 is wound directly over L1 as shown in Fig. 6. Coil L2 is 7 turns of any convenient-size wire. If the coil is wound as shown in Fig. 6, the connections can be made with the assurance that the feedback polarity is correct for oscillation. (But if there are no oscillations, try reversing it!)

Capacitors C1, C2, and C5 are sub-miniature paper units made by Aerovox. The electrolytics are 3-volt d.c. units made by Cornell-Dubilier. C4 may be operated slightly beyond its rating but there will be no difficulty. It is important that the smallest parts obtainable be used. The battery is a small unit made especially for photo-flash purposes.

Calibration and use

An easy way to calibrate the oscillator is to track it with a communications receiver. Ordinary broadcast receivers are usually too poorly calibrated. The 455-kc spot could be set by adjusting it until the second harmonic is picked up at 910 kc. Another way to set the 455-kc trimmer is to feed the oscillator output directly into the i.f. stages of a receiver and adjust the oscillator until it generates a 455-kc signal. If this procedure is followed it is advisable to short out the oscillator section of the receiver beforehand.

There are many stations on 600 kc, 1 mc, and 1.4 mc and at least one station can be received on each of these frequencies. These stations can be used for calibration. For example, tune in a 1400-kc station, turn the transistor oscillator knob to the 1.4 position, and turn the 1.4 trimmer all the way in. Now back off the trimmer about 1/2 to 1 1/2 turns. The oscillator should be heard as it passes 1400 kc. Place the modulation switch in the OFF position and slowly adjust the oscillator trimmer until it zero-beats with the station. All the trimmers will be adjusted within a turn or so of complete closure when they have been tuned to their proper frequency.

The accuracy of the 600-kc adjustment can be ascertained by checking the 600-kc harmonic at 1200 kc. Also, the third harmonic of 455 kc falls in the broadcast band at 1365 kc. For most work with the oscillator, the calibration

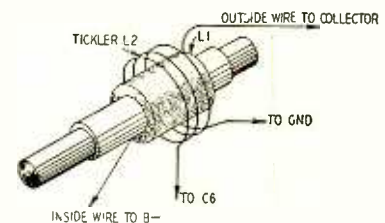
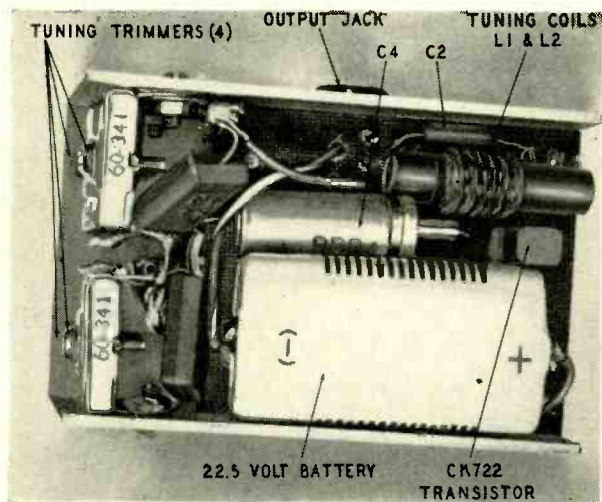
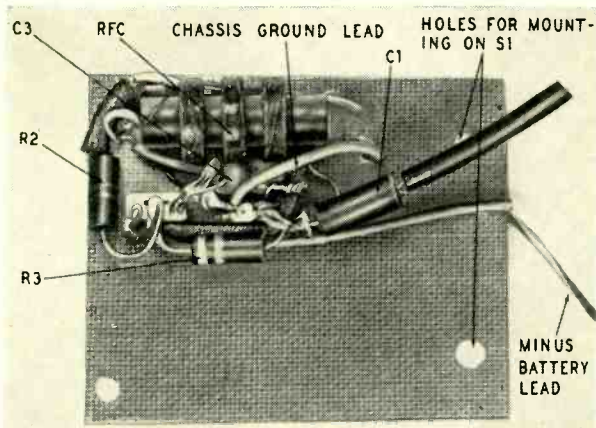

Fig. 6—Coil-modification details.

TEST INSTRUMENTS



Parts layout—
top side of
chassis.



Under-chassis
view of test
oscillator.

does not have to be particularly precise.

Drift is very small. There is some drift when the oscillator is first turned on, but it takes only about a minute to stabilize. Compared to the 15 or more minutes warm-up for a vacuum-tube oscillator, this is very good. The large amount of tuning capacitance used at 455 kc lowers the tuned circuit impedance and gives the greatest stability.

The oscillator is simple to use. Suppose we want to check the audio stages of a receiver. Plug a short length of stiff wire or test-lead into the output jack and place S2 at MOD. Whenever the oscillator is in that position the audio test signal is available at the jack since C5 is large enough to pass both audio and r.f. In other words, both the modulated r.f. and audio are available at the same time.

The wire or probe can now be touched to various points of the audio circuit and the test signal should be heard. For example, if the signal disappears on one side of a coupling capacitor and is present on the other side, the capacitor is obviously open. If by signal injection one of the stages is shown to be inoperative, a voltage check usually locates the trouble. Essentially the same procedure is followed in servicing r.f. stages by signal injection.

A strong inductive field is created around the test oscillator by the Ferri-Loopstick. Receivers with loop antennas are very sensitive to this field and can pick up the oscillator many feet away, even though it has no probe or antenna plugged into the output jack. As the oscillator is slowly rotated in one hand, the signal strength from the inductive coupling to the loop-antenna will change tremendously. In some positions a complete null will be reached and in others the signal will be terrific. A 455-kc signal can be fed into some i.f. transformers this way.

Parts list for AM test oscillator

Resistors: 1—8,200, 1—22,000, 1—100,000 ohms, 1/2 watt.
Capacitors: 1—300 µf, 1—350 µf, mica; 1—750 µf, ceramic; 3—.01 µf, 200 volts, paper; 3—4-80 µf, 1—45-380 µf, trimmer; 2—25 µf, 3 volts, electrolytic.
Miscellaneous: 1—CK722 transistor; 1—5-pin sub-miniature tube socket; 1—Ferri-Loopstick; 1—1-mh r.f. choke; 1—22.5-volt battery; 1—Centralab switch, PA1002; 1—s.p.d.t. slide switch; 1—aluminum case, 1 1/2 x 2 1/4 x 3/4 inches; 1—knob; 1—insulating board; 1—output jack.

There are other uses for the oscillator. You can make a wireless code-practice oscillator out of the test unit by substituting a telegraph key for S2 and reducing the value of C3 for a sharp practice tone. **END**

CONTINUITY TESTER

Most service technicians at one time or another have tested multiconductor cables for opens or short circuits while trouble-shooting defective PA or intercom installations, or radio or TV remote controls. This task is laborious and time-consuming because each conductor must be tested individually for shorts and opens. Tests on multiconductor cables are simplified by a new continuity tester invented by Jesse A. Cranford, of Buffalo, N. Y., (patent No. 2,610,229) and assigned to Western Electric Co. The circuit shown is for simultaneous testing of four conductors. A method of simultaneous testing of five conductors is also described in the patent.

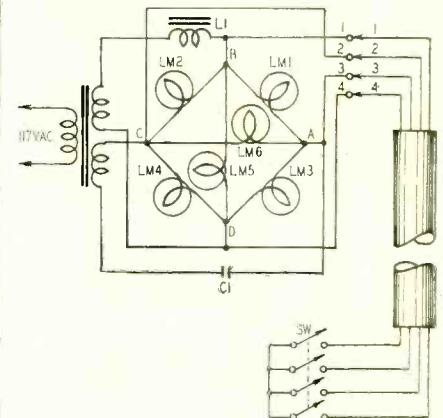

The test circuit is basically a Wheatstone bridge with indicator lamps in each arm and in the leads connecting each pair of diagonal corners (A-C and B-D). The four conductors to be tested are connected to the corners of the bridge (points A, B, C and D) as shown. Points A and C and B and D are fed with equal voltages from secondary windings on a transformer. Inductor L1 and capacitor C1 are inserted in the circuit so the applied voltages are 90° out of phase. This phase difference permits all the lamps to light when there is no short circuit between any of the corners.

When testing a cable, conductors 1, 2, 3, and 4 are connected to corresponding terminals on the bridge. Should there be a short between any pair of conductors, the bridge corners to which they connect are shorted together and the lamp between them goes out. A short between conductors 1 and 3 short-circuits A and B so LM1 goes out. Similarly, a short between conductors 1 and 2 extinguishes LM2. A simultaneous short between all conductors places all bridge terminals at the same potential and all lamps go out.

The switch is closed to short all conductors together at the far ends so they can be tested simultaneously for continuity. All lamps will go out unless there is an open circuit in one or more of leads. For example, if lead 4 is open, there is no short circuit between bridge terminal D and terminals A, B, and C so LM3, LM4, and LM5 would not be extinguished. By glancing at the lamps you can tell which, if any, of the conductors is open.

VERTICAL INTERLACE *and* INSTABILITY

*The causes and cures of troubles
in the vertical oscillator circuit*

By MATTHEW MANDL*

LACK of interlace—or intermittent interlace—in a TV receiver indicates critical vertical synchronization. If you can't get good interlace with the vertical hold control, be forewarned of trouble in the vertical oscillator circuit.

Believe it or not, many service technicians think they have good interlace when the horizontal line structure is clearest and easiest to see. The opposite is true. When interlace is lost, we have line pairing, and the horizontal line structure becomes coarser and so *more visible*. When the interlace is good, the horizontal line structure is much fainter, and twice as many lines are present. So the picture on a large screen appears less coarse and grainy.

The underlying principles

In television transmission 262.5 horizontal lines are transmitted in 1/60 second. This is known as a *field*, and two such fields make up a *frame* of 525 lines, each 1/30 of a second. The two fields are interlaced; that is, the horizontal lines of the second field fall between the horizontal lines traced by the first field. This interlaced principle of transmission increases the vertical resolution by doubling the number of lines visible, and also eliminates flicker.

When the two fields are not interlaced properly, the results are noticeable in a station pattern because of the effect on the horizontal wedge (Fig. 1). Notice that it has a lacy, moiré effect. This results from line pairing. A close inspection of the screen reveals a coarse horizontal line structure.

When the two fields are interlaced properly, the fine line structure makes the horizontal wedge look like Fig. 2. The lines are more clearly defined and are not interrupted by the moiré effect. Even with poor focus the line structure would still be unbroken.

In a receiver operating normally, the interlace loss effects shown in Fig. 1 can be duplicated by adjusting the vertical hold control near the point where sync instability occurs. At this critical setting interlace is lost and the line structure becomes coarse. The same condition exists when synchronization is

Linearity is best checked with the dot pattern, as shown in this photograph.

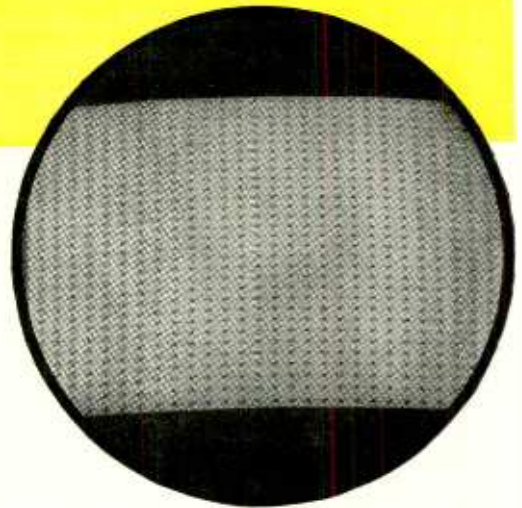

lost and the picture rolls. This can be seen by adjusting the hold control so the picture rolls slowly and noticing the line pairing and coarse structure of the horizontal scan.

Since interlace can be lost if the hold control is adjusted near the point where synchronization is critical, the vertical hold control must be adjusted below that critical point. Proper adjustment not only restores interlace, but also prevents the occasional picture roll during impulse interference (such as generated by turning on a light in the house). If the vertical hold control range is limited, try a new vertical oscillator tube. If this does not help, check circuit components for off-value conditions. Two most likely circuits are the hold control resistive-capacitive network, as well as the R-C network which precedes the vertical oscillator.

This R-C network is known as the "integrator." A typical circuit is shown in Fig. 3. It has the dual function of filtering out the 15,750 horizontal sync pulses from the vertical system, as well as building up a charge from the incoming vertical sync signals. Thus, good stability in a vertical oscillator system depends to a considerable extent on the circuit values of the integrator network. Because a charge must be built up to a high enough level to overcome the negative potential on the vertical oscillator tube, the capacitors of the integrator network must have a good power factor so that leakage will not upset the charging level. Tube conduction in the oscillator starts the retrace portion of the vertical sawtooth developed at the output of the oscillator.

Since each field has some 262.5 lines, the half-line interval causes the vertical oscillator to be synchronized at a slightly different time interval for each successive field. If the vertical hold control is not adjusted properly, it will change the relationships of the free-running frequency of the vertical oscillator with respect to the timing charge which accumulates on the integrator network. Even though synchronization is not lost, line pairing will result. The same holds true if some component defect contributes toward intermittent vertical stability or loss of vertical synchronization.

Observe the screen to determine whether or not interlace is correct, and adjust the hold control to ascertain whether or not stable interlace can be secured. Always check interlace after servicing the receiver, particularly if the servicing involved the vertical oscillator and output sections. If interlace is not good, additional work must be done, to prevent callbacks.

Interlace may occasionally be lost for a fraction of a second because of the transmitter. If interlace is lost, and proper interlace only occurs once every three or four seconds, the fault is probably in the receiver and not the station. This can be verified by tuning to several other stations and checking the degree of interlace.

The stability of the vertical oscillator (and thus the interlace) is also affected by loading effects in the plate circuit. A change of height may affect the load on the oscillator, so it is often necessary to readjust the hold control when the height control is varied. Since the

*Author: Mandl's Television servicing.

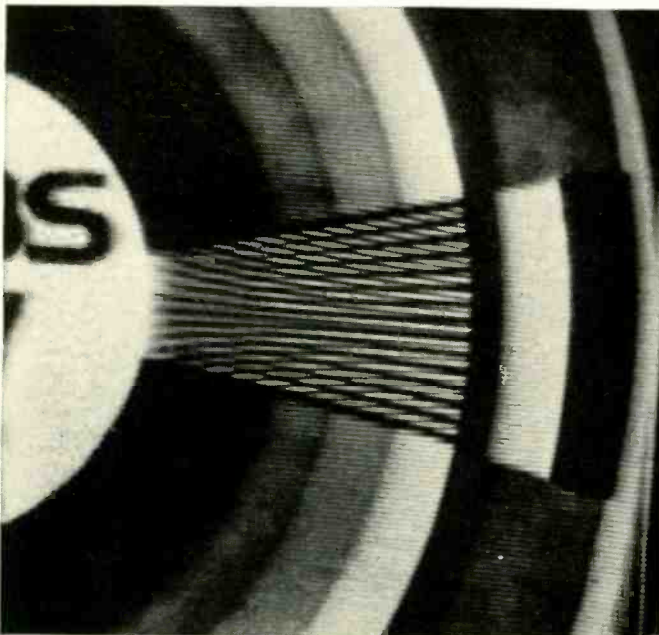

Fig. 1—Wedge shows loss of interlace.

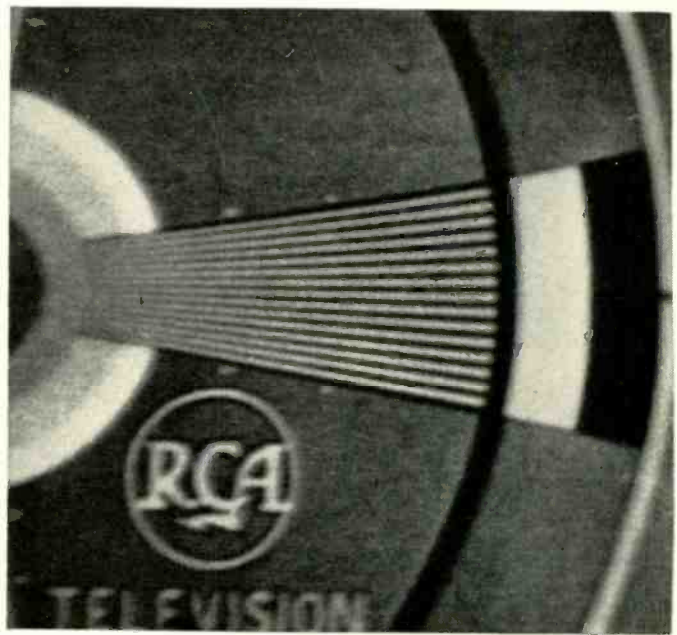

Fig. 2—Lines are properly interlaced.

height control may also affect linearity, it is usually necessary to readjust the linearity control as well. When proper linearity or synchronization cannot be obtained for the proper height adjustment, recheck the component values of resistors and capacitors in both the integrator network as well as the other circuits associated with the vertical oscillator. Since capacitor values are critical, do not use the convenient method of checking their leakage resistance with the $R \times 1$ megohm scale. It has two serious drawbacks. It does not apply a working voltage to the capacitor, and it will not ascertain an off-value capacitor. Use a capacitor checker which can subject the unit to the working voltages while the capacitance and leakage (power factor) are read.

The vertical output amplifier circuit also affects the loading on the vertical oscillator. Since the vertical oscillator is adjusted while the set is in operation, its final stability also depends on the load imposed by the vertical output circuit. A change in the characteristics of the vertical output tube alters the load on the oscillator and can affect its stability. The same holds true for a change in any of the resistors or capacitors in the vertical output amplifier. Any change in resistance which can cause an increase in current flow through the vertical output amplifier will increase the load on the oscillator and affect its performance. Thus, symptoms of vertical instability or loss of interlace call for a thorough check of the voltages on the vertical output amplifier as well as the oscillator. Try a new tube and make a check for off-value resistors and capacitors. If all such components check all right, test the vertical output amplifier transformer as well as the vertical deflection coils. This includes the damping resistors placed across the vertical deflection coils.

Another source of trouble is the coupling capacitor between the oscillator and the vertical output amplifier. Leakage here will seriously affect linearity and will usually cause foldover along the bottom of the picture. A leaky coupling capacitor will cause the grid of the vertical output tube to become positive and thus consume power. The increased current flow through the vertical output tube will cause the tube to be short-lived and the load on the vertical oscillator is increased. Instability occurs, but this can usually be corrected within the range of the vertical hold control, though interlace is usually lost.

Commercial circuits

Two primary types of vertical oscillators are the blocking oscillator and

the multivibrator. When the blocking oscillator is used (Fig. 3) troubles can occur because of a defective transformer. Shorted turns in either the primary or the secondary will cause loss of synchronization to a point where the vertical hold control can no longer compensate for the change in circuit characteristics. In such cases the transformer should be replaced, though on occasion changing the resistance in the hold control circuit can restore normal operation. While this can be done as a temporary measure, a new transformer should be installed as soon as available. If the transformer has developed a few shorted turns, it will get worse in time.

The conventional multivibrator type of vertical oscillator is shown in Fig. 4. As with the blocking oscillator, an integrator network is also used. In

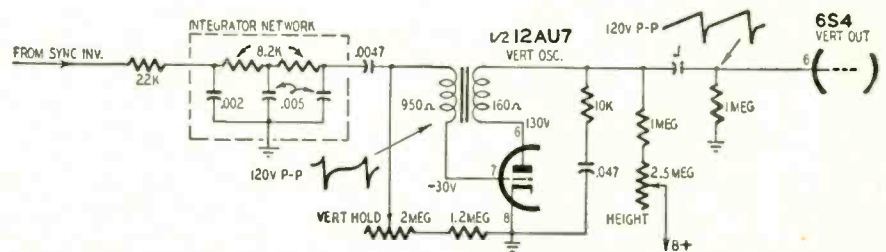

Fig. 3—Integrator network in vertical sweep circuit of Admiral chassis 20A2.

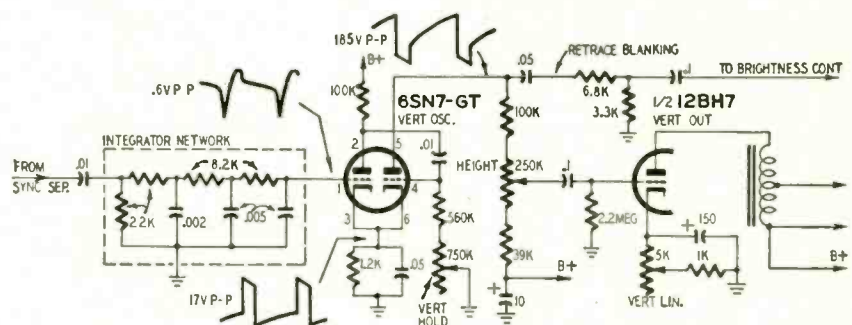

Fig. 4—Multivibrator-type oscillator used in Westinghouse chassis V-2247-1.

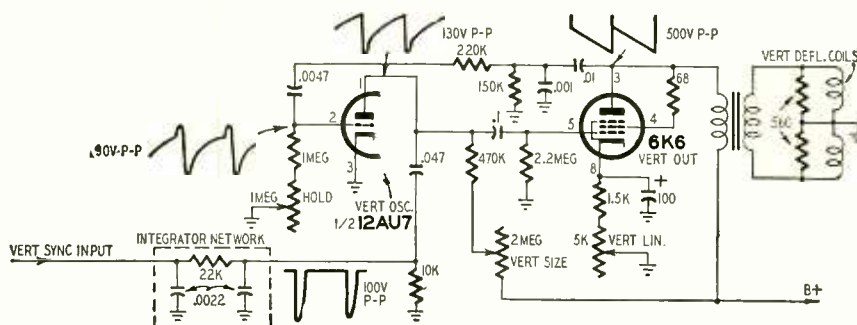

Fig. 5—Multivibrator in vertical oscillator circuit of Emerson 120182-D.

this circuit the vertical hold control is in the grid circuit of the second tube. The grid leak for the first tube of the oscillator consists of the series resistors which are part of the integrator network, plus the 22,000-ohm resistor to ground.

Since the two tubes are coupled by the common cathode, any defect in the cathode resistor or its bypass capacitor can change the frequency of the oscillator or cause it to stop oscillating.

This vertical oscillator is used in the Westinghouse chassis V-2247-1 television receivers and has several unusual features. One arrangement which differs from the conventional circuit is the height control. Normally the height control varies the anode voltage of the oscillator and thus the amplitude of the sawtooth formed as shown in Fig. 3. With the oscillator of Fig. 4, however, the height control consists of a potentiometer which selects the amount of drive signal applied to the vertical output tube.

Another unusual feature here is that the retrace blanking circuit is attached to the anode of the second oscillator tube. Normally the retrace blanking circuit is connected to the plate of the vertical output amplifier. In this circuit, defects in the brilliancy control system or in the associated retrace blanking circuit can affect the load on the vertical oscillator and cause sync instability. For this reason the series capacitors and resistors, as well as the shunt 3,300-ohm resistor should be checked.

The cathode bypass capacitor in the vertical output amplifier of Fig. 4 has a value of 150 μ f; such a large capacitance is necessary to bypass the 60-cycle sweep rate adequately. If this capacitor is defective, it can affect oscillator stability because of the change in load which results. If it decreases in value, or is replaced by one with a lower capacitance than the original, inadequate height will result. If the vertical height control is then adjusted to expand the picture vertically, it will load the vertical oscillator unduly and result in general sync instability. Therefore the vertical output amplifier must operate at peak efficiency so that the oscillator will not be overloaded.

Another type of multivibrator used in vertical oscillator circuits is shown in Fig. 5. This circuit uses the vertical output amplifier as part of the multi-

vibrator circuit. Thus, the first tube ($\frac{1}{2}$ of 12AU7) is the first tube section of the multivibrator and its output is coupled to the grid of the 6K6. The plate of the 6K6 vertical output tube is connected to the primary of the vertical output transformer, but a feedback network is also applied from the plate of the output tube to the grid of the 12AU7. This is the feedback network which sustains oscillations. The R-C constants of the networks between plates and grids are designed to reduce the effects of noise on oscillator stability.

Servicing procedures are similar to those detailed for other circuits. When instability occurs, tubes should be checked first and replaced if weak. Voltages and component part values should be also checked and replaced if off-value. Service notes for receivers also should be checked as well as the supplements thereto for any modifications of the circuit recommended by the manufacturer. In the circuits shown for Fig. 5, for instance, the resistor in series with the hold control was originally 820,000 ohms. In later productions this was changed to 1 megohm so that the hold control establishes sync

near the center portion of its range. The 1,500-ohm resistor in series with the linearity control was originally 470 ohms in the earlier models. Late models also incorporate the 68-ohm resistor shown between the screen grid and the plate of the 6K6. This minimizes parasitic oscillations and reduces the tendency of such oscillations to create noise in the audio system during an occasional (and momentary) sync loss caused by program breaks.

Test equipment

Besides standard equipment such as the oscilloscope and vacuum-tube voltmeter, a linearity pattern generator is also useful. This unit is essential to correct for poor linearity in the absence of a station pattern. The linearity generator can be one producing vertical and horizontal bars, or the dots shown in the photograph at the head of this article. Poor vertical linearity is indicated here where the dot structure at the bottom is more closely spaced than at the top. Some defocusing at the sides is also indicated. When the linearity pattern generator is used, the lack of interlace cannot be ascertained because transmitted sync is not present. After linearity adjustments are made, interlace can be checked by turning to a station.

In some receivers (such as the Raytheon models C-2401A and C-2402A series) a printed circuit is used for the integrator. In such an instance the resistors can be checked, but the capacitors will have to be checked without being able to disconnect one end. It will be difficult to measure the capacitance values accurately without special equipment. When there is any doubt, a new integrator printed-circuit strip should be inserted. END

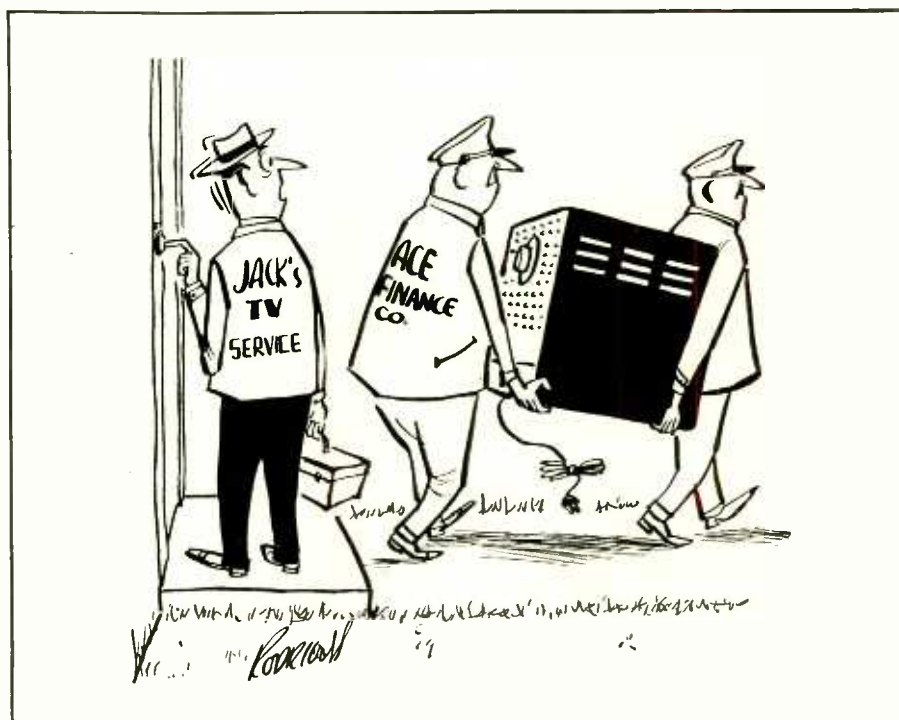

TELEVISION . . . it's a cinch

From the original "La Télévision . . . Mais c'est très simple!" Translated from the French by Fred Shunaman. All North American rights reserved. No extract may be printed without the permission of RADIO-ELECTRONICS and the author.

By E. AISBERG

Twelfth conversation, second half: More r.f. problems, from the ground up; contrast controls, mixer methods.

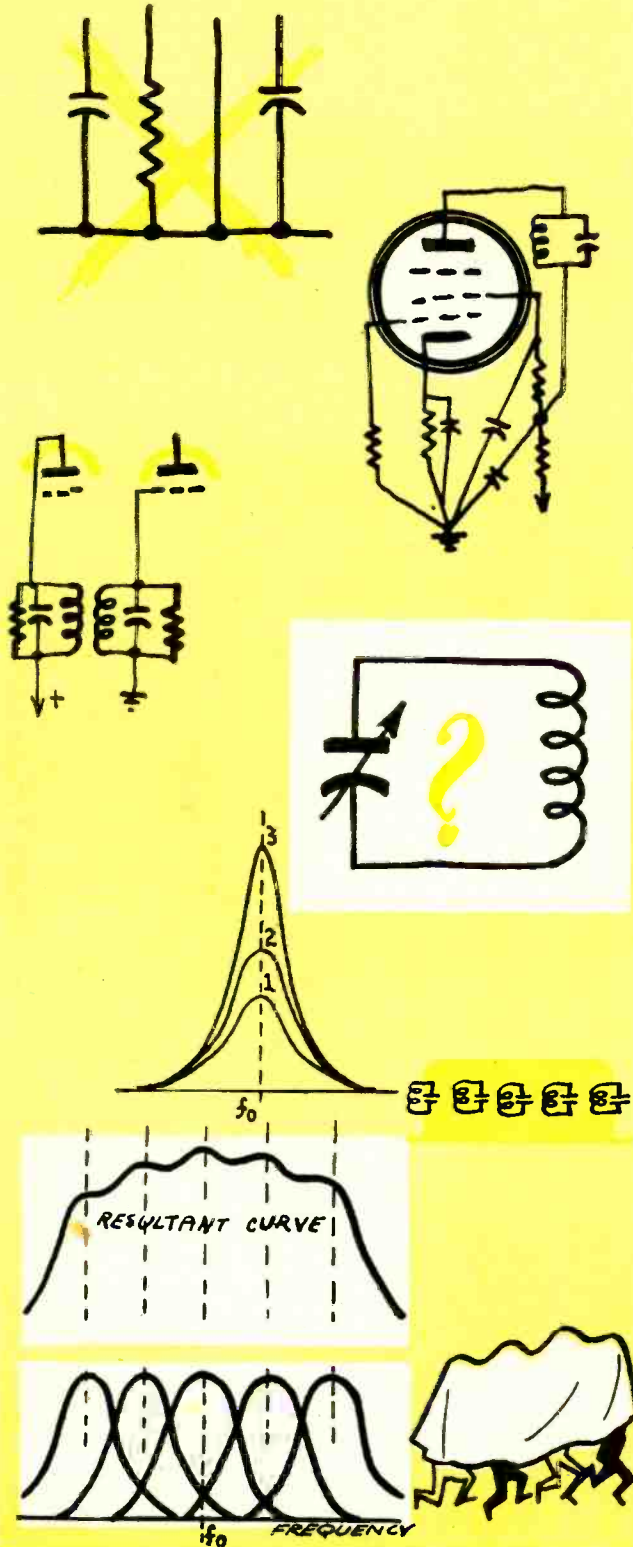

WILL—There's something new and different in your diagram. Usually all the lines in a schematic come together in neat right angles. But here you have a spray of lines coming from a single point on the chassis. Why?

KEN—You'll see more of that kind of hookup. It simply means that all the negative, or ground, connections are brought together at a single point on the chassis or ground bus. The old radio stunt of bringing ground leads to the most convenient point on the chassis is a sure way of producing oscillation (or sometimes heavy degeneration) when the frequencies begin to get high!

WILL—I see that the screen and plate are bypassed by capacitors that lead to the ground point on the chassis, and the cathode is bypassed by another capacitor across the cathode resistor. But aren't we trying to bypass plate and screen back to the cathode?

KEN—You're right. Decoupling might be a little better if the capacitors from the screen and the lower end of the plate coil were brought direct to the cathode. But it's easier to wire up a set with all these leads coming back to a common chassis point for each stage, and there doesn't seem to be much difference in practical results.

WILL—Are all televisers wired this way? I've seen plenty of TV schematics, but I don't remember ever seeing one that looked like this.

KEN—Once you understand the principle, it isn't necessary to show it in the diagram. For example, this drawing is in standard schematic style.

WILL—Yes, this looks normal. Here's the good old inductively coupled circuit with tuned primary and secondary. This kind of a circuit should help to bring up your selectivity quite a bit.

KEN—Poor Will! You still insist on thinking and talking like a good broadcast technician. But comparing TV to broadcast radio is like comparing radio to electric power circuits! You've got to change your whole outlook on life! "Bringing up the selectivity," as you put it so innocently, would be a calamity! And the worst of it is, increasing the number of tuned circuits does lead just toward that calamity. For example, look at this selectivity curve of one tuned circuit, then of two and of three in cascade. Every time you add another stage you narrow the passband, and our video signals have less and less chance to get by!

WILL—But they do get by! You're holding out on me—you have a cure for this trouble. What is it?

KEN—It's simple! You just tune each circuit to a slightly different frequency!

WILL—What? Do you mean you intentionally misalign the circuits—throw your i.f. amplifier out of adjustment?

KEN—Exactly. By selecting the frequencies of the various tuned circuits properly, you can get an over-all selectivity curve that approaches the ideal shape very closely. Of course, you pay for it in reduced gain—we still haven't found any way of getting something for nothing.

WILL—This curve of yours reminds me of the way we used to play camel when we were small kids. We'd get in a row and cover ourselves with a blanket. Our "camel" did have too many humps—I never saw anything just like it till you drew this flock of curves.

KEN—It's nice to know that a few of the experiences of your misspent youth are helping your understanding today!

Sensitivity and contrast

WILL—This may sound a little dopey—but is the gain of these TV amplifiers fixed, or do you have a gain control of some kind? I don't remember ever seeing any such controls—but I don't exactly know the meanings of all the terms on the screwdriver adjustments.

KEN—There is an adjustment all right, and it's right out on the panel—with a knob—where you can see it. It varies the gain the same way as gain controls work in radio—occasionally by varying the voltage on the screen grids, but mostly by varying the cathode bias.

WILL—And just what does a TV gain control do? Let's see—it would vary . . . Oh, of course! It's the brightness control! You said it was on the front panel . . .

KEN—But I didn't say it was the brightness control! The brightness is controlled by varying the picture tube's cathode bias, but we'll talk about that later. The gain control varies the amount of video modulation applied to the control element (grid or cathode) of that tube. When the video signals are weak . . .

WILL— . . . the brightness of the spot varies very little . . .

KEN— . . . and when the signals are strong, the spot goes through the whole gamut of brightness from dead black to intense white.

WILL—So—in the first case—you have a gray picture. In the second you have a picture with sharp blacks and whites. It's just like printing a photo negative on a soft type and then on a contrast type of photographic printing paper.

KEN—Exactly! And you have named the gain control without realizing it! It's the one you call "contrast" of course.

WILL—I guessed it! Now, does it control the r.f. tubes or the i.f. tubes?

KEN—It has been used on both—and even on the mixer tube—but now it generally controls the cathode bias of the video tubes, and the i.f. and r.f. stages have automatic gain control.

One or two tubes

WILL—You spoke of a mixer tube. I notice that TV circuits generally show an oscillator and a mixer, instead of the one converter tube we always have in radio. Why?

KEN—There are several advantages. You would get very much less gain with a converter tube at TV frequencies than on the broadcast band. It's better to use a pentode with a lot of gain and have a separate local oscillator. But both the converter tube and the pentode mixer have a bad fault—noise. The more elements you have in a tube, the noisier it is. So the majority of front ends now have a triode mixer and a triode oscillator—usually in the same tube—preceded by a cascode r.f. stage.

Sound without picture and picture without sound

WILL—But I see only one output lead here. We know there are two i.f.'s, sound and pix. Do they both go through the same i.f. amplifier?

KEN—In most cases, yes. That's what happens in all sets that use the *intercarrier* system. The *split-sound* receiver does have a separate sound i.f. amplifier, and another little coil tuned to the sound i.f. is placed in the output circuit of the tuner-converter to pick off the sound intermediate frequency. Perhaps I should have said "take off" the sound, because the coil is called a sound take-off. We'll draw it in dotted lines. Then there are a few sets that have one or two composite i.f. stages like an intercarrier receiver, then send the sound i.f. to a separate amplifier.

WILL—This begins to get complicated. Suppose we lay off for another day or so, till I get time to digest this.

(TO BE CONTINUED)

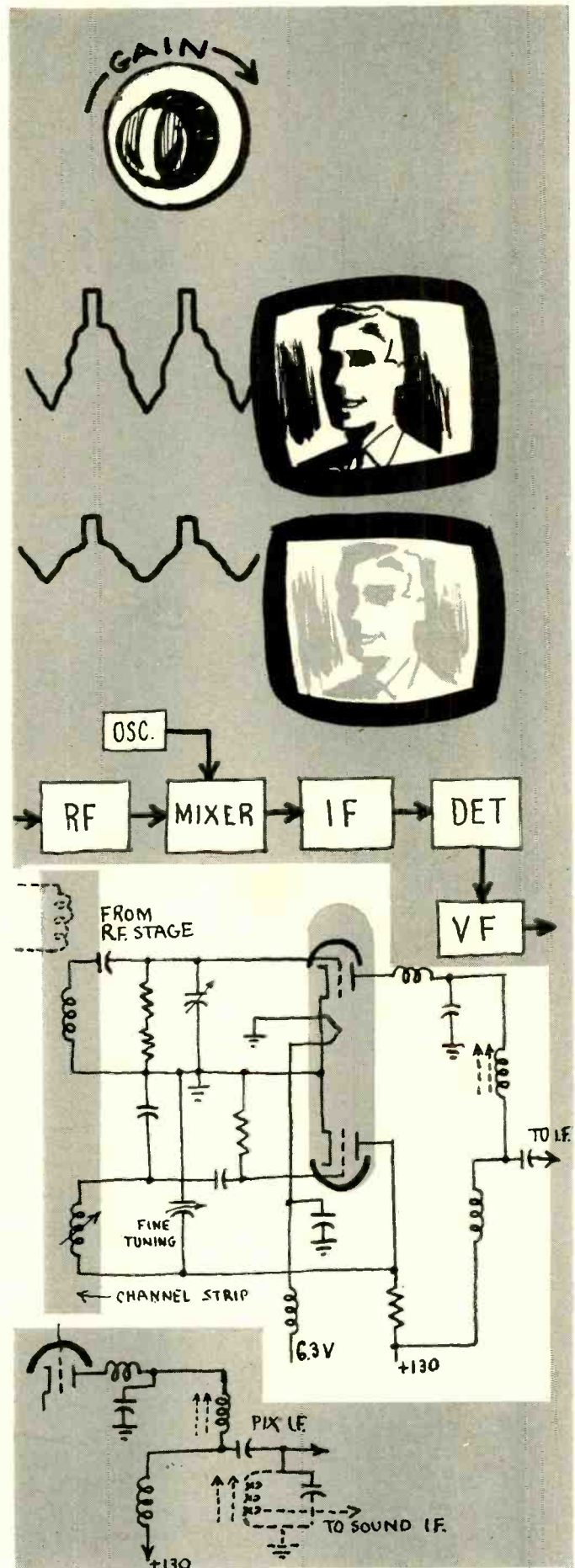

COLOR TV CIRCUITS

*Part IV—Demodulators and matrix circuits.
The authors begin with a simplified system which is not difficult to understand*

By KEN KLEIDON and PHIL STEINBERG*

THE color oscillator and associated control circuits were covered in our previous article. We stated that the color burst signal and oscillator control circuits synchronize the color oscillator with the station, and the color oscillator applies two signals 90° out of phase to the demodulators. We also stated that the oscillator and control circuits were required in a color receiver regardless of the type of picture tube. The demodulators and matrix circuits fall into the same general category in that these circuits may be found in a color receiver using either the dot type of RCA or CBS, or the strip type (Lawrence) picture tube. However, due to the circuit simplifications possible using the Lawrence tube we will deal only with the demodulators and matrix circuits for the RCA or CBS dot type picture tube and cover the circuitry for the Lawrence strip type tube in a later article.

The oscillator buffer amplifier shown in Fig. 1 receives the signal from the color oscillator, amplifies this signal and, due to quadrature transformer T1 in the plate circuit, applies two signals—90° out of phase—to the demodulators. The quadrature transformer has a tuned primary and tuned secondary.

*Raytheon Manufacturing Company, Television and Radio Division

When both primary and secondary are tuned to resonance the secondary output is 90° out of phase with respect to that of the primary. Therefore, the two signals applied to the demodulators will be 90° out of phase. Various methods may be employed in color receivers to couple the two oscillator signals to the demodulators, but in all methods there will be a 90° phase difference between the two signals. (The two oscillator signals are required for demodulation because the color information is contained in two signals modulated 90° out of phase at the transmitter.)

The two basic systems of demodulation in color receivers are the I-Q, and the B-Y R-Y or color-difference demodulation. One difference between the two systems involves the difference in phase between the two oscillator output signals and the incoming color-burst signal, the other concerns the color-signal frequency bandpass. The phase difference between the two systems is shown in Fig. 2. The I-Q system is merely rotated 33° with respect to the R-Y B-Y system. This rotation changes the relative amplitude of the two signals. However the total color signal consisting of the vector sum of either the R-Y and B-Y signals or the I plus the Q signal remains the same. Be-

cause of this the original red, blue, and green signals which were transmitted may be reconstructed by use of the proper matrix circuit. The relation between the two systems are embodied in the following two matrix equations:

1. $R - Y = 0.95I + 0.63Q$
2. $B - Y = -1.10I + 1.70Q$

The first equation states that an R-Y signal may be obtained by adding 95% of the output from an I demodulator and 63% of the output from a Q demodulator. The second equation states that a B-Y signal may be obtained by adding a negative 110% of an I demodulator output (180° out of phase with a positive Q signal) and 170% of the Q demodulator output.

The I and Q system has the advantage of providing extended color frequency response up to 1.2 mc, whereas the R-Y B-Y system is limited to 600 kc. However, the I-Q system requires a greater number of stages and may prove difficult to service due to its complexity. This article will deal only with R-Y B-Y demodulator system. We will cover the I-Q system in our next article.

As shown in Fig. 3, the color signal from the bandpass amplifier is applied to each demodulator control grid; and the two signals from the color oscillator, which are 90° out of phase, are

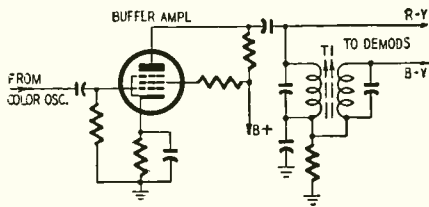

Fig. 1—Oscillator buffer amplifier.



Fig. 2—Diagram shows demodulation systems—right I-Q, at left, B-Y R-Y.

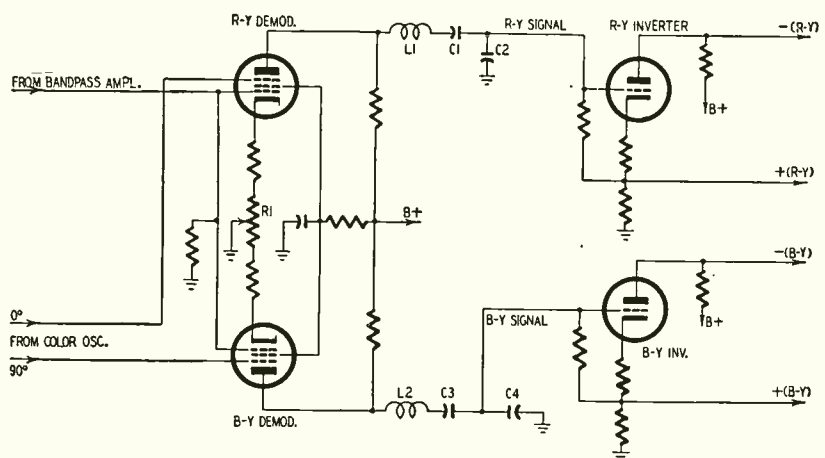

Fig. 3—Diagram shows signals fed to demodulator to obtain R-Y B-Y output.

applied to the suppressor grids. The R - Y and B - Y signals are obtained at the output.

A demodulator is similar in operation to the first detector in a superheterodyne radio receiver. The local-oscillator signal is beat or heterodyned with the incoming r.f. signal and the difference frequency is selected in the output.

Consider the color signal equivalent to the incoming r.f. signal, the color oscillator signal equivalent to the local



Fig. 4—Response of low-pass filters.

oscillator, and the R - Y and B - Y signals equivalent to the video information amplitude-modulating a difference or intermediate frequency. Since the oscillator (3.58 mc) signal is exactly at the same frequency as the color sub-carrier signal the difference or i.f. will be zero. Therefore, the two original video color-difference signals are recovered directly at a phase difference set by the reference 3.58 mc to the demodulator suppressors. This phase difference between the two signals is 90° if the quadrature transformer—or other phase-shifting circuit—is tuned properly.

A low-pass filter consisting of L1-C1-C2 and L2-C3-C4 is placed in the plate circuit of the demodulators to prevent noise or any of the 3.58-mc oscillator and color subcarrier signal from appearing in the output and causing interference. The response of the low-pass filters is shown in Fig. 4.

Color-balance control R1 in the cathode circuit of the demodulators, is also shown in Fig. 3. This control compensates for the difference in gain of the two demodulator tubes and the different amplitudes of the R - Y and B - Y signals. The R - Y signal is trans-

mitted at 1.78 times the amplitude of B - Y signal, and therefore the design of the demodulators must provide for greater amplification for the B - Y signal. The color balance control is adjusted for equal amplitudes of the signals in the output of the demodulators.

The demodulated color signals R - Y and B - Y may be passed through an inverter stage to provide the proper phase relationships for application to the matrix circuits. As in any phase inverter, there is a 180° phase difference between the cathode and plate, and therefore negative and positive R - Y and B - Y color signals are available for matrixing (Fig. 3). In some sets—by proper phasing of the 3.58-mc reference signal from the color oscillator—minus R - Y or minus B - Y signals are obtained directly from the demodulators, which are then designated as a minus R - Y demodulator or a minus B - Y demodulator.

A matrix circuit simply mixes two signals together to obtain a desired result. Fig. 5 shows the Y or luminance signal developed across R1 and R3, while the R - Y signal from the R - Y demodulator and inverter is developed across R2 and R3. Since both signals are developed across R3 the Y signal is canceled, leaving only the red signal. A plus Y and a negative Y signal result in zero Y signal, and the red signal, identical to the red signal from the red camera tube at the station, is obtained. The values of R1 and R2 are critical, and are therefore 5% in tolerance. The resistance ratios are predetermined from the color equations and signal levels available, as the proper amplitude of the plus Y signal must be developed across R3 to cancel the negative Y signal.

From the color equations, it can be shown that $G - Y = -0.508 (R - Y) - 0.187 (B - Y)$. This relationship is used in the green-signal matrix circuit, as shown in Fig. 5. Minus R - Y and minus B - Y signals are fed to the green-matrix resistors from their respective inverters. By attenuating the signals in accordance with the equa-

tion, the G - Y signal is formed across R4, which when added to the plus Y signal fed-in from the monochrome channel, gives $G - Y + Y = G$.

Another matrix system that may be used employs the equation, $G = 1.7Y - 0.5R - 0.17B$.

This matrix operates by taking the indicated proportions of the final red and blue color signals (not R - Y and B - Y) and adding 1.7 times the plus Y signal to give the green signal, as shown in Fig. 5 (broken lines).

The red, green, and blue signals from the output of the matrix circuit are equivalent to the signals from the color camera and are amplified and applied to the picture tube.

Other methods of matrixing may be employed in color receivers. However, the same principles apply. Vacuum tubes may be used in place of resistors—even the picture tube may be used. A three-gun color picture tube is shown in Fig. 6. Signals R - Y, G - Y, and B - Y are applied to the red, green, and blue cathodes, respectively. A negative Y signal is applied to the control grids which are tied together. Applying a negative Y signal to the grid is equivalent to applying a positive Y signal to the cathode. The G - Y signal is obtained, as before, by matrixing a ratio approximately -51% R - Y with -19% B - Y. The signals then add in the picture tube giving $R - Y + Y = R$, $B - Y + Y = B$ and $G - Y + Y = G$.

In trouble-shooting a color-difference demodulation type of receiver, the face of the picture tube will usually give the quickest isolation of troubles. If red or blue detail is missing while a normal-looking black-and-white picture is obtained for monochrome transmission, the R - Y demodulator may be causing the loss of red detail while the B - Y demodulator may be at fault for lack of blue detail. If it is not possible to secure proper colors by replacing the demodulator tubes, it may be because a matrix resistor is open or shorted. This may be checked by resistance measurements.

We cannot too strongly emphasize that before checking the color circuits, reception should be first checked on black-and-white transmission so that all circuits common to the black-and-white and color channels may be eliminated.

The next article will deal with the I-Q system and with video output circuits. END

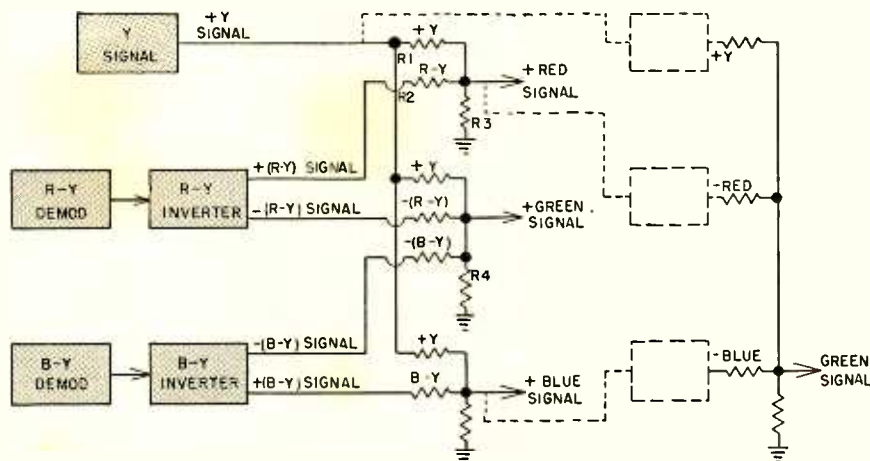

Fig. 5—Diagram shows two matrix systems—either can produce the green signal.

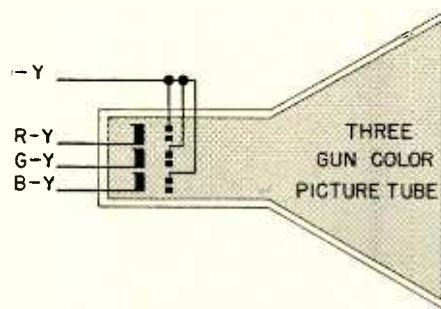

Fig. 6—A 3-gun color picture tube.

Tracking Down HORIZONTAL INSTABILITY

By CYRUS GLICKSTEIN

PART II—Tracing sync pulses; probable points of trouble

In signal tracing, the manufacturer's service data is almost as important as the technician's test equipment.

Compare the waveforms on the scope with those shown by the manufacturer. Important points to look for are:

1. Full-amplitude sync pulses above the video level in the video system output (video detector and amplifier) (Fig. 1-a): If the sync pulses are compressed at any check point in this part

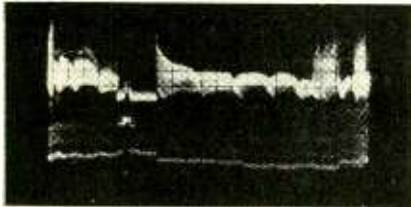

Fig. 1-a—Normal signal in video output.

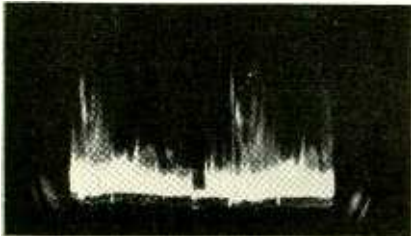

Fig. 1-b—Defective video signal. The sync pulses are extremely compressed.



Fig. 2—Signal with 60-cycle hum pickup.



Fig. 3-a—A normal sync waveform.

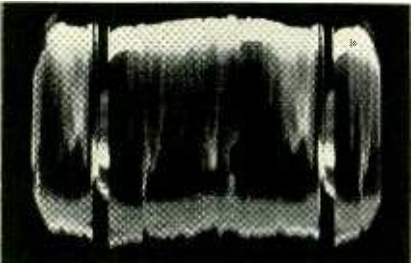

Photos courtesy G-E Techni-talk
Fig. 3-b—Sync pulse output showing some video information remaining.

of the video system (Fig. 1-b) check for the cause in the preceding stage.

2. Sixty-cycle hum pickup in the signal: This will look on the scope like Fig. 2. Check for hum on the scope baseline (see that the baseline is straight) before connecting the leads to the TV receiver. When making waveform checks, the scope leads, *including the ground lead*, must be connected properly; a defective connection may result in a distorted waveform.

3. Ripple in the B plus line: If hum is visible in the signal, find out if it originates in the B supply. Only a small amount should be visible in the B plus line. A large ripple indicates a defect in the low-voltage supply.

4. Correct sync-circuit operation: The output from the sync section should consist of well-clipped sync pulses (Fig. 3-a). Sync-section output that contains video information (Fig. 3-b) makes synchronization unstable.

5. Trouble in the video detector, video amplifier, sync, a.f.c., and horizontal oscillator stages: These can be spotted by a lower-than-normal amplitude or a distorted waveform.

When servicing new or unfamiliar models, it is worth while to check the manufacturer's field service modifications, to find out whether the fault may be common in a given model. When manufacturers receive reports of recurrent troubles in a new model, they usually recommend circuit modifications to eliminate the fault. In receivers that have developed horizontal instability because of initial design values, the most common field modifications include: Additional filtering across the a.g.c. line to reduce ripple; change of resistor values in the a.g.c. voltage divider to increase a.g.c. output voltage; change of capacitor type in the horizontal lock circuit (to a silver mica or a zero temperature coefficient ceramic); change of component values in the video amplifier, sync circuit, horizontal a.f.c., or horizontal sweep circuit; and miscellaneous changes, such as relocation of parts, change in lead dress.

Causes of instability

The following list of some common causes of horizontal instability is based on various manufacturers' field service reports. The suggested modifications do not necessarily hold true for all models.

Video section

1. Distortion, horizontal bending, or tearing in strong signal areas; erratic horizontal hold: Weak or gassy r.f. or video i.f. tube; insufficient a.g.c. voltage.
2. Unstable horizontal or vertical sync:

Some 6CB6 tubes do not have a great enough linear amplification range. This results in limiting, compressed sync signals, and poor vertical or horizontal sync operation. The most critical stage in this respect is the last video i.f. stage. Try several tubes. Unsatisfactory tubes should not be discarded, since they are usable in the r.f. or sound i.f. stages.

3. Horizontal jitter and smear caused by overload: Adjust a.g.c. control; connect attenuator network to antenna terminals to reduce signal input; change value of load resistor of first video amplifier from 2,200 ohms to 3,300 (1 watt) and cathode bypass capacitor of second video amplifier from 390 to 180 μf .
4. Picture pulling due to hum pickup in a.g.c. bus or a.g.c. amplifier tube: If a.g.c. tube change does not eliminate pulling, place 0.5- μf paper capacitor (if keyed a.g.c. is used, 4 μf) from a.g.c. bus to ground.

Sync section

1. Bend at top of picture at low contrast levels: Check value of plate load resistor in sync separator-clipper stage; replace if resistor has increased in value.
2. Hook at top of picture: Change .01- μf coupling capacitor to grid of first sync clipper to .05 or 0.1 μf .
3. Horizontal bend: Leakage between filament and other elements in 12AU7 sync separator tube.

Horizontal a.f.c. circuit

1. Horizontal jitter or touchy sync: Defective horizontal frequency coil; leaky .05- μf feedback coupling capacitor from one side of width coil to phase detector; change of value or defect in components.

Horizontal sweep section

1. Horizontal pulling to the left, top of picture only: Improper adjustment of horizontal hold or defective horizontal output tube.
2. Picture jumps, tears horizontally to the right: Defective horizontal output tube; defective 0.5- μf capacitor from damper tube to horizontal deflection coils.
3. Unstable sync: Check horizontal oscillator and sync amplifier tubes; check horizontal oscillator plate voltage.
4. Instability and oscillation in the horizontal sweep circuit: Insert parasitic resistor in grid circuit of horizontal output tube.
5. Horizontal sync instability and dark irregular patches on picture: Failure of capacitor across width coil in output circuit (2,000-volt rating). Internal arcing is difficult to detect. Replace mica with ceramic capacitor.
6. Intermittent horizontal hold: Check hold control, it may be worn. **END**

TV ANTENNA REPAIRS

By I. J. SOBEL

THERE is one link in the television receiver system about which very little has been written from the point of view of maintenance and repair—the antenna. TV antennas exposed to the elements for 3 months or more frequently develop difficulties that require a special trouble-shooting procedure. This is just as important as correct servicing of the chassis itself.

Symptoms of antenna trouble

Picture defects are often misinterpreted as receiver difficulties when in reality the trouble is in the antenna system. For example, if several channels are received perfectly while others are badly smeared, the tendency is to suspect the front end of the receiver. But the trouble in such cases may often be tracked down to a break in one side of the transmission line. Reflections from the break produce strong standing waves in the transmission line at the frequencies of the poorly received channels. In trouble-shooting such a job a simple d.c. continuity check of the transmission line can save a lot of time wasted on the chassis.

Any reception difficulties involving variation from channel to channel should immediately throw suspicion on the antenna system. To determine definitely whether the trouble lies in the antenna or in the receiver, connect another receiver—known to be in good condition—to the same antenna leads. Several service organizations keep portable receivers for this purpose. Such receivers may also be used as temporary replacements for customers' sets which have to be held in the shop.

Another test to isolate antenna system difficulties is to use a substitute roof antenna—a simple folded dipole, made of 300-ohm ribbon and cut to the wavelength of the troublesome channel.

Troubles in the antenna

Three main categories cover antenna troubles: First, we have poor or intermittent electrical connections to the dipole (stacked arrays have more connections and therefore bear more careful checking). Second, bent or broken active or parasitic elements may change the vertical and azimuth pickup patterns and cause weak signal pickup, ghosts, and a lowering of the signal-to-noise ratio. Third, changes in physical orientation may create symptoms similar to those associated with broken elements.

To replace the transmission line connections to the antenna terminal block, remove the antenna and mast from the mounting bracket and lay it down on a flat surface. Place the reflector on the ground or roof, and hold the mast firmly between the legs, with the mast base on the ground.

(If the antenna has forward-pointing elements as in double vees and some conicals, it may be better to remove or loosen the elements so the boom rests solidly on the roof or other flat surface. Some antennas would be damaged if bent as in Fig. 1.—*Editor*)

Using a No. 21 high-speed bit, cut a hole in each half of the terminal block which holds the active antenna rods in place (Fig. 1). Tap the holes with a 10-24 tap (Fig. 2). Then solder the newly cut and stripped lead-in wires to closed lugs, and connect the lugs to the antenna terminals with new 10-24 bolts. File clean any rust deposits around the holes and complete the job by taping the connections.

Bent parasitic elements can often be straightened by merely applying a little controlled pressure with the bare hands. Rods that have been snapped off due to wind or ice should be replaced with new elements.

A shift of antenna orientation is not too likely to occur, but it does happen with strong winds or poor installations. The pickup patterns of most broadband antennas have sharply defined lobes on some channels. This can cause an antenna which has been rotated only a few degrees to have very inferior pickup on one or two channels, although it operates very well on all others. The condition can be corrected by watching the receiver in operation on the offending channel, and turning the antenna mast in the mounting bracket until the strongest ghost-free reception is obtained. If the location is in a weak signal area a signal-strength meter may be needed to find the best orientation.

Transmission line troubles

Unstable input to the TV receiver, and poor reception on one or more channels, are the most common symptoms of transmission line trouble. They are both tackled by making a d.c. continuity check.

Remove the antenna leads from the receiver antenna terminals and connect the ohmmeter, set on low ohms, across the leads. If the antenna is of the folded dipole type a reading should ap-



Fig. 1—Drilling in terminal block.

pear. (This reading should be about five ohms for a moderately long run.) If the antenna is of the simple dipole type a shorting clip must first be connected across the antenna rods. Sometimes a resistor of 100,000 ohms or so is installed permanently across the terminals of a simple dipole antenna during the original installation to create a return path for just such a continuity check. This system is not fool-proof, however, because a break in the transmission line can introduce a moderately high series resistance which will not be detected with the ohmmeter set to read 100,000 ohms. For example, a transmission line break which produces a series resistance of 2,000 ohms—a value which might result from dust and soot settling into the break and furnishing a poor conducting path across the broken ends—would not show up when measured in series with 100,000 ohms.

If no reading is obtained when checking with the ohmmeter, the break may be located by producing temporary shorts across the transmission line at various points. This is best accomplished by carefully skinning the line and connecting a clip lead across the bare wires. Insert the temporary shorts at points on the line progressively closer to the receiver until the ohmmeter shows continuity. It is then known that the break exists between the point of continuity and the point checked immediately before.

After the break is located a decision must be made as to just how much of the line to replace. In making this decision it is important to keep the number of splices to a minimum. It is better to replace a few more feet than to make an additional splice.

The following method of splicing ribbon line, which minimizes impedance discontinuities and the attendant reflections and standing waves, is recommended:



Fig. 2—Tapping the drilled hole.

1. Cut and skin the polyethylene insulation, leaving the edge wires bare.
2. Twist the wires so they protrude sideways, as shown in Fig. 3.
3. Solder the two twisted wires (rapidly so as not to melt the insulation). Cut off the excess wire, leaving about 1/4 inch projecting on each side. Fold the wires back against the body of the line, in opposite directions from each other.

4. Tape securely for mechanical strength and weather protection. Install stand-off insulators on each side of the splice to take up mechanical strain.

Careful examination of the transmission line at critical points will indicate where the insulation is badly worn and where a new break is likely to occur. When the transmission lead passes obstructions such as TV antenna masts, beams, concrete ledges, window frames, etc., it should be taped for additional protection. Where the line makes sharp bends, it should be given plenty of slack. This is especially important near the antenna mast where slack is needed for antenna sway under strong winds.

A frequent cause of trouble is poor contact between the transmission line terminals and the antenna. In the course of checking the antenna installation it is a good idea to clean the contacts—soldering if necessary. This done, cover the connections with a

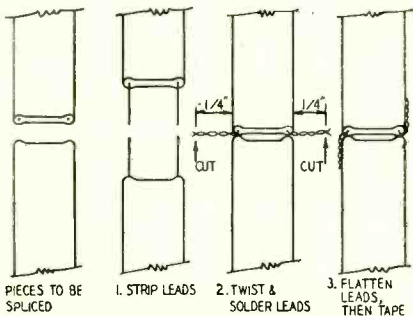

Fig. 3—Splicing 300-ohm transmission line for minimum change in impedance.

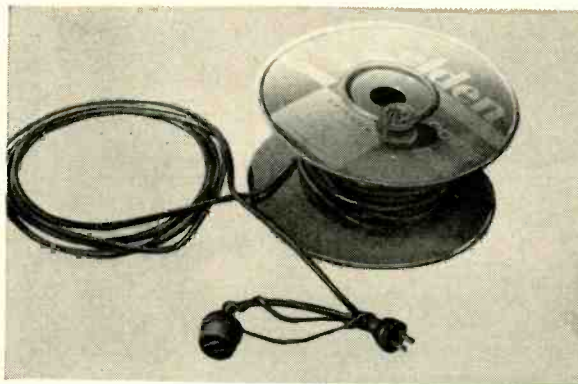
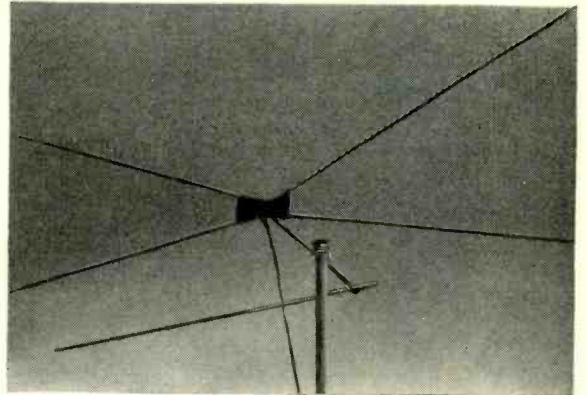

Fig. 4—Mounting a.c. cable on discarded reel makes a neat convenient tool.

Antenna with part of reflector missing.



plastic spray. In some areas where the soot in the air is found to be corrosive, the transmission line should be periodically wiped clean.

Mast work

Mechanical damage to the mast and mounting bracket is obvious on sight. The mast will probably be very rusty if it has been up any length of time. Rust is hardly a basis for replacement, however, because a new antenna will look about the same after it has been up several months in rainy weather. The antenna installation must be tested mechanically, by shaking it so as to simulate the effect of wind. While this is done the transmission line should be watched to see if it gets taut when the mast sways. Any movement of the bracket indicates that the masonry bolts need replacing. This should be done by drilling entirely new holes and inserting new bolts. Old holes have weak sides and are generally enlarged so that new bolts in the old holes will fare no better than the old bolts. In the case of chimney mounts, renewal is almost always in order since the comparatively thin material from which they are made rusts out easily.

Special tools and methods

During the course of several years' work in the field, I have devised certain tools which are especially adapted for simplifying the antenna repair job.

The first of these is a hundred-foot reel of heavy-duty rubber-covered a.c. wire for feeding a.c. power to the roof for soldering and drilling, for a roof-to-set telephone circuit, and for hoisting a tool box or parts to the roof.

Take a large empty reel, such as the one used for 1,000-foot Belden wire spools and cut a hole in its side for a

female a.c. rubber receptacle to fit snugly. Connect the inside end of the spool's wire to this receptacle and hook up the free end to a male plug and a parallel female receptacle, as shown in Fig. 4.

The second "gadget" is a small battery box for supplying power to carbon telephones. A metal box 2 x 3 x 4 inches can be used. Mount a 4 1/2-volt A bat-

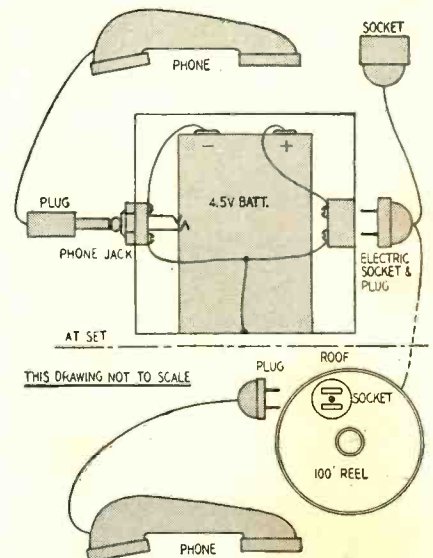
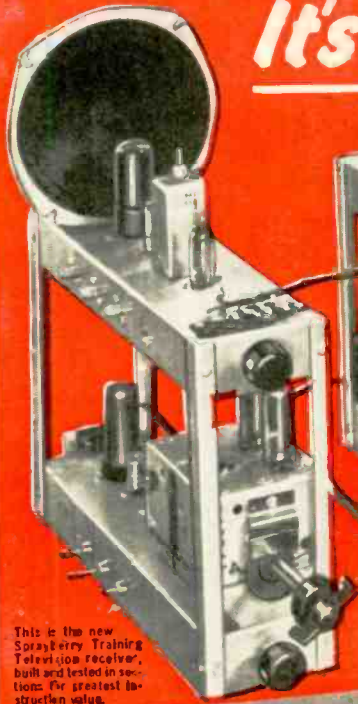

Fig. 5—Carbon-telephone battery box.

tery in the box with an open circuit phone jacks and female receptacle on opposite sides. The proper fittings are then mounted on the telephone hand sets, as shown in Fig. 5.

The service technician will find that the procedures outlined can save time and effort, and will create customer confidence and good will. END

**It's New! 3 Years in Development
-NOW READY FOR YOU!**



This is the new Sprayberry Training Television receiver, built and tested in sections for greatest instructional value.

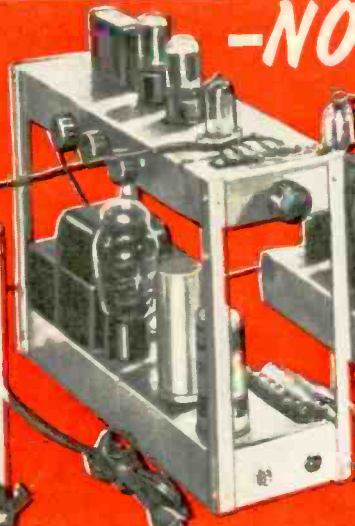

These photos show only a small part of the training equipment I send my students.

You build the new Sprayberry Test Set - 30-range Volt-Ohm-Millimeter readings plus out-of-balance and condenser and resistor substitution selector.

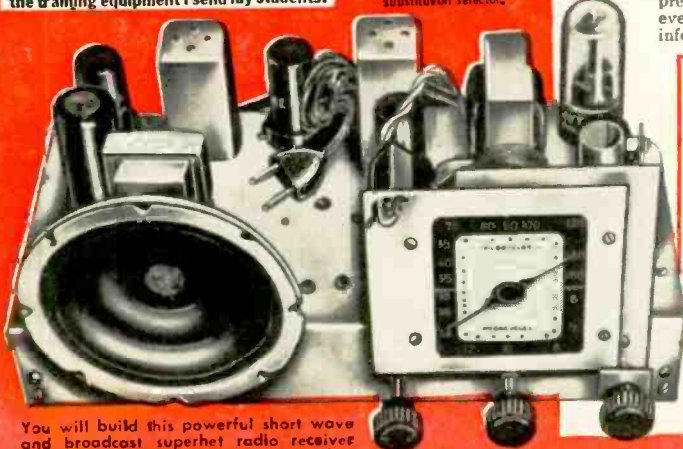

You will build this powerful short wave and broadcast superhet radio receiver for valuable shop instruction practice.

New Equipment! New Lessons! Enlarged Course!
SPRAYBERRY PRACTICAL TRAINING IN
RADIO-TELEVISION
3 NO OBLIGATION TRAINING PLANS



Frank L. Sprayberry
President, Sprayberry
Academy of Radio

You have NO MONTHLY PAYMENT CONTRACT to sign ... pay for this outstanding training as you learn!

The complete facts are so big and so important to any man seeking training in Radio-Television that I urge you to mail the coupon below at once for my big all-new 56 page **FREE CATALOG** and **FREE Sample Lesson**. Get the full story of this remarkable new and up-to-the-second Training Plan. You'll read about my **3 NO OBLIGATION PLANS** or "packaged unit" instruction for both beginners and the experienced man. You'll learn how I can now prepare you in as little as **10 MONTHS** to take your place in this fast moving big money industry as a Trained Radio-Television Technician. You'll see that you take no risk in enrolling for my Training because you **DO NOT SIGN A BINDING TIME PAYMENT CONTRACT**. I have been training successful Radio-TV technicians for 22 years . . . I can prepare you, too, to get into your own profitable Service Shop or a good paying job, even if you have no knowledge of Radio-Television. Mail the coupon . . . I rush full information **FREE** and without obligation. (No salesman will call.)

NEWEST DEVELOPMENTS

Your training covers **U H F, Color Television, F M, Oscilloscope Servicing, High Fidelity Sound and Transistors.**

PRACTICE AND TRAIN AT HOME WITH 25 NEW KITS OF EQUIPMENT

You get valuable practical experience in construction, testing and shop practice. You build a powerful 2 band superhet radio, the all-new 18 range Sprayberry multimeter, the new Sprayberry Training Television receiver, signal generator, signal tracer and many other projects. All equipment is yours to use and keep . . . and you have practically everything needed to set up a Radio-Television Service Shop.

All your training is **IN YOUR HOME** in spare hours. Keep on with your present job and income while learning. I help you earn extra spare time money while you learn. If you expect to be in the armed forces later, there is no better preparation than practical Sprayberry Radio-Television training. Rush coupon below for all the facts—**FREE!**

SPRAYBERRY ACADEMY OF RADIO
111 NORTH CANAL STREET, DEPT. 20-N, CHICAGO 6, ILLINOIS

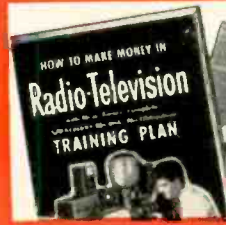

FREE CATALOG AND SAMPLE LESSON

Rush coupon for my catalog "How to Make Money in Radio-Television". **PLUS** an actual sample Sprayberry Lesson without obligation—**ALL FREE**. Mail coupon **NOW!**

SPRAYBERRY ACADEMY OF RADIO MAIL THIS COUPON FOR **FREE** Dept. 20-N, 111 N. Canal St., Chicago 6, Ill. **FACTS AND SAMPLE LESSON**

Please rush all information on your **ALL-NEW** Radio-Television Training Plan. I understand this does not obligate me and that no salesman will call upon me. Include New Catalog and Sample Lesson **FREE**.

Name _____ Age _____
 Address _____
 City _____ Zone _____ State _____

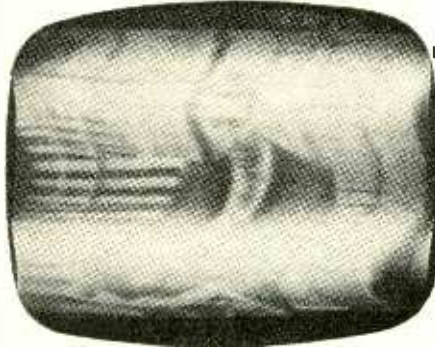
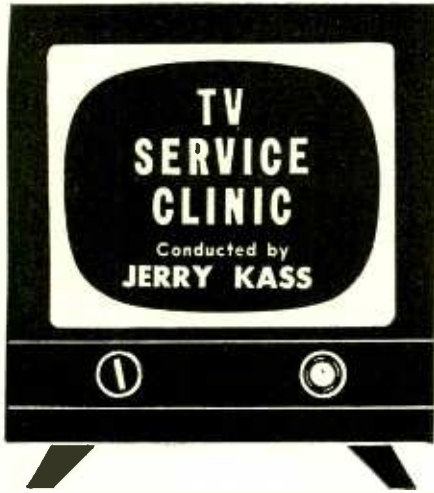

Fig. 1—Picture with 120-cycle hum.

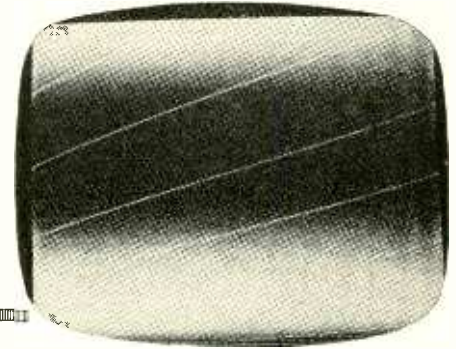

Fig. 2—A 60-cycle hum originating between sync take-off and C-R tube.

FEW defects in a TV receiver can be spotted as quickly as hum. Despite this, pin-pointing the faulty component or circuit is often very time-consuming. Because hum is not usually analyzed—most service technicians check one circuit after another at random—a great deal of effort is wasted. Fortunately, hum originating in different circuits has varying characteristics. In this discussion we will assume a TV receiver with the usual 60-cycle full-wave power supply.

Hum is the effect of either the 60-cycle heater supply or the 120-cycle low-voltage supply. Its effects appear on the screen by way of the deflection circuits, picture circuits, or both. When hum affects the raster, either as a horizontal bar (variation in brightness) or as a ripple along the edges, it will similarly affect the picture. However, it can appear in the picture without affecting the raster.

The first step in pin-pointing the source of hum is to determine whether it is 60 or 120 cycles. If there is one cycle of variation in brightness or edge curvature or a combination of both, it indicates 60-cycle hum — invariably caused by heater-to-cathode leakage. This effect can usually be obtained by connecting a resistor (100,000 ohms or larger) between the cathode of a tube and the ungrounded side of its filament supply.

Two cycles of variation in brightness or edge curvature or a combination of both indicates 120-cycle hum—invariably caused by a defective component, most often a capacitor, in the low-voltage power supply circuit.

120-cycle hum

The most common cause of 120-cycle hum is an open filter capacitor in the B plus or B minus supply, creating high 120-cycle fluctuations. If this occurs directly at the main power-supply filter, video and audio circuits could be affected. If it occurs only at one of the many B-supply paths, the ripple effect may be limited to some particular circuit.

If hum is caused by a defect in the B supply to the video amplifier, two hum bars will appear on the screen; they will appear on the raster, with or without a picture. See Fig. 1. If the hum is caused by a defect in the B supply to the r.f. or i.f. amplifiers, the bars will disappear when the last video i.f. amplifier tube is removed from its socket.

When the raster displays a 2-cycle change in width or height, appearing as modulation along the sides or top and bottom, it indicates the trouble lies in the B supply to the horizontal or vertical (rare) amplifiers. This affects the raster, and will appear with or without the picture.

Two cycles of horizontal S-shape variation—in the picture only—indicates trouble with the horizontal sync phasing. If the trouble is caused by the B supply to the horizontal a.f.c. or sync circuits, no bars will appear since hum will not usually reach the picture-tube grid. If hum is anywhere in the signal path, bars also will appear. (Fig. 1)

The best check for 120-cycle hum is to connect an electrolytic capacitor across each of the suspected capacitors and observe which one of them clears up the trouble.

60-cycle hum

Although there is a 60-cycle field around the power transformer and

rectifier tube, it rarely causes any trouble. Virtually all 60-cycle hum can be traced to heater-cathode leakage in some tube where the 60-cycle current flows through the cathode resistor and modulates the signal. The greatest danger lies in high-impedance cathode circuits such as discriminators or second detectors. Thus, a tube with a slight heater-to-cathode leakage and causing hum may often be exchanged with a good tube from a low-impedance circuit. This will eliminate the hum, and the rejected tube will give no difficulty in many positions in the average TV receiver.

When one hum bar appears, remove the last i.f. amplifier tube. If the bar remains, it indicates a heater-cathode leakage in the video amplifier (Fig. 2). Since the video amplifier can pass a 60-cycle signal, heater-cathode leakage of any tube in the video amplifier will produce a hum bar regardless of whether or not the picture appears.

If the hum bar disappears when the last i.f. amplifier tube is removed, it indicates the faulty tube is in the i.f. amplifier or front end (r.f. amplifier, oscillator, or mixer).

Since the tuner and i.f. amplifier respond only to r.f. and i.f. signals, 60-cycle heater-to-cathode leakage cannot pass through to the video amplifier unless a signal which it can modulate is present.

A quick over-all check for heater-

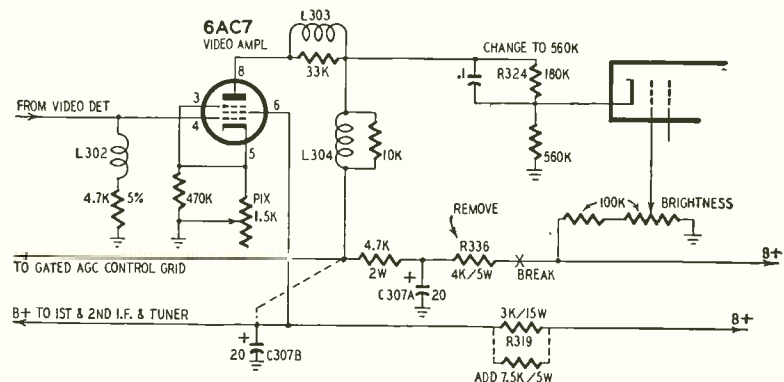

Fig. 3—Video amplifier of the 21F1 chassis. Some component values may vary with different production runs.

NEW 1955

Heathkit Engineering Features

New PRINTED CIRCUITS

One of the many tremendous improvements in the new 1955 Heathkits is the use of an etched metal process printed circuit board. Printed circuits will be used in Heathkits whenever they will affect construction simplification, performance stabilization, and lend themselves to design. Now for the first time a kit instrument company offers the advantages of modern printed circuit instrument construction technique. For the first time consideration has been given toward reducing kit assembly time. Also this is the first time that printed circuit boards have been hand soldered on a volume basis. Offered only by Heathkit, the pioneer and leader in kit instrument design.

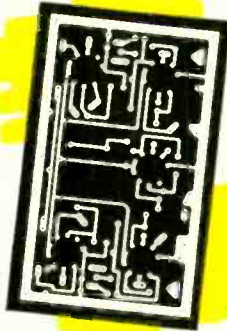

New PEAK-TO-PEAK VTVM CIRCUIT

New 6ZL5 full wave rectifier in AC input circuit permits full scale peak-to-peak measurements. Seven ranges—upper limits 4000 volts peak-to-peak. Just the thing you TV servicemen have needed in making TV circuit voltage checks. Precision resistor voltage divider limits AC RMS level to 150 volts. Prevents overloading the rectifier—extends upper limit AC RMS ranges to 1500 volts—further protects meter and circuitry against AC flash-over or arcing. Another definite example of continuing Heathkit design leadership in the kit instrument field.

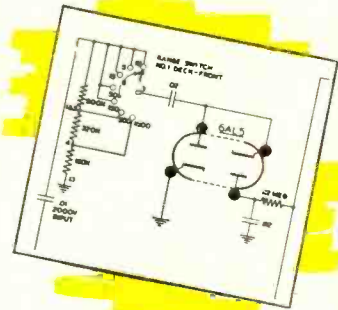

New HIGH READABILITY PANELS

New 1955 Heathkits feature complete panel redesign. Sharp white lettering applied to the beautiful charcoal gray panels, provide a new high in readability. Lettering is easy-to-read open style and panel calibrations are vividly clear against the pleasing soft gray background. New knobs of exclusive Heathkit design.



New 3" UTILITY SCOPE

The new 3" Scope is a "natural" for the well rounded line of Heathkit instruments. Small in size, 11 3/4" deep, 6 1/2" wide, 9 1/2" high, yet big in performance. Just think of the value, an Oscilloscope for \$29.50. Brilliant intensity, sharp focusing, wide positioning range. An ideal portable Scope for the TV serviceman—a second shop scope—modulation monitor for your hams (deflection plate terminals in rear of cabinet). Performance to spare for all general scope applications. See specifications on following page.



New STYLING New COLOR

New styling and coloring is responsible for tremendous improvement in Heathkit appearance. The new instrument panel color combination is high definition white lettering in a soft charcoal gray panel. Cabinet color is a lighter feather gray. The satin gold baked enamel cabinet for the WA-P2 Pre-amplifier is further indicative of the modern pacesetter trend in Heathkit styling.



New SCOPE SWEEP CIRCUIT 10 CYCLES — 500 KC

New 1955 Heathkit Model 0-10 Scope features a new wide frequency range sweep generator covering 10 cycles to 500,000 cycles. This coverage is available in five virtually decadeing sweep frequency ranges five times greater than the sweep frequency range usually available. Excellent retrace time characteristics, actually less than 20% at 500 KC. Use of the free running Heath circuit provides a larger margin of stability and a new high in Heathkit Scope performance.

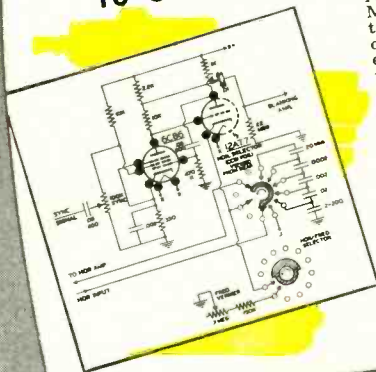

Continuing PROGRESS FUTURE LINE EXPANSION

The outstanding improvements featured in the 1955 Heathkit line are representative of the progress characteristic of the Heath Company operation. Long range planning will provide a continuing succession of new kit releases to further expand the Heathkit line which already represents the world's greatest selection of electronic kits. The innovations in the 1955 line, are representative of additional new models scheduled for release for the coming years.



SEE THE INSTRUMENTS ON THE FOLLOWING PAGES

HEATH COMPANY • • Benton Harbor 20, Mich.

Heathkit ELECTRONIC SWITCH KIT

The basic function of the Heathkit Electronic Switch Kit is to permit simultaneous oscilloscope observation of two separate traces which can be either separated or superimposed for individual study. This is accomplished through the use of two individually controlled inputs working through amplifier, multi-vibrator, and blocking stages. The output of the Electronic Switch is connected directly to the vertical input of the Oscilloscope. A typical example of usefulness would be simultaneous observation of a signal or waveform as it appears at both the input and output stages of an amplifier.

APPLICATIONS

An Electronic Switch has many applications to increase the over-all operating versatility of your oscilloscope. It can be used to check amplifier distortion—audio crossover networks—phase inverter circuits—to measure phase shift—special waveform study, etc. The instrument can also be conveniently used as a square wave generator over the range of switching frequencies, often providing the necessary wave form response information without incurring the expense of an additional instrument. Ownership of this instrument will reveal many entirely new fields of oscilloscope application and will quickly justify the modest cost of the Electronic Switch Kit.

Tube complement:
2—6X4, 2—6SN7,
1—6X5.

Continuously variable
switching rates in three
ranges from less than 10
CPS to over 2000 CPS.



Individual input
gain controls, po-
sition control,
coarse frequency
control, and fine
frequency control.

Transformer operated for
safety when used in con-
junction with other equip-
ment.

MODEL S-2

\$23⁵⁰

Shpg. Wt.
8 lbs.

Heathkit VOLTAGE CALIBRATOR KIT



MODEL VC-2

\$11⁵⁰

Shpg. Wt. 4 lbs.

Another useful oscilloscope accessory particularly in circuit development work and in TV and radio service work. The Voltage Calibrator provides a convenient method for making peak-to-peak voltage measurements with an oscilloscope, by establishing a relationship on a comparison basis between the amplitude of an unknown wave shape and a known output of the voltage calibrator. Peak-to-peak voltage values are read directly from a calibrated panel scale without recourse to involved calculations.

FEATURES:

To off-set line voltage supply irregularities, the instrument features a voltage regulator tube. A convenient "signal" position on the panel switch by-passes the calibrator completely and the signal is applied through the oscilloscope vertical input, thereby eliminating the necessity for constantly transferring test leads.

RANGES:

With the Heathkit Voltage Calibrator it is possible to measure all types of complex waveforms within a voltage range of .01 to 100 volts peak-to-peak. Build this instrument in a few hours and enjoy the added benefits offered only through combination use of test equipment.

Heathkit LOW CAPACITY PROBE KIT



No. 342

\$3⁵⁰

Shpg. Wt. 1 lb.

An oscilloscope accessory, the 342 Low Capacity Probe permits observation of complex TV waveforms without distortion. An adjustable trimmer provides proper matching to any conventional scope input circuit. Excellent for high frequency, high impedance, or broad bandwidth circuits. The attenuation ratio can be varied to meet individual requirements.

Heathkit SCOPE DEMODULATOR PROBE KIT



No. 337-C

\$3⁵⁰

Shpg. Wt. 1 lb.

Extend the usefulness of your oscilloscope by observing modulation envelopes of RF or IF carriers found in TV and radio receivers. The Heathkit Demodulator Probe will be helpful in alignment work, as a gain analyzer and a signal tracer. Easy construction with the new modern printed circuit board. Voltage limits are 30 volts RMS and 500 volts D.C.

HEATH company

BENTON HARBOR 20,
MICHIGAN

TELEVISION

cathode leakage would consist of shorting the cathodes of suspected tubes to ground temporarily; the hum will disappear when the faulty tube has been located.

A frequent hum problem is 60-cycle pulling of the picture without any hum bars on the screen. In such a situation, the trouble is probably in the sync separator or the horizontal a.f.c. circuit or oscillator. Heater-to-cathode leakage in these tubes causes changes in sync phasing which results in picture pulling. This effect will be present only with the signal, and can be checked by removing the picture (short the antenna terminals).

When the screen shows evidence of both 60-cycle hum bars and 60-cycle pulling, the indication is that the heater-to-cathode leakage is not in the deflection circuits but in the video signal path, prior to the sync take-off.

When pinning the trouble down to the video amplifier, include in your checking the video detector, d.c. restorer, the picture tube itself, and any other circuit that would respond to 60-cycle signals. Removing the last video amplifier tube provides a check on the C-R tube.

Very little has been said about hum in the vertical circuits. Since the hum and vertical scanning frequencies are the same, the usual effect of hum in these circuits is to distort the sweep into extreme nonlinearity that cannot be corrected by ordinary linearity adjustments.

Picture cutoff

I have in my shop an Admiral model 21F1. When no signal is coming in I have a good raster, but when I tune to a station, the picture goes dead. All the tubes check O.K. and all the resistance values seem to check. I have noticed that when the picture goes off there is too much negative bias in the video amplifier. Any information you could give me would be deeply appreciated. V. M., Franklin, N. Y.

Your trouble is due to blocking in the video amplifier. This condition is especially noticeable with strong signals which drive the video amplifier to cutoff. This set has direct coupling between the video amplifier and C-R tube. With the video amplifier cut off, B plus applied to the cathode of the picture tube will increase, making the grid voltage more negative with respect to cathode and driving the picture tube to cutoff.

Also since the gated a.g.c. tube is dependent upon voltage from the video amplifier for its operation, video amplifier blocking prevents a.g.c. voltage from being developed and the system remains blocked.

To correct this condition, the manufacturer suggests the following changes in the B plus circuit (see Fig. 3): Remove resistor R336 (4,000 ohms), isolating the brightness circuit from the plate supply of the video amplifier;

NEW *Heathkit* 5" PUSH-PULL OSCILLOSCOPE KIT PRINTED CIRCUIT

The new 1955 Heathkit Model O-10 is the first truly color television kit oscilloscope with necessary high sensitivity and bandwidth. Outstanding instrument appearance is the result of new modern styling and color harmony. The first kit constructed oscilloscope to offer a labor-saving printed circuit board. New sweep generator with frequency range five times greater than previous models. Additional major improvements are a new high voltage power supply, improved vertical and horizontal electronic positioning control action, extreme horizontal amplifier sensitivity for trace magnification over three times CRT face width.

NEW SWEEP GENERATOR: The first sweep generator outside of expensive Laboratory units to go above 100 KC. Yet this new Heathkit has five times the frequency range with stable, locked-in traces. Complete range 10 cycles to 500,000 cycles. The generator has such excellent synchronization characteristics, that the results closely approximate a triggered sweep and under most conditions, the trace is locked to a multiple of sync frequency throughout the entire control range. Sweep multi-vibrator is direct coupled pentode-triode and frequency determining capacitors are not part of multivibrator circuit.

Simplified, standardized construction technique of vertical and horizontal amplifier construction made possible through the use of a single printed circuit board.

SENSITIVITY AND BANDWIDTH: Operating characteristics of the newly designed vertical amplifier provide a high degree of sensitivity (25 millivolts per inch) and excellent bandwidth characteristics 5 cycles to 5 MC (down only 5 db). Only the new Heathkit Oscilloscope has the necessary sensitivity for full 5 megacycle bandwidth for color servicing. Uniformly high level operation with a high degree of stability is assured through the use of new printed circuit board construction. Printed circuits reduce the assembly time, error possibility, and provide rigid mounting for all components.

New horizontal amplifier provides trace width three times the diameter of the CR tube. This new amplifier together with DC positioning, allows greater magnification of trace for observation of small transients and step portions of TV sync pulses.

OTHER OUTSTANDING FEATURES: Retrace amplifier—Z axis modulation—peak-to-peak voltage calibrating source with calibrated grid—all plastic molded condensers for long trouble-free life and drift elimination—voltage regulated power supply—new wiring harness for neat professional appearance—new cabinet styling and color harmony. Combinations of design and performance features available only in the new Heathkit O-10 Oscilloscope.

First color television service Oscilloscope with necessary high sensitivity and full 5 megacycle bandwidth.

New printed circuit construction, all components mounted on high insulating surface resulting in uniformly low circuit capacities.

New type wide frequency range Heath sweep generator, 10 cycles to 500,000 cycles.

New 5BP1 CR tube



New cabinet styling and color harmony—charcoal gray panel with high readability white lettering.

New electronic positioning controls for instantaneous, definite positioning without bounce or overshoot.

MODEL O-10

\$69⁵⁰

Shpg. Wt. 27 lbs.

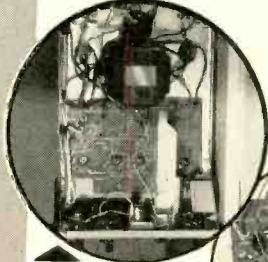

Clean, open, under chassis construction and wiring. Possible only through use of pre-cabled wiring harness, and simplified printed circuit boards.

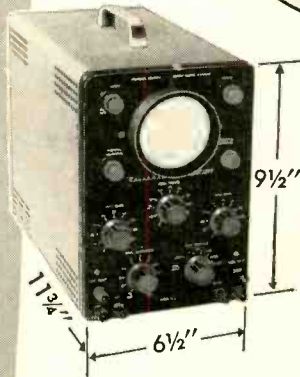
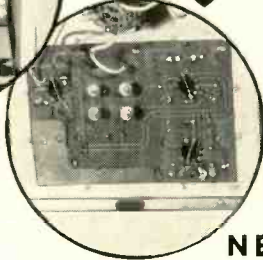

NEW *Heathkit* 3" PRINTED CIRCUIT OSCILLOSCOPE KIT

MODEL OL-1

\$29⁵⁰ Shpg. Wt. 15 lbs.

New easy-to-build printed circuit board with high insulation factor.

New Heathkit instrument styling—charcoal gray panel with high readability white lettering.

New Heath twin triode sweep generator 15-100,000 cycle sweep.

New compact utility Scope—light-weight—portable for service work.

Deflection plate terminals—Ideal for ham transmitter modulation monitoring.

Here is the newest addition to the line of Heathkit Oscilloscopes. Just the instrument you servicemen, hams, students, and experimenters have been asking for. A general purpose low priced utility scope to be used in everyday work. Through the use of a 3" 3GP1 CRT it has been possible to reduce the cabinet size and weight so that the instrument is a compact portable unit especially useful for TV servicemen to carry on home service calls and as an extra shop utility scope. At this low price every ham can afford an oscilloscope for transmitter modulation monitoring. Convenient slide switch controlled terminals at rear of scope cabinet.

PRINTED CIRCUIT: This new Heathkit uses a prefabricated printed circuit board to standardize amplifier and sweep generator assembly. Cuts building time in half, eliminates major portion of wiring, and insures exact duplication of engineering pilot model. Condensers, resistors, and tube sockets are mounted directly on the board and soldered in place.

DESIGN FEATURES: Cathode follower input circuits in both vertical and horizontal amplifier—electronic positioning control for wide range of vertical or horizontal spot deflection—Heath twin triode sweep generator—provisions for external and internal sync—external and internal sweep—60 cycle line sweep—Chicago power transformer—4 section electrolytic filter condenser—plastic molded bypass and coupling condensers. Tube lineup 4—12AU7 horizontal and vertical amplifiers, 12AX7 sweep generator, 6X4 low voltage rectifier, 1V2 high voltage rectifier, 3GP1 CRT. Cabinet size 11 3/4" deep x 6 1/2" wide x 9 1/2" high. A terrific instrument value at \$29.50.

NEW

Heathkit

5" PRINTED CIRCUIT

OSCILLOSCOPE KIT

MODEL OM-1

\$39⁵⁰ Shpg. Wt. 24 lbs.

Printed circuit board construction for accurate trouble-free assembly.

Twin triode Heath sweep generator 15-100,000 cycle range.

By popular request we are again offering a 5" full sized general purpose Oscilloscope using a 5BP1 CRT. All of the necessary design features for servicemen, students, experimenters, hams, etc. This fine oscilloscope value features printed circuit board construction for easy assembly and reduced wiring time. Also features the new Heathkit styling and color harmony with the charcoal gray panel and white lettering for high readability.

SWEEP GENERATOR: Sweep generator range using Heath twin triode circuit 15-100,000 cycles in four positions. Provisions for external as well as internal sweep and external or internal sync in addition to 60 cycle line sweep. Easy positive synchronization.

Heavy duty power supply using TV type 1V2 high voltage rectifier assures adequate accelerating potential for good trace definition. Deflection plate direct terminal connections available on rear of cabinet. Useful in transmitter modulation checking.

Good performance, simplified operation, and easy assembly are all characteristics of this new model Heathkit Oscilloscope.



HEATH company

BENTON HARBOR 20,
MICHIGAN

Heathkit MULTIMETER KIT

The new Heathkit Multimeter is a "must" to complete the instrument lineup of any well equipped service shop. Here is an instrument packed with every desirable service feature, many of which are not found in other Multimeters. All of the measurement ranges you need or want. High sensitivity 20,000 ohms per volt DC; 5,000 ohms per volt AC.

★ ADVANTAGES

Complete portability through freedom from AC line power operation—provides service ranges of direct current measurements from 150 microamps up to 15 amperes—can be safely operated in RF fields without impairing accuracy of measurement.

★ RANGES

Full scale AC and DC voltage ranges are 0-1.5, 5, 50, 150, 500, 1500 and 5,000 volts. Direct current ranges are 150 microamps, 15, 150 and 500 milliamperes and 15 amperes. Resistances are measured from 2 ohms to 20 megohms in 3 ranges and db range from -10 to +65 db.

★ CONSTRUCTION

The Heathkit MM-1 features a unique resistor ring switch mounting assembly procedure. With this method of assembly the precision resistors are wired to the rings and range switch before actual mounting of the switch to the instrument panel. This procedure affords the advantage of simpler construction yet complete accessibility of precision resistors in event replacement is ever required. Ohmmeter batteries were selected for convenience of replacement and only standard commercially available types are used. Batteries consist of 1 type C flashlight cell and 4 Penlite cells. All batteries and necessary test leads are furnished with the kit.

20,000 ohms per volt sensitivity DC; 5,000 ohms per volt AC.

Polarity reversal switch eliminates transferring of test leads.



All 1% precision multiplier resistors—sensitive 50 Simpson meter.

Total of 35 meter ranges on two color scale.

New modern cabinet styling—attractive appearance.

MODEL MM-1

\$26⁵⁰

Shpg. Wt. 6 lbs.

Heathkit HANDITESTER KIT



MODEL M-1

\$14⁵⁰

Shpg. Wt. 3 lbs.

The Heathkit Model M-1 Handitester readily fulfills major requirements for a compact, portable volt-ohm milliammeter. The small size of the smooth gleaming molded bakelite case permits the instrument to be tucked into your coat pocket, toolbox or glove compartment of your car. Always the "Handitester" for those simple repair jobs.

RANGES:

Despite its compact size, the Handitester is packed with every desirable feature required in an instrument of this type. AC or DC voltage ranges, full scale, 10, 30, 300, 1,000 and 5,000 volts. 2 convenient ohmmeter ranges 0-3,000 ohms and 0-300,000 ohms. 2 DC milliammeter ranges 0-10 milliamperes and 0-100 milliamperes.

CONSTRUCTION

The instrument uses a 400 microampere meter movement which is shunted with resistors to provide a uniform 1 milliampere load in both AC and DC ranges. This design allows the use of but 1 set of 1% precision divider resistors on both AC and DC and provides a simplicity of switching. A small hearing aid type ohms adjust control provides the necessary zero adjust function on the ohmmeter range. The AC rectifier circuit uses a high quality Bradley rectifier and a dual half wave hookup. Necessary test leads and battery are included in the price of this popular kit.

Heathkit RESISTANCE SUBSTITUTION BOX KIT

MODEL RS-1

\$5⁵⁰



Shpg. Wt. 2 lbs.

36 standard RTMA 1 watt resistor values between 15 ohms and 10 megohms with an accuracy of 10% are at your fingertips in the Model RS-1 Resistance Substitution Box kit. This sturdy and attractive accessory will easily prove its worth many times over as a time saving device. Order several today.

Heathkit CONDENSER SUBSTITUTION BOX KIT

MODEL CS-1



\$5⁵⁰

Shpg. Wt. 2 lbs.

18 standard RTMA values are available from .0001 mfd to .22 mfd. An 18 position switch set in the panel of an attractive bakelite case allows quick changes without touching the test leads. Invest a few minutes of your time now and save hours of work later on.

HEATH company

BENTON HARBOR 20,
MICHIGAN

TELEVISION

connect a 7,500-ohm, 5-watt resistor across R319; connect together the positive terminals of filter capacitors C307A and C307B (20 μ f each); change resistor R324 in the video amplifier-to-picture tube circuit from 180,000 ohms to 560,000 ohms.

No raster

I have a Sentinel model 412 that has had an intermittent raster for some time. It has now gone off completely but the sound is normal. I have checked all tubes without success. What should I check for next? T. M., Bloomington, Ind.

This trouble is most likely caused by a defective component in the horizontal sweep circuit. First check the output-tube screen voltage for a possible open circuit. Also check the drive control capacitor for a possible short circuit.

Then check the horizontal lock coil in the horizontal oscillator circuit for a possible open circuit. The .001- μ f coupling capacitor feeding the output tube grid is a frequent cause of trouble—it might be well worth while replacing it.

Next check the horizontal output transformer for open or partially shorted windings. When defective, the transformer will seriously distort the sawtooth wave. This can be quickly checked by observing the waveform across the linearity coil. A defective transformer will cause the waveform to appear as a ripple instead of a sawtooth.

Neck shadow

After converting a Video Products receiver, I ran into shadows at the edges of the picture that could not be eliminated. I have good vertical and horizontal sweep voltages. The ion-trap magnet and the focus coil are both properly adjusted on the 24AP4 picture tube. L. K., Chicago, Ill.

The condition you describe, neck shadow, can be caused by a number of things. Since you have checked the ion trap and focus coil adjustments, it will be necessary to locate the deflection yoke very carefully. Move the yoke as far forward along the neck of the tube as is physically possible. This is especially important in connection with the larger tubes.

Oftentimes the rubber bumpers on the front of the yoke holding bracket, or the difference between the yoke flare and that of the tube forces the yoke too far back along the neck of the tube. If this is the trouble, it will be necessary to obtain a better fitting yoke. This is not unusual since neck contours of various cathode-ray tubes may cause as much as $\frac{1}{4}$ inch difference in the forward movement of the yoke.

FM interference

We are having considerable trouble on channel 9 which is 40 miles from us. A local FM station, WKJF, is located approximately 3 miles from us and causes a great deal of interference. We

NEW *Heathkit* VACUUM TUBE VOLTMETER KIT PRINTED CIRCUIT DESIGN

Another outstanding example of continuing Heath Company pioneering and leadership in the kit instrument field. A new **printed circuit** VTVM. New peak-to-peak circuit—new styling and new panel design. A prewired, prefabricated printed circuit board eliminates chassis wiring, cuts assembly time in half, assures duplication of Engineering pilot model specifications, and virtually eliminates possibility of construction error.

CIRCUIT:

A 6AL5 tube operated as a full wave AC input rectifier permits seven peak-to-peak voltage ranges with upper limits of 4000 volts P-P. Just the ticket for you TV servicemen. Voltage divider in the 6AL5 input circuit limits applied AC input to a safe level. This circuitry and the isolation of the meter in the cathode of the 12AU7 bridge circuit affords a high degree of protection to the sensitive 200 microampere meter.

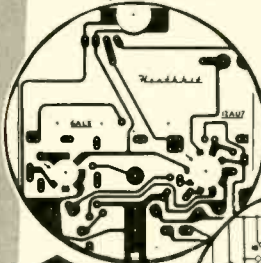

The first kit instrument to offer a labor-saving, error-free printed circuit board. Your instrument an exact wiring replica of Engineering development model.

Full wave rectifier in AC input circuit. Read peak-to-peak and RMS volts with upper limit of 4000 P-P and 1500 volts RMS. Voltage divider input circuit.

RANGES:

Seven voltage ranges, 1.5, 5, 15, 50, 150, 500 and 1,500 volts DC and AC RMS. Peak-to-peak ranges 4, 14, 40, 140, 400, 1400, 4000. Ohmmeter ranges X1, X10, X100, X1000, X10K, X100K, X1 meg. Additional features are a db scale, a center scale zero position, and a polarity reversal switch.

IMPORTANT FEATURES:

High impedance 11 megohm input—transformer operated—1% precision resistors, 6AL5 and 12AU7 tube—selenium power rectifier—individual AC and DC calibrations—smoother improved zero adjust control action—new panel styling and color—new placement of pilot light—new positive contact battery mounting—new knobs—test leads included.

The new V-7 also sets the pace as a kit instrument style leader. Smart, good-looking charcoal gray panel and soft feather gray cabinet. High readability panel with sharply contrasting white calibrations. The pleasing, eye catching, modern styling is in harmonious balance with the outstanding circuit design improvements. Easily the best buy in kit instruments.

New charcoal gray baked enamel panel with high readability, white lettering. New soft feather gray cabinet, subdued pilot light indicator.

New printed circuit board for faster, easier construction—exact duplication of Lab development model.



New easy-to-read open panel layout. Off-on switch now incorporated in the selector switch.

MODEL V-7

\$24.50

Shpg. Wt. 7 lbs.

New peak-to-peak meter scale—new color harmony—new knobs.

Heathkit AC VACUUM TUBE

VOLTMETER KIT

MODEL AV-2

\$29.50

Shpg. Wt. 5 lbs.



Extreme sensitivity has been emphasized in the design of the Heathkit AC VTVM. Ten full scale RMS ranges are .01, .03, .1, .3, 1, 3, 10, 30, 100, and 300 volts. Frequency response is substantially flat from 10 cycles per second to 50 KC with input impedance of 1 megohm at 1 KC. Will accurately measure as low as 1 millivolt at high impedance. Total db range is -52 db to +52 db. An excellent kit for measuring

the output of phono cartridges and the gain of amplifier stages. Use it also to check power supply ripple, as a sensitive null detector, and for compiling frequency response data. Features one knob operation, 200 microampere Simpson meter and precision resistors.

Heathkit 30,000 VOLTS DC PROBE KIT

Measure up to 30,000 volts DC with the Heathkit VTVM and the 336 high voltage Probe. Precision resistor provides multiplication factor of 100. Can be used with any 11 megohm input VTVM. Housed in a Polystyrene two color sleek plastic probe body for safety of operation.

No. 336

\$45.00

Shpg. Wt. 1 lb.



Heathkit PEAK-TO-PEAK PROBE KIT



No. 338-C

\$5.50

Shpg. Wt. 2 lbs.

Peak-to-peak values not exceeding 80 volts at a DC level of not more than 600 volts, can now be read directly by using 338-C Probe with previous model Heathkit VTVM's or any VTVM with 11 megohm input resistance. Probe construction features a modern printed circuit board for easy assembly. Frequency range 5 KC to 5 MC.

Heathkit RF PROBE KIT

The Heathkit RF Probe will permit the measurement of RF voltages up to 250 MC with an accuracy of $\pm 10\%$. The limits are 30 volts AC and a DC level of 500 volts. Designed for any 11 megohm input VTVM. Modern styling. Polystyrene aluminum housing. Polystyrene insulation, and printed circuit board for easy assembly.

No. 309-C

\$3.50

Shpg. Wt. 1 lb.



Heathkit

AUDIO WATTMETER KIT

Read audio power output directly without using external load resistors with the new Heathkit Audio Wattmeter. Built-in non-inductive load resistors provide impedances of 4, 8, 16, and 600 ohms. Flat response from 10 CPS to 250 KC. Full scale power ranges are 0-5 MW, 0-50 MW, 0-500 MW, 0-5 W and 0-50 W. Model AW-1 will operate continuously at 25 watts and has a duty cycle of 3 minutes at 50 watts. Total db range in five positions is -50 db to +48 db, using the standard 1 milliwatt 600 ohms.

MODEL AW-1

\$29.50

Shpg. Wt. 6 lbs.



HEATH company

BENTON HARBOR 20,
MICHIGAN

Heathkit 6-12 VOLT BATTERY ELIMINATOR KIT

Here is the new 12 volt Heathkit Battery Eliminator so necessary for modern up-to-date operation of your Service Shop. Furnishes either 6 or 12 volt output which can be selected at the flick of a panel switch. Use the BE-4 to service all of the new 12 volt car radios in addition to the conventional 6 volt models.

RANGES:

This new Battery Eliminator provides two continuously variable output voltage ranges. 0-6 volts D.C. at 10 amperes continuously or 15 amperes maximum intermittent and 0-12 volts D.C. at 5 amperes continuously or 7.5 amperes maximum intermittent. The output voltage is clean and well filtered, as the circuit uses two 10,000 mfd condensers.

The continuously variable voltage output feature is of definite aid in determining the starting point of vibrators, the voltage operating range of oscillator circuits, etc.

OTHER USES:

The controllable low voltage DC supply has many other applications besides primary use in car radio service work. Can be nicely used as a battery charger, or low voltage DC supply for electric trains. Has applications in high gain audio work requiring clean DC filament supply. Can be used for low power electro-plating or as a power supply for battery powered intercommunication systems.

Automatic overload relay—self resetting—fuse protected.

New 18 plate split type, heavy duty rectifier unit.

Continuously variable output voltage, either 6 or 12 volt operation.

Constant ammeter and voltmeter monitoring.

MODEL BE-4

\$31⁵⁰

Shpg. Wt. 17 lbs.



Heathkit VIBRATOR TESTER KIT

MODEL VT-1

\$14⁵⁰

Shpg. Wt. 6 lbs.



This time-saving device will quickly pay for itself in your auto radio service shop. 6 volt vibrators can be checked instantly on the Good—Bad type meter scale. Operation requires only a variable DC voltage from 4 to 6 volts at 4 amperes. Model BE-4 Battery Eliminator is recommended for this application.

Five test sockets provide for the testing of hundreds of inductor and self-rectifier types. Proper starting voltage is determined easily and accurately. Over-all quality is then unmistakably indicated on the panel mounted meter.

Heathkit IMPEDANCE BRIDGE KIT

MODEL IB-2

\$59⁵⁰ Shpg. Wt. 12 lbs.



The new Heathkit Impedance Bridge features built-in adjustable phase shift oscillator and amplifier. This instrument actually represents four instruments in one compact unit. The Wheatstone bridge for resistance measurements, the Capacity Comparison bridge for capacity measurements, Maxwell bridge for low Q, and Hay bridge for high Q measurements.

DESIGN:

Panel provisions for external generator use. A new two section CRL dial, provides ten separate "units." Ten separate units switch settings and fractions of units are read on a continuously variable calibrated control. A special minimum capacity shielded and balanced impedance matching transformer between the generator and bridge circuit is automatically switched to provide correct load operation of the generator circuit. The instrument uses 1/2% precision resistors and condensers in all measurements circuits.

Heathkit VARIABLE VOLTAGE ISOLATION TRANSFORMER KIT

Variable output voltage between 90 and 130 volts AC. Rated at 100 volt—amperes continuously and 200 volt—amperes intermittently. The principle function of the Heathkit Isolation Transformer is to isolate the circuit being tested from line interference being caused by motors, appliances, etc. It works backward too by isolating such devices from the line. Many other uses, especially with AC-DC type circuits. Do not confuse the Heathkit Isolation Transformer with the hazardous auto transformer type line voltage boosters.

MODEL IT-1

\$16⁵⁰

Shpg. Wt. 10 lbs.



HEATH company
BENTON HARBOR 20,
MICHIGAN

TELEVISION

have tried various stubs and traps but they have not been of any help. What do you suggest we do? J. M., Pittsburgh, Pa.

FM station WKJF broadcasts on 93.7 mc. The second harmonic of this would be 187.4 mc, which falls within the channel 9 band (186 to 192 mc). Thus the interference is that of second harmonic radiation of the FM station.

There is no way of separating the second harmonic of the FM signal from the fundamental of the TV signal. Both frequencies are the same and a tuned circuit or trap does not distinguish one from another. However you can correct the situation if the signals are coming from different directions. Try using a highly directional antenna such as the Yagi. If the interference is severe it may be necessary to use a separate antenna cut just for channel 9. Orient it for minimum interference.

Also check with other service technicians in your area. If this complaint is prevalent, you might check with the station as to whether they may be exceeding their permissible harmonic radiation.

Noise when picture appears

On a Motorola model VT107 the sound appears after the normal warm-up time (about 15 seconds). There is no high voltage and hence no raster for about 45 seconds, then there is a loud, piercing noise from the speaker and the raster and picture appear. This condition has prevailed for two months and does not seem to get worse. I have replaced all tubes in the horizontal sweep and high-voltage sections and all voltages test normal. The sawtooth voltage waveform appears at the grid of the 6BG6 prior to the noise. What can I do?—R. B., Lebanon, Pa.

This is caused by a defective component in the horizontal output or high-voltage system. The fact that you get a sawtooth voltage waveform at the grid of the 6BG6-G prior to the appearance of high voltage would confine the trouble to the horizontal amplifier tube or the transformer. The noise in the speaker when the high voltage appears would indicate that an arc closes a circuit to permit high voltage generation. First check the screen and cathode capacitors of the horizontal output tube. Also check for defective capacitors in the voltage-boost circuit in the cathode of the damper tube. These capacitors are connected to each side of the linearity-control coil.

It is also possible that you have an intermittent condition in the horizontal output transformer. Since high voltage appears only after warmup, check continuity quickly before the receiver has been on long enough to warm the transformer. Sometimes the heat generated in a receiver will expand the copper windings of a transformer enough to close a broken connection. Also make sure the 1B3-GT socket makes good contact with the tube pins and does not have a loose connection or cold-soldered joint.

END

NEW *Heathkit* TV ALIGNMENT GENERATOR KIT

Here is the most radically improved Sweep Generator in the history of the TV service industry. The basic design follows latest high frequency techniques which result in a combination of performance features not found in any other sweep generator.

SWEEP:

Sweep action is obtained electronically through the use of a newly developed controllable inductor, thereby eliminating all moving parts with their resultant hum, vibration, fatigue, etc. Frequency coverage entirely on fundamentals, is continuous from 4 MC to 220 MC at an output level well over a measurable .1 volt.

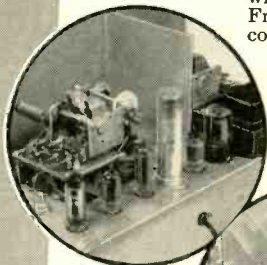

Triple marker system, 4.5 MC crystal controlled marker—continuously variable marker—provisions for external marker.

Automatic amplitude control circuit—constant output voltage regulated power supply.



MARKER:

The same instrument incorporates a triple marker system with a crystal controlled reference. A variable marker provides accurate coverage from 19 to 60 MC on fundamentals, and 57 to 180 MC on calibrated harmonics. A separate fixed crystal controlled 4.5 MC marker can be used for checking IF, band-pass, calibration, reference, etc. Provisions are also made for external marker use. A 4.5 MC crystal is supplied with the kit.

POWER SUPPLY:

The transformer operated Power Supply features voltage regulation for stable oscillator operation. Three sets of shielded cables are furnished with the kit. Sweep range is completely and smoothly controllable from zero up to a maximum of 50 MC, depending upon base frequency.

Here is a TV Sweep Generator that truly no serviceman can afford to be without for rapid, accurate, TV alignment work.

Controllable inductor sweep oscillator with output entirely on fundamentals.

Triple marker system 4.5 MC crystal controlled—3 sets of cables included.

Electronically operated, smooth continuously variable sweep circuit—no vibration, hum or noise.

Frequency coverage: 4 MC—220 MC continuous including FM spectrum. RF output well over .1 volt.



MODEL TS-3

\$44.50

Shpg. Wt. 18 lbs.

NEW *Heathkit* SIGNAL GENERATOR KIT



MODEL SG-8

\$19.50 Shpg. Wt. 8 lbs.

The new Heathkit service type Signal Generator, Model SG-8 incorporates many design features not usually found in this instrument price range. Frequency coverage

is from 160 KC to 110 MC in five ranges, all on fundamentals, with useful calibrated harmonics up to 220 MC. The RF output level is well in excess of 100,000 microvolts throughout the frequency range. The oscillator circuit consists of a twin triode tube, one-half used as a Colpitts oscillator, and the other half as a cathode follower output which acts as a buffer between the oscillator and external load, thereby eliminating oscillator frequency shift usually caused by external loading.

All coils are factory wound and adjusted, thereby completely eliminating the need for individual calibration and the use of additional calibrating equipment. The stable, low impedance output, features step and variable attenuation for complete control of RF level. A separate 6C4 triode acts as a 400 cycle sine wave oscillator, and a panel mounted switching system permits choice of either external or internal modulation.

Heathkit LABORATORY GENERATOR KIT



MODEL LG-1

\$39.50

Shpg. Wt. 16 lbs.

The new Heathkit Laboratory type Signal Generator definitely establishes a new performance standard for a kit instrument. An outstanding feature involves the use of a panel mounted 200 microampere meter calibrated both in microvolts and percent modulation, thereby providing a definite reference level for using the Signal Generator in design work, gain measurements, selectivity, frequency response checks.

DESIGN:

Additional design features are copper plated shield enclosure for oscillator and buffer stages resulting in effective double shielding. Fibre panel control shaft extensions in RF carrying circuits, thorough AC line filtering, careful shielding of the attenuator network, voltage regulated B plus supply, selenium rectifier, etc.

RANGES:

Frequency coverage from 150 KC to 30 MC all on fundamentals in five separate ranges. Output voltage .1 volt with provisions for metered external or internal modulation. Output impedance termination 50 ohms. Transformer operated power supply.

Investigate the many dollar stretching features offered by the LG-1 before investing in any generator for Laboratory or Service work.

NEW *Heathkit* BAR GENERATOR KIT



MODEL
BG-1

\$14.50 Shpg. Wt. 4 lbs.

The Heathkit BG-1 produces a series of horizontal or vertical bars on a TV screen. Since these bars are equally spaced, they will quickly indicate picture linearity of the receiver under test without waiting for transmitted test patterns. Panel switch provides "standby—horizontal and vertical position." The oscillator unit uses a 12AT7 twin triode for the RF oscillator and video carrier frequencies. A neon relaxation oscillator provides low frequency for vertical linearity tests. The instrument will also provide an indication of horizontal and vertical sync circuit stability as well as overall picture size. Operation is simple and merely requires connection to the TV receiver antenna terminal. Transformer operated for safety.

HEATH company
BENTON HARBOR 20,
MICHIGAN

A SUPERUNUSUAL CASE

By GEORGE R. ANGLADO

Of all the TV receivers that ever came into our shop, never have we run across as unusual a problem as happened on a Transvision A television chassis.

This chassis is sold as a kit, and makes a very good set. The manufacturer guarantees it to perform if put together according to instructions and if no tinkering is done to the preset alignment screws. We have seen one of these kit sets wired up and working fine, but when our customer finished his it just wouldn't work! The trouble was no sync and a very weak picture.

Checking the wiring against the schematic and parts list, we found the customer had done a good construction job. All voltages measured O.K. Our next step was to start replacing tubes one by one until the faulty one was found (that is, *if it was a tube*). Starting with the tuner, we replaced all the tubes in this section, all the video-i.f. tubes, the horizontal oscillator and amplifier tubes, vertical oscillator and amplifier tubes, and finally the horizontal phase-detector, all with no change. Also, we even tried replacing the high-voltage rectifier and the damper, with no success.

Finally we were down to one last tube—the 6SN7 second sync amplifier-phase inverter. When we pulled this one out of its socket the picture jumped out on the screen like a poor scul finding a doorway out of hell. This, we thought, was our culprit. All we had to do now was put in a new tube. But, even at that, why did the set work *with the tube out*? We plugged in a new 6SN7, and—you guessed it—the picture disappeared again!

Well, we were just about ready to give it up and write the manufacturer when we decided to try one thing more—replace every resistor and capacitor in the second sync amplifier-phase inverter circuit. This changed absolutely nothing at all as far as the trouble was concerned, and was a total waste of time (so we thought, and so you are probably thinking). *But . . .* in putting back the original parts, we accidentally soldered in a .05- μ f capacitor instead of the .005- μ f unit supplied by the manufacturer. (This is capacitor C in the schematic on page 79.) Instantly the picture jumped up again on the screen! This really had our heads spinning. We then removed the 6SN7 and the picture went out again!

Brother! After that we figured it was time to close up shop and go into some kind of legitimate business, like politics.

We would like to know (very, very much so) how the devil did the set play with the 6SN7 out of its socket—that is, *before* the .05- μ f capacitor was put in by mistake? Why didn't this trouble happen on a previous set of
(Continued on page 79)

Heathkit
VISUAL-AURAL
SIGNAL-TRACER
KIT

The new Heathkit Visual-Aural Signal Tracer features a special high gain RF input channel used in conjunction with a newly designed wide frequency range demodulator probe. High RF sensitivity permits signal tracing from the receiver antenna input. Separate low gain channel and probe available for audio circuit exploration. Both input channels are constantly monitored by an electron ray beam indicator so that visual as well as aural indications may be obtained.

NOISE LOCATOR:

A decidedly unusual feature is a noise locator circuit used in conjunction with the audio probe. With this system, a DC potential is applied to a suspected circuit component and the action of the voltage in the component can be seen as well as heard. Invaluable for ferreting out noisy or intermittent condensers, noisy resistors, controls, IF and power transformers, etc.

WATTMETER:

Built-in calibrated wattmeter circuit will prove useful for quick preliminary check of total wattage consumption of equipment under test. Separate panel terminals provide external use of the speaker or output transformer for substitution purposes. Saves valuable service time by eliminating the necessity for speaker removal on every service job. The same panel terminals also provide easy access to a well filtered B plus supply for external use. Don't overlook the many interesting service possibilities provided through the use of this instrument, and let the Signal Tracer work for you by saving time and money.

RF and audio probes supplied along with necessary test leads.

Visual and aural signal tracing.

Substitution test speaker—utility amplifier.

Noise locator circuit—calibrated wattmeter.



MODEL T-3
\$23⁵⁰
Shpg. Wt. 9 lbs.

Heathkit CONDENSER CHECKER KIT



MODEL C-3
\$19⁵⁰ Shpg. Wt. 7 lbs.

Here is a handy test instrument for any Service Shop. Unknown values of capacity and resistance are quickly determined on the direct reading condenser checker dial. Capacity is measured in four ranges from .001 mfd to 1000 mfd. Resistance in the range from 100 ohms to 5 megohms.

DC polarizing voltages of 25, 150, 250, 350, and 450 volts are available for leakage tests on all types of condensers. For electrolytics, a power factor control is provided to balance out inherent leakage and to indicate directly the power factor of a condenser under test. Proper balancing of the AC bridge is reflected in the degree of closure of an electron beam indicator tube.

Model C-3 uses a transformer operated power supply, spring return leakage test switch, and a convenient combination of panel scales for all readings. Test leads are furnished in addition to precision components for calibrating purposes. Quick and easy to operate, the Heathkit Condenser Checker will save valuable time and increase your Shop efficiency.

Heathkit "Q" METER KIT



MODEL QM-1
\$44⁵⁰
Shpg. Wt. 14 lbs.

The Heathkit QM-1 represents the first practical popular priced Q meter available within the price range of schools, laboratories, TV service men, and experimenters. This instrument will enable the operator to simulate conditions encountered in practical circuits and to measure the performance of coils or condensers at the operating frequencies actually encountered. All indications of value are read directly on the 4 1/2" 50 microampere Simpson calibrated meter scale. Measures Q of condensers, RF resistance, and the distributed capacity of coils: Oscillator section supplies RF frequencies 150 KC to 18 MC in four ranges. Calibrate capacity with range of 40 MMF to 450 MMF with vernier of ± 3 MMF. Investigate the many services this instrument can perform for you.

Heathkit
AUDIO OSCILLATOR
KIT

MODEL AO-1
\$24⁵⁰
Shpg. Wt. 10 lbs.



The Heathkit Audio Oscillator will produce both sine and square waves within the frequency range from 20 CPS to 20 KC in three ranges. Thermistor controlled linearity results in a variation of no more than ± 1 db in a 10 volt (no load) variable output level. There will be less than .6% distortion from 100 CPS throughout the audible range. Low impedance 600 ohm output. Precision 1% resistors, used in the range multiplier circuits to provide accurate calibration.

HEATH company
BENTON HARBOR 20,
MICHIGAN

Heathkit TUBE CHECKER KIT

The Heathkit TC-2 Tube Checker was primarily designed for the convenience of radio and TV servicemen and will check the operating quality of tubes commonly encountered in this type of work. Test set-up procedure is simplified, rapid, and flexible. Panel sockets accommodate 4, 5, 6, and 7 pin tubes, octal and loctal, 7 and 9 pin miniatures, 5 pin Hytron, and a blank socket for new tubes. Built-in neon short indicator, individual 3-position lever switch for each tube element, spring return test switch, 14 filament voltage ranges, and line-set control to compensate for supply voltage variations, all represent features of the TC-2.

Illuminated for easy reading and quick identification of chart

Simplified construction — new harness type wiring — closer tolerance resistors.

Smart, professional appearance — available in counter or portable models.



Improved smooth running roll chart mechanical action.

Three color Good — 7-BAD 4 1/2" plastic cased meter.

MODEL TC-2
\$29.50
Shpg. Wt. 12 lbs.

Heathkit PORTABLE TUBE CHECKER KIT

The portable model is supplied with a strikingly attractive two-tone cabinet finished in rich maroon proxylin impregnated fabric covering with a contrasting gray on the inside of the detachable cover.

MODEL TC-2P
\$34.50
Shpg. Wt. 15 lbs.



Results of tube tests are read directly from the large 4 1/2" Simpson 3-color meter. Checks emission, shorted elements, open elements, and continuity. Wiring procedure has been simplified through the use of multi-wired color coded cable providing a harness type installation between tube sockets and lever switches. This procedure insures standard assembly and imparts a "factory built" appearance to the instrument. New Construction Manual furnishes detailed information regarding tube set-up procedure for testing of new or unlisted tube types. No delay necessary for release of factory data.

Heathkit REGULATED POWER SUPPLY KIT



MODEL PS-2
\$33.50 Shpg. Wt. 15 lbs.

Here is a source of regulated D.C. voltage for circuit development work. Power supply voltage and current drain to the circuit under test are constantly monitored by the 4 1/2" panel mounted meter. Separate 6.3 volt at 4 ampere A.C. filament source available. The regulated and variable output voltage will be constant over wide load variations, and hum ripple will not exceed .012% at 250 volts under a 50 MA load. Completely isolated circuit, standby switch, and other desirable features, make the Model PS-2 extremely useful in a wide variety of applications.

Heathkit TV PICTURE TUBE TEST ADAPTER

The Heathkit TV Picture Tube Test Adapter used with the Heathkit Tube Checker Kit, will quickly check picture tubes for emission, shorts, etc. and determine tube quality. Consists of standard 12-pin TV tube socket, four feet of cable, octal socket connector, and data sheet.



No. 355
\$4.50 Shpg. Wt. 1 lb.

Heathkit DECADE RESISTANCE KIT



MODEL DR-1
\$19.50
Shpg. Wt. 4 lbs.

Twenty 1% resistors are decade in 1 ohm steps to provide any value between 1 ohm and 99,999 ohms. Sturdy ceramic switches with silver plated contacts insure reliable service. Use the Decade Resistance in bridge circuits, meter multipliers, calibrations, or any application requiring a wide range of precision resistance values.

Heathkit AUDIO GENERATOR KIT

Here is an Audio Generator with features generally found only in the most expensive instruments. Sine wave coverage from 20 cycles to 1 Megacycle—response flat ± 1 db from 20 cycles to 400 Kc—continuously variable and step attenuated output. Because the output voltage is relatively constant over wide frequency ranges, the AG-8 is ideal for running frequency response curves in audio circuits. Once set by means of the attenuator, this voltage may be relied upon for accuracy within ± 1 db. Instrument features low impedance 600 ohm output circuit and distortion less than .4 of 1% from 100 CPS through audible range.



MODEL AG-8
\$29.50
Shpg. Wt. 11 lbs.

Heathkit DECADE CONDENSER KIT

The Heathkit Decade Condenser provides a ready source of capacity values from 100 mmf to .111 mfd inclusive in capacity steps of 100 mmf. Silver plated contacts on husky ceramic switches, assure positive contact for each switch position. Precision silver mica condensers $\pm 1\%$ accuracy for close tolerance accurate work.

MODEL DC-1
\$16.50
Shpg. Wt. 3 lbs.



HEATH company
BENTON HARBOR 20,
MICHIGAN

NEW *Heathkit* HIGH FIDELITY PREAMPLIFIER KIT

Here is the exciting new Heathkit Preamplifier with all of the features you Audiophiles have asked for and at a down-to-earth price level. Beautiful satin gold baked enamel finish, striking control knobs and arrangement, attractive custom appearance and entirely functional design.

DESIGN:

Uses three twin triode tubes in a shock mounted chassis, 2-12AX7 and 1-12AU7. Features tube shielding, plastic sealed color coded capacitors, smooth acting controls, good filtering, excellent decoupling, low hum and noise level, and all aluminum cabinet. Special balancing control for absolute minimum hum level. Cathode follower, low impedance output circuit for complete installation flexibility.

SPECIFICATIONS:

Provides five switch selected inputs, 3 high level, and two low level, each with individual level controls—4 position LP, RIAA, AES, and early 78 equalization switch—4 position roll-off switch, 8, 12, 16 with one flat position. Separate tone controls, bass 18 db boost and 12 db cut at 50 CPS, treble 15 db boost, and 20 db cut at 15,000 CPS. Power re-

Equalization for LP, RIAA, AES, and early 78.

Separate bass and treble tone controls—special hum control.



Cathode follower low impedance output circuit.

Beautiful, modern appearance, blends with any interior color scheme.

Five switch selected inputs with individual level controls.

quirements from Heathkit Williamson Type Amplifier power supply 6.3 volts AC at 1 ampere, and 300 volts DC at 10 MA. Overall dimensions 12 1/2" wide x 5 1/2" deep x 3 3/4" high.

APPLICATION:

The new Heathkit WA-P2 Preamplifier has been designed to operate with any of the Heathkit Williamson Type Amplifiers and is directly interchangeable with the previous Model WA-P1 Preamplifier unit. Order your kit today and enjoy completely smooth control over the operation of your Hi-Fi system. Obtain the exact tonal balance of bass and treble with the precise degree of equalization you want. Note that the design of the WA-P2 accommodates the newly established RIAA curve.

MODEL WA-P2

\$19.75

Shpg. Wt. 7 lbs.

HAM EQUIPMENT

Single knob band switching—pre-wound coils.



Crystal or VFO excitation—metered operation.

52 Ohm coaxial output—built-in power supply.

MODEL AT-1

\$29.50

Shpg. Wt. 16 lbs.

filter, good shielding and a 52 ohm coaxial output. The 425 volt, 100 milliampere power supply and 5U4 rectifier are more than adequate for the 6AG7 oscillator multiplier and 6L6 amplifier doubler.

Heathkit AMATEUR TRANSMITTER KIT

The Heathkit AT-1 Transmitter has established a high reputation and has been enthusiastically accepted by hundreds of experienced operators as well as beginners. Power input up to 35 watts for the novice and suitable as a standby exciter for your higher powered rig later on.

Model AT-1 can be crystal or VFO excited and operates on 80, 40, 20, 15, 11 and 10 meters. The pre-wound coils with the oscillator and amplifier are switched simultaneously by the rugged band switch. Meter switch allows a reading of the final grid and plate current on the panel mounted meter. Modulator input and VFO power sockets are provided as well as a key jack for CW operation. Other features include a crystal socket, standby switch, key click filter, AC line

Brand NEW

Smooth acting illuminated and precalibrated dial.

HEATHKIT VFO KIT

The new Heathkit VFO is the perfect companion to the Heathkit Model AT-1 Transmitter and it has sufficient output to drive any multi-stage transmitter of modern design. Good mechanical and electrical design insures operating stability. Coils are wound on stable, heavy duty, ceramic forms using Litz or double cellulose wire coated with Polystyrene cement and baked for humidity protection. Variable capacitor of differential type construction, especially designed for maximum bandsread. Kit is furnished with a carefully precalibrated scale which provides well over two feet of scale length. Smooth acting vernier reduction drive and illuminated dial provides easy tuning and zero beating.

Power requirements 6.3 volts AC at .45 amperes, and 250 volts DC at 15 mls. Just plug it into the power receptacle provided on the rear of the AT-1 Transmitter. Seven band coverage 160 through 10 meters with 10 volt average RF output. Uses 6AU6 electron coupled Clapp oscillator and OA2 voltage regulator.

Copper plated chassis—aluminum cabinet—easy to build.



Seven band coverage 160 through 10 RF output.

6AU6 electron coupled Clapp oscillator and OA2 voltage regulator.

MODEL VF-1

\$19.50

Shpg. Wt. 7 lbs.

Heathkit GRID DIP METER KIT

The invaluable instrument for Hams, servicemen and experimenters. Useful in TV service work, for alignment of traps, filters, IF stages, peaking compensation networks, etc. Locates spurious oscillation, provides a relative indication of power in transmitter stages. Use it for neutralization, locating parasites, correcting TVI, measuring CL and Q of components, and determining RF circuit resonant frequencies. The variable meter sensitivity control, headphone jack, 500 microampere Simpson meter, continuous frequency coverage from 2 MC to 250 MC. Pre-wound coil kit and rack included.

LOW FREQUENCY COILS:

Low frequency range extended to 355 KC by the use of two additional coils. Complete with dial correlation curves. Set 341-A for GD-1B and set 341 for GD-1A. Shpg. wt. 1 lb. Price \$3.00



MODEL GD-1B

\$19.50

Shpg. Wt. 4 lbs.

Heathkit ANTENNA IMPEDANCE METER KIT



MODEL AM-1

\$14.50

Shpg. Wt. 2 lbs.

Determine antenna resonance and resistance, transmission line surge impedance, and receiver input impedance. Works with one-half and one-quarter wave lines, half wave and folded dipoles, harmonic mobile and beam antennas. Resistance type SWR bridge—100 microampere meter—frequency range 0-150 MC—impedance range 0-600 ohms.



MODEL AC-1

\$14.50

Shpg. Wt. 4 lbs.

Heathkit ANTENNA COUPLER KIT

For the Heathkit AT-1 Transmitter or any comparable Amateur Transmitter. Will handle power up to 75 watts at its 52 ohm coaxial input. Matches a wide range of antenna impedances with its L type tuning network and neon indicator. A tapped inductance provides coarse adjustment and a transmitting type variable condenser sets it "right on the nose." Will operate on the 10 through 80 meter bands.

HEATH company
BENTON HARBOR 20,
MICHIGAN

New LOW PRICED HEATHKIT SINGLE UNIT Williamson Type High Fidelity AMPLIFIER KIT

Here is the newest Heathkit Hi-Fi Amplifier at the lowest price ever quoted for a complete Williamson Type Amplifier circuit. The W-4 Model has been designed for single chassis construction, and only for the new Chicago Transformer Company Model B0-13 "super range" high fidelity output transformer. This transformer, a new development in the Hi-Fi field, is being offered at substantial saving over transformers of comparable quality. It is outstanding in performance and on the basis of our tests, we find it equal in every respect to transformers used in the W-2 and W-3 Heathkit series.

LOW PRICES:

Through utilization of a single chassis with resultant economy obtained through elimination of duplicate sheet metal fabrication, connecting cables, plugs, sockets, and a new Chicago "super range" output transformer, a 20% price reduction has been made possible without sacrificing kit quality.

COMPONENTS:

The new Heathkit W-4 uses the same heavy duty power transformer and choke. It has all of the features of previous models including individual jacks and a wire wound control to balance the output tubes—plastic high quality capacitors and the exact circuitry previously utilized in Williamson Type Amplifiers. Intermodulation distortion and harmonic distortion are both at the same low level as in the W-2 and W-3 models.

CONSTRUCTION:

Here is the opportunity for even the economy minded Hi-Fi enthusiast to enjoy all of the advantages offered through Hi-Fi reproduction of fine recorded music. Simplified step-by-step Construction Manual completely eliminates necessity of electronic knowledge or special equipment. Assemble this Amplifier in a few pleasant hours.

Rugged, heavy duty,
single chassis con-
struction.

Output impedances
4, 8, and 16 ohms.



Standard
brand com-
ponents used,
no sacrifice of
quality.

Lowest price high quality
Williamson Type Ampli-
fier ever offered.

Send for
free booklet
"High
Fidelity
Especially
For You."

COMBINATIONS AVAILABLE

W-4M with Chicago "super-range" trans-
former only. Single chassis main amplifier
and power supply. Shipping **\$39.75**
weight 28 lbs. Express only

COMBINATION W-4 with Chicago
"super-range" transformer only includes
single chassis main amplifier and power sup-
ply with WA-P2 preamplifier **\$59.50**
kit. Shpg. wt. 35 lbs. Express only

NEW Heathkit 20 WATT High Fidelity AMPLIFIER KIT

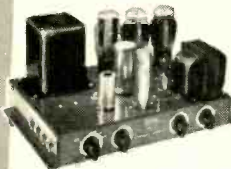

MODEL A-9B

\$35⁵⁰

Shpg. Wt. 24 lbs.

In keeping with the progressive policy of the Heath Company, further improvement has been made in the already famous Heathkit High Fidelity 20 Watt Amplifier. Additional reserve power has been obtained by using a heavier power transformer. A new output transformer designed and manufactured especially for the Heath Company, now provides output impedances of 4, 8, 16 and 500 ohms. The harmonic distortion level will not exceed 1% at the rated output.

FEATURES:

Outstanding features of the Heathkit 20 watt Amplifier include frequency response of ± 1 db from 20 CPS to 20 KC. Separate (boost and cut) bass and treble tone controls. Four switch selected input jacks and a special hum balancing control. Flexibility is emphasized in the input circuits and proper equalization for all input devices is incorporated.

TUBE LINEUP:

12AX7 magnetic preamplifier and first audio amplifier. 12AU7 two stage amplifier with tone controls. 12AU7 voltage amplifier and phase splitter. Two 6L6 push-pull beam power output and 5U4G rectifier. The Heathkit Model A-9B is excellent for custom installation and is designed for outstanding service at a very reasonable cost.

Heathkit SIX WATT AMPLIFIER KIT



MODEL A-7B

\$15⁵⁰

Shpg. Wt. 10 lbs.

An outstanding value, this econom-
ically priced 5 watt Amplifier is
capable of performance expected
only in much more expensive units.
Only 2 or 3 watts output will ever
be used in normal home applications
and Model A-7B will be more than
adequate for this purpose.

SPECIFICATIONS:

Two switch selected inputs are avail-
able for crystal and ceramic phone
pickups, tuner, TV audio, tape re-
corder, and carbon type microphone.
Model A-7B features separate bass
and treble tone controls, push-pull
balanced output stages, output im-
pedances of 4, 8, and 15 ohms, and extremely wide frequency
range $\pm 1\frac{1}{2}$ db from 20 CPS to 20 KC. Not just a souped up AC-
DC job. Full wave rectification, transformer operated power
supply and good filtering, result in exceptionally low hum level.

MODEL A-7C

Provides a preamplifier stage and proper compensation for the
variable reluctance cartridge and low level microphone. \$17.50

Heathkit WILLIAMSON TYPE AMPLIFIER KIT

Here is the famous kit form Williamson Type high fidelity Amplifier that has de-
servedly earned highest praise from every strata of Hi-Fi music lovers. Virtually
distortionless, clean musical reproduction, full range frequency response, and more
than adequate power reserve.

OUTPUT TRANSFORMERS:

This outstanding Williamson Type Hi-Fidelity Amplifier is supplied with the famous
Acrosound TO-300 output transformer. This quality transformer features the pop-
ular "ultra-linear" output circuit for clean maximum power level. Separate chassis for amplifier
and power supply.

SPECIFICATIONS:

Frequency response within 1 db from 10 cycles to 100,000 cycles. Harmonic distortion at 5 watt
output less than .5% between 20 cycles and 20,000 cycles. IM distortion at 5 watts equivalent
output .5% using 60 and 3,000 cycles. Output impedances of 4, 8, or 16 ohms. Overall dimensions
for each unit 7" high x 5 $\frac{1}{2}$ " wide x 11 $\frac{1}{2}$ " long.

CONSTRUCTION MANUAL:

This fine kit is supplied with a completely detailed step-by-step Construction Manual and the
only effort required is the assembly and wiring of the pre-engineered kit. Even the complete
novice can successfully construct this Amplifier and have fun building it.

COMBINATIONS AVAILABLE:

W-3 Amplifier Kit (Includes Main Ampli-
fier with Acrosound Output Transformer,
Power Supply and WA-P2 Preamplifier.)
Shipping weight 37 lbs. **\$69.50**
Shipped express only

W-3M Amplifier Kit (Includes Main Am-
plifier with Acrosound Output Transformer
and Power Supply.) Shipping **\$49.75**
weight 29 lbs. Express only



HEATH company
BENTON HARBOR 20
MICHIGAN

Separate BFO oscillator tube and circuit.

Continuous coverage 550 KC—35 MC on 4 Bands.

Heathkit COMMUNICATIONS RECEIVER KIT



MODEL AR-2
\$25⁵⁰
(Less Cabinet)
Shpg. Wt. 12 lbs.

An excellent example of typical Heath Company ability to produce top quality kit merchandise at ridiculously low prices, is the AR-2 Communications Receiver. Here is a transformer operated all-wave receiver with all of the desired features and none of the disadvantages commonly encountered in so-called "economy sets."

Receiver employs high gain miniature tubes and IF transformers, chassis mounted 5½" PM speaker, headphone jack, slide rule dial with Ham Bands plainly identified, and easy tuning with direct planetary drive. Continuous frequency coverage from 550 KC to 35 MC on 4 Bands, with electrical bandspread tuning and logging scales. Other features are RF gain control with AGC on-off switch—phone-standby-CW panel switch—prewound coils in a shielded turret assembly and copper plated chassis and shielding.

Uses 12BE6 mixer-oscillator, 12BA6 IF amplifier, 12AV6 detector-first audio, 12A6 beam power output, 12BA6 BFO oscillator, and 5Y3 rectifier. A lettered control plate is provided for the cabinet of your choice or you can order the optional Heathkit cabinet featuring the full size aluminum panel.

Phone—standby—CW panel switch.

RF Gain control with AGC on-off switch.

Electrical bandspread tuning with logging scales.

RECEIVER CABINETS

Proxylin impregnated fabric covered plywood cabinet available for BR-2 and AR-2 receivers. Includes aluminum panel, flocked reinforced speaker grill and protective rubber feet.

For BR-2 Receiver, Cabinet 91-9
Shipping weight 5 lbs. **\$4.50**

AR-2 Receiver, Cabinet 91-10
Shipping weight 5 lbs. **\$4.50**

Heathkit FM TUNER KIT

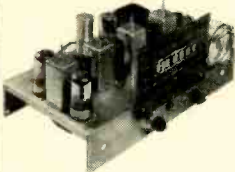

MODEL FM-2

\$22⁵⁰

Shpg. Wt. 8 lbs.

Here is an FM Tuner that can be operated with your Hi-Fi Amplifier or through the "phono" section of the ordinary radio. Completely AC operated to eliminate problems usually encountered in "economy type" AC-DC tuner circuits. Features 8 tube circuit with separate mixer and oscillator, 3 double tuned IF stages followed by a limiter discriminator providing maximum sensitivity and selectivity across the full FM frequency band of 88 MC to 108 MC. The tuning unit is factory assembled and adjusted, thus eliminating tedious critical "front end" alignment problems. The attractive slide rule dial and vernier tuning combine to make the Heathkit FM-2 Tuner simple to operate.

Heathkit BROADCAST BAND RECEIVER KIT



MODEL BR-2

\$17⁵⁰

(Less Cabinet)
Shpg. Wt. 10 lbs.

The Model BR-2 Broadcast Band Receiver is designed especially for the beginner without any sacrifice of quality. This receiver features a transformer operated power supply, high gain miniature tubes, sharply tuned IF transformers, new rod type built-in antenna, and a trouble-free planetary tuning system. Exceptional performance with unusually high sensitivity, good selectivity, and excellent tone quality from the 5½" PM chassis mounted speaker. Can be used either as a receiver, tuner, or phono amplifier. Uses 12BE6 mixer-oscillator, 12BA6 IF amplifier, 12AV6 detector, 12A6 beam power output, and 5Y3 rectifier.

HEATH COMPANY • Benton Harbor 20, Mich.

ORDER BLANK



MAIL YOUR ORDER TODAY TO THE
HEATH COMPANY
BENTON HARBOR 20,
MICHIGAN

WALNUT 5-1175

From _____

SHIP VIA

- Parcel Post
- Express
- Freight
- Best Way

(PLEASE PRINT)

QUANTITY	ITEM	MODEL NO.	PRICE

Enclosed find () check () money order for
Please ship C.O.D. () postage enclosed for _____ pounds.

On Express orders do not include transportation charges—they will be collected by the express agency at time of delivery.

ON PARCEL POST ORDERS insure postage for weight shown.

ORDERS FROM CANADA and APO's must include full remittance.

TELEVISION

(Continued from page 74)
exactly the same type? And why, when a new .005- μ f capacitor was installed, did the picture disappear again?

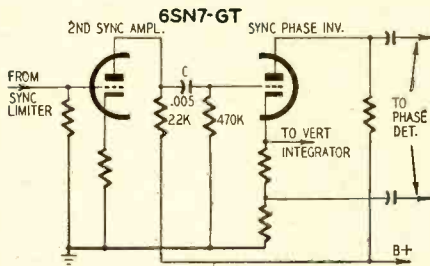

If you can answer these questions you deserve the \$64!

(Mr. Anglado's problem was referred to Dave Gnessin of Transvision, Inc. Here, in substance, is Mr. Gnessin's analysis of the problem. Have you a better guess?)

The .005- μ f capacitor couples the plate of the second sync amplifier to the grid of the sync phase inverter. All sync signals pass through it. If this capacitor was shorted or leaky—this can happen in the best of sets—it would put B plus on the phase-inverter grid, blocking that section of the tube and removing sync action while the tube was in its socket. Removing the tube stops the blocking action, and cuts out some of the sync amplification.

But the Transvision model A chassis has an exceptionally high-gain sync system. There are two stages—the first sync amplifier and the sync limiter—ahead of the 6SN7 that caused the trouble here. Thus even with our problem 6SN7 out of its socket, enough high-level sync could leak across the socket and wiring capacitance to trigger the horizontal and vertical oscillators for normal action.

Now as to why the set wouldn't work after the .005- μ f capacitor was replaced with a new one—presumably good: The grid of the original 6SN7 may have been contaminated with oxide pulled off the cathode by the positive grid voltage leaking through the defective capacitor, or the tube may have become gassy from the same cause. This would effectively short out the entire sync circuit at this point if the original tube was put back—even with a new capacitor.—Editor) END

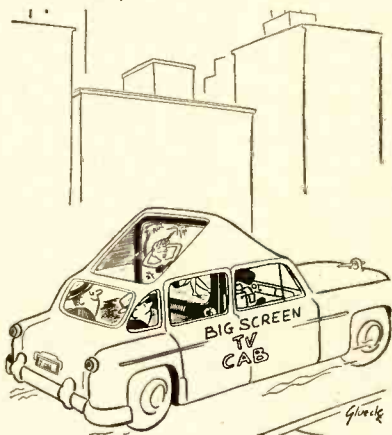

SEPTEMBER, 1954

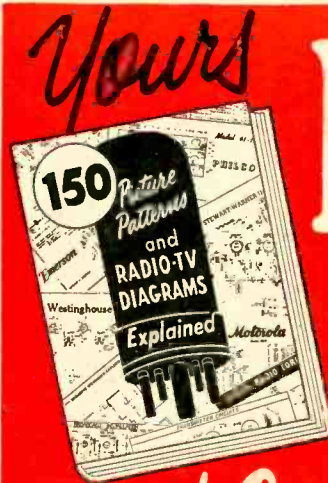

Yours FREE!

"Applied Practical Radio-Television"

Yes, you get this big, new 1954 book, "150 Radio-Television Picture Patterns and Diagrams Explained", absolutely FREE! Just off the press! Gives complete 11 x 22" Schematic Diagrams on leading models Radio and Television Sets. Easy-to-read, large 8½ x 11" pages, with full instructions on how to read and use the diagrams. A "must" in every Radio and Television serviceman's repair kit. You get this valuable book as a FREE Gift for asking to see Coyne's great new 6-book set, "Applied Practical Radio-Television"!

At Last! Money-Making "Know-How" on Transistors, Color TV and Servicing

Coyne's great new 6-volume set gives you all the answers to servicing problems—quickly! For basic "know-how" that is easy to understand, you'll find everything you want in volumes 1 to 5 which contain over 5000 practical facts and data. They cover every step from principles to installing, servicing, trouble-shooting and aligning all types of radio and TV sets. So up-to-date it includes COLOR TV and UHF, adapters, converters. Also covers latest data on TRANSISTORS.

Extra! 802-Page Television

Cyclopedia Included

And then, for speedy on-the-job use, you get Volume 6—the famous Coyne TELEVISION CYCLOPEDIA. It answers today's television problems on servicing, alignment, installation and others. In easy-to-find ABC order, cross indexed. Use this 6-Volume TV-RADIO LIBRARY free for 7 days; get valuable Servicing Book ABSOLUTELY FREE!

SEND NO MONEY! Just mail coupon for 6-volume set on 7 days free trial. We'll include book of 150 TV-Radio Patterns & Diagrams. If you keep the set, pay \$2 in 7 days and \$2 per month until \$22.50 plus postage is paid. (Cash price \$20.95). Or you can return the library at our expense in 7 days and owe nothing. **YOU BE THE JUDGE.** Either way, the book of TV-Radio Patterns is yours FREE to keep! Offer is limited. Act NOW!

COYNE
ELECTRICAL SCHOOL
500 So. Paulina Street
Dept. 94-T1, Chicago 12, Ill.

This Big Valuable Book Given
Just For Examining
Coyne's New 6-Volume Set

ON 7 DAY
FREE TRIAL!



OVER 2500 PAGES OF
RADIO & TELEVISION FACTS

Vol. 1 — Application of Television-Radio Principles; 300 pages — resonance, tuning, amplifiers, oscillators, etc.

Vol. 2 — Radio, Television & FM Receivers; 403 pages—rectifiers, high frequency, short wave, FM, antennas.

Vol. 3 — Radio-Television Circuits; 366 pages—power tubes, decoupling, distortion, photo-tubes, phase inverters, etc.

Vol. 4 — Latest Instruments For Servicing; 343 pages—all types of testing instruments; their use in service work.

Vol. 5 — TV Servicing & Trouble Shooting Manual; 400 pages—servicing of all TV sets, UHF, boosters, color TV printed in 4 colors, transistors, etc.

PLUS TV CYCLOPEDIA
Quick answers to all TV problems in A-B-C order 802 pages, illustrated; hundreds of facts on servicing, UHF, transistors, installation, alignment, much more.

FREE BOOK—FREE TRIAL COUPON!

COYNE ELECTRICAL SCHOOL, Dept. 94-T1
500 S. Paulina St., Chicago 12, Ill.

YES! Send 6-volume "Applied Practical Radio-Television" for 7 days FREE TRIAL per your offer. Include TV-Radio Patterns & Diagram Book FREE.

Name Age.....

Address

City Zone..... State.....

Where Employed

Check here if you want library sent COD. You pay postman \$20.95 plus COD postage on delivery. 7-day money-back guarantee.

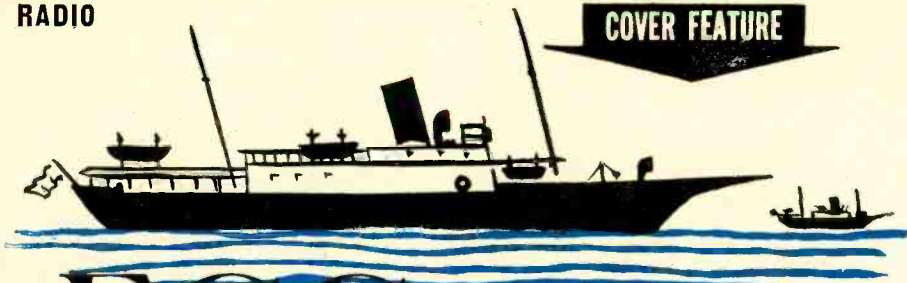

FCC BOOSTS MARINE RADIO

*Government regulation supplies
buffer for off-season slump* By **ELBERT ROBBERSON**

SERVICE technicians in the marine radio business have had extra business thrown their way by a couple of recent FCC rulings. Section 8.351 (d) of the Regulations now requires all small-boat radiotelephone licensees to certify that 2nd-harmonic radiation of the vessel's transmitter at the intership frequency of 2738 kc is 40 db below the unmodulated carrier level before being permitted to use that frequency. This is a technical requirement which other services have had to meet for years.

All that is needed is a fairly civilized transmitter circuit, proper adjusted. The "kicker" is that many phones (even from "name" manufacturers) use transmitter circuits that are definitely uncivilized. Taming these transmitters makes a good slack-season project, and will put a lot of boats back on 2738 kc that the regulation has crowded onto the groaning 2638-kc intership channel. Here is how to do it:

The main design features necessary to keep low-order harmonic radiation at a minimum have long been known: a high-Q output tank circuit; an antenna coupling means, preferably low-pass,

that permits optimum loading, and an antenna resonant at the fundamental frequency. Naturally, shielding and grounding are important, but it will be assumed that these features are adequate, since most of the interference is caused by current that gets out through the antenna wire. Let's see how the marine radiophones stack up.

The one-coil transmitter

The main reason for excessive 2nd-harmonic interference from marine radiotelephones is the unbelievable popularity of the circuit shown in Fig. 1-a. Without going into the auxiliary wiring such as control relays, this diagram shows the basic r.f. output circuit of at least 10 of the most popular makes of radiotelephones afloat.

This circuit consists of a pentode or beam-power r.f. amplifier, with a dual bandswitch tapping the tube plate circuit and the antenna onto different points of the tank coil for different marine-band frequencies (2110 to 2738 kc).

One-quarter wave in this band is in the neighborhood of 100 feet, so the average marine antenna of from 18 to 50 feet acts like a capacitor. Tapping it onto different turns therefore changes the resonant frequency of the tank. The tube also acts as a capacitor, so it also has a tuning effect. Both adjustments are juggled to tune both circuits match impedances, and vary the coupling.

Fig. 1-a contains several very bad design features: The plate tank cannot help but have very low Q, with a total effective capacitance across it of from only 100 to 200 $\mu\mu\text{f}$, and with the antenna resistance directly connected. Antenna loading is usually a bad compromise between several possible adjustments: The antenna often must be tapped across a major portion of the coil for the plate circuit to approach resonance, and in this position, loading is so heavy that downward modulation often results. The antenna is usually connected through a capacitor, which naturally offers less impedance to the

fundamental. Add to these the fact that the tank circuit is actually in the form of a high-pass filter, and that a short antenna favors harmonics, and it is no wonder a lot of messy signals exist.

At first glance, this type of transmitter may look like a hopeless case. But the owner may have an investment of from \$250 to \$1,500 in one of these clunkers, so even a piece of junk is worth salvaging. Fortunately, modifications necessary to bring the set up to modern standards are not too extensive or expensive.

A modification that conforms to acceptable engineering practice in all respects and which should reduce harmonic radiation to the required amount is shown in Fig. 1-b.

Both diagrams show shunt plate feed. However, some of the offending transmitters use series feed, with the d.c. plate voltage fed directly through the tank coil. For safety, as well as to ease harmonic reduction, these outfits should be changed to use shunt feed.

Only three components must now be added: Tank-capacitor C1, antenna coupling capacitor C2, and antenna resonating coil L2. These will be discussed later.

A high-Q tank circuit is one of the most potent means of harmonic reduction in an r.f. amplifier. This calls for a fairly high tank capacitance. With the approximately 5,000-ohm plate resistance of the 6L6 and 807 tubes, commonly used in the marine telephone band, a capacitance of 500 $\mu\mu\text{f}$ will give an operating Q of about 12, which approaches optimum. Although it is contrary to usual amateur, broadcasting, and up-to-date commercial practice, the tank capacitance can remain fixed at this value, with tank tuning adjustments made by the original plate-coil clips.

Output capacitor C2 provides a coupling means which by itself will attenuate harmonics. While the value on the diagram is .002 μf , the exact value for each installation (because of varying antenna resistance) must be determined on the job. Provision therefore should be made for varying this

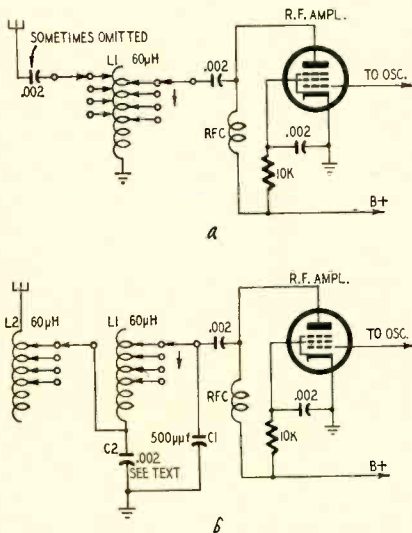
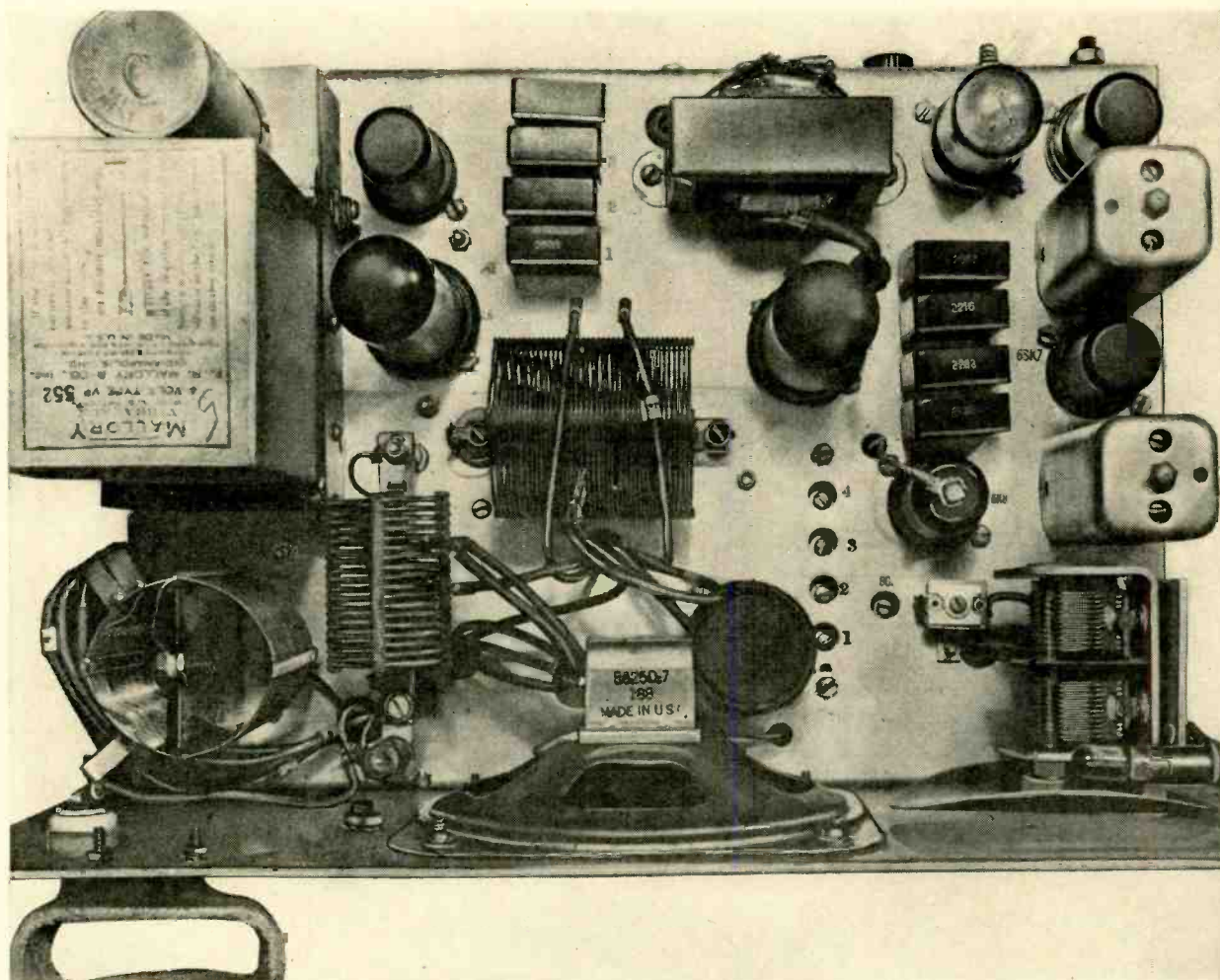

Fig. 1-a—Basic r.f. output circuit.
Fig. 1-b—Output-circuit modification.



Chassis of typical small-boat radiotelephone.

capacitance from .0015 to .0025. A variable capacitor or a set of fixed 100- μ f capacitors will serve this purpose.

Less capacitance increases antenna coupling and raises tube plate current at tank resonance; more capacitance decreases coupling and lowers operating plate current. A value of capacitance should be used for C2 which will load the tube to its proper plate current when both the tank and antenna are resonant. Once determined, this value will remain the same on all channels, so no further change will be required. Both capacitors should be high-grade mica or zero-coefficient ceramic rated for at least 2,500 volts, or peak plate voltage, if this is higher.

The tank circuit is now in the form of a low-pass filter.

If the antenna were $\frac{1}{4}$ -wavelength long, it could be connected directly between L1 and C2. However, very few boats can carry the 85 to 111 feet of antenna required, so a loading coil is almost invariably used. The coil is tapped onto for the different channels by Johnson coil clips and flexible leads connected to the original antenna switching wafer in the band-switch.

The antenna loading coil should be chosen for high Q, consistent with reasonable dimensions, and should be

mounted so there is no magnetic or capacitive coupling to the tank circuit.

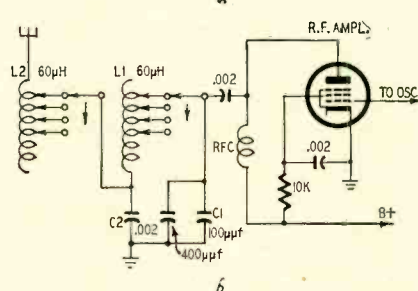
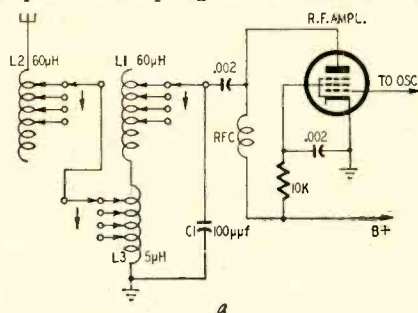

Fig. 2-a — An improved circuit design.
Fig. 2-b — Tank capacitance increased.

Six inches of B & W No. 3907-1 tinned coil stock should provide sufficient inductance to resonate the smallest antenna afloat. However, a heavier coil will give better antenna efficiency.

Two- and three-coil transmitters

Radiotelephones of later and better design have concentrated on the circuit form of Fig. 2-a. Sometimes the tank inductance is composed of one coil, with antenna coupling provided by tapping onto a few turns at the bottom of the coil, or by a link. The circuit shown, with a small 1-inch diameter coil, L3, of about 5 μ H at the bottom of the main coil, permits a finer degree of coupling adjustment because of its lower inductance per turn.

Although this circuit looks almost like the improved system of Fig. 1-b, a couple of defects exist that in some instances may result in objectionable harmonic radiation.

The first defect is the small tank capacitance used in most equipment, a capacitance of around 100 μ f. This practice comes from competition between manufacturers, each trying to have the highest carrier output. With lower than the proper value of capacitance, tank-coil heat loss is low, resulting in slightly higher output. The trouble is that harmonic output is also higher.

The combination of too small a tank capacitor and close antenna coupling can increase harmonic radiation beyond the danger point, even though the same transmitter, properly adjusted, may

WHOA, Mr. Serviceman!

DON'T JUST REPLACE—

MODERNIZE

with wide-range, high-compliance

SONOTONE

TITONE
CERAMIC CARTRIDGES



Always install a Sonotone, the original ceramic cartridge—your customers will love you for it. It will start them on the road to high-fidelity—and additional new business for you!

Write for free Sonotone manual today!

New Sonotone Phonograph Modernization Manual includes an up-to-date cross reference and phonograph model index, fully explains how to use Sonotone Ceramic Cartridges. Send coupon below for your free copy, now!

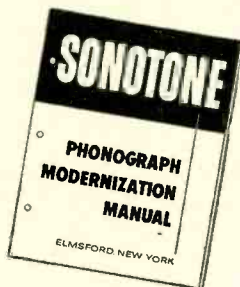

ELECTRONIC APPLICATIONS DIVISION

SONOTONE CORPORATION

Elmsford, New York

SONOTONE CORPORATION
Elmsford, N.Y.

Dept. E

Please send me a free copy of the Sonotone Phonograph Modernization Manual

Name _____

Address _____

City _____ State _____

RADIO

pass inspection with a good safety margin.

Two safety measures are apparent: Increase the value of the tank capacitance to about 500 μf and decouple the antenna to a point just below that which gives maximum output. Some marine transmitters may then over-modulate, but this can easily be eliminated by reducing mike sensitivity or a.f. gain.

To be absolutely safe, the extra coil, L3, can be removed. Then the same system can be used for coupling the antenna as was shown in the case of the one-coil transmitter. This is shown in Fig. 2-b, together with a 400- μf auxiliary capacitor, required to bring tank capacitance to 500 μf , which is not a bit too large.

Pi-network tank circuit

A telephone transmitter which has almost all of the characteristics for lawful operation—but not quite, in every instance—is the kind using a pi-network output circuit feeding an antenna directly. As mentioned previously, this arrangement will suffice for self-resonant antennas; or it would be perfectly satisfactory with a flat transmission line or other purely resistive load.

But the usual marine antenna is shorter than the resonant length and therefore highly reactive, as well as susceptible to harmonic currents. Using part of the tank coil to cancel antenna reactance (as is necessary in this case) has the effect of coupling the antenna directly into the tank, since the same turns of wire act to resonate both the tube circuit and the antenna. Thus a supposedly low-pass harmonic-suppressing circuit can give as much trouble as any other.

The solution is simply to add a separate antenna-resonating coil as shown in the previous examples. The network will then be working into the proper resistive load. Of course the tank capacitance must still be checked, to make sure it is large enough for reasonable operating Q.

Filters and traps

Besides the pi-network or low-pass filter shown in the previous circuits, there are other forms which under certain conditions may be used. Simplest examples are the parallel- and series-tuned wavetraps which have long been used to knock out receiver interference. However, it is extremely important not to look on traps as a cure-all. Marine-radio transmitting conditions are greatly different from those of broadcast or television. The kind of trap that will kill off spurious signals in a receiver may succeed too well in the marine radiophone—and kill off not only the harmonic but often the carrier as well.

In fact, the only advantage to the conventional wavetrap is that it can be connected in the transmitter antenna lead without digging into the equip-

CREI prepares you quickly for success in

The future is in your hands!

The signs are plain as to the future of the trained men in the electronics industry. It is a tremendous industry, and—at the *present time* there are more jobs than there are trained men to fill them. But—when there's a choice between a trained and untrained applicant, the trained man will get the job. Your biggest problem is to decide on—and begin the best possible training program.

**CREI Home Study : . . .
The Quick Way to Get There.**



Since 1927, CREI has given thousands of ambitious young men the technical knowledge that leads to more money and security. The time-tested CREI procedure can help *you*, too—if you really want to be helped. CREI lessons are prepared by experts in easy-to-understand form. There is a course of instruction geared to the field in which you want to specialize. You study at *your* convenience, at *your* rate of speed. Your CREI instructors guide you carefully through the material, and grade your written work personally (not by machine).

Industry Recognizes CREI Training.

CREI courses are prepared, and taught with an eye to the needs and demands of industry, so your CREI diploma can open many doors for you. Countless CREI graduates now enjoy important, good-paying positions with America's most important companies. Many famous organizations have arranged CREI group training for their radio-electronics-television personnel. To name a few: All America Cables and Radio, Inc.; Canadian Aviation Electronics, Ltd.; Canadian Broadcasting Corporation; Columbia Broadcasting System; Canadian Marconi Company; Hoffman Radio Corporation; Machlett Laboratories; Glenn L. Martin Company; Magnavox Company; Pan American Airways, Atlantic Division; Radio Corporation of America, RCA Victor Division; Technical Appliance Corporation; Trans-Canada Air Lines; United Air Lines. Their choice for training of their own personnel is a good cue for *your* choice of a school.



Benefits Felt Right Away.

Almost immediately, you feel the benefits of CREI training. Your employer, when informed of your step toward advancement (only at your request), is certain to take new interest in you and in your future. What you learn in CREI Home Study can start helping you do a better job immediately.



CAPITOL RADIO ENGINEERING INSTITUTE

An Accredited Technical Institute • Founded in 1927

3224 16th Street, N.W.

Washington 10, D. C.

MAIL THIS POSTAGE-FREE POSTCARD TODAY

Please send me your **FREE** illustrated booklet

"YOUR FUTURE IN THE NEW WORLD OF ELECTRONICS"

I understand there is no obligation whatever.

CAPITOL RADIO ENGINEERING INSTITUTE
Dept. 149-A, 3224 16th St., N.W., Washington 10, D. C.

Send booklet "Your Future in the New World of Electronics" and course outline.

CHECK FIELD OF GREATEST INTEREST

- TV, FM & Advanced AM Servicing
- Practical Radio Engineering
- Broadcast Radio Engineering (AM, FM, TV)
- Practical Television Engineering
- Aeronautical Radio Engineering

Name

Street

City Zone State

Check Residence School Veteran

- BROADCASTING
- TELEVISION
- MANUFACTURING
- COMMUNICATIONS
- SERVICING
- AERONAUTICAL ELECTRONICS

CREI also offers Resident Instruction

at the same high technical level—day or night, in Washington, D. C. New classes start once a month. If this instruction meets your requirements, check the coupon for Residence School catalog.

INFORMATION FOR VETERANS

If you were discharged after June 27, 1950—let the new G. I. Bill of Rights help you obtain resident instruction. Check the coupon for full information.

Get this fact-packed booklet today. It's free.

Called "Your Future in the New World of Electronics," this free illustrated booklet gives you the latest picture of the growth and future of the gigantic electronics world. It includes a complete outline of the courses CREI offers (except Television and FM Servicing) together with all the facts you need to judge and compare. Take 2 minutes to send for this booklet right now. We'll promptly send your copy. The rest—your future—is up to you.

See Our Ad On The Next Page





*The data that Launched
Thousands of Careers
is yours FREE to show*

**HOW YOU CAN BE SUCCESSFUL
IN RADIO-TV-ELECTRONICS**

Send for Your Booklet Today!

YOU CAN PLOD ALONG for years, getting a paltry increase now and then, enjoying little security, finding your work dull and drab.

Then something happens. Things look up. You become more confident. Your earnings rise. You feel more important.

"Luck," some may say.

"Contacts," others may suggest.

But in your heart, you will know the answer: "Training." And it all may have started the moment you filled out a coupon requesting a copy of a free booklet named "Your Future in the New World of Electronics." From this data you get knowledge of where you stand in Electronics. Tremendous expansion leaves this gigantic industry pleading for trained men. Top manufacturers sold billions of dollars worth of electronic merchandise in 1953. By 1960, the radio-electronics industry should do no less than 10 billion dollars per year, not counting military orders.

Today there are over 97,000 radio-equipped police cars; an even larger number of taxis are radio equipped (at least 87,000); 32,000 civilian planes have radio; 35,000

American ships have radio.

Today there are over 120,000,000 radios in use. There are 28,000,000 TV sets and 381 TV stations in operation. Color TV is coming into its own. Countless positions must be filled—in development, research, design, production, testing and inspection, manufacture, broadcasting, telecasting and servicing. To fill these posts, trained men are needed—men who somewhere along the line take time to improve their knowledge, their skills. Men who, today, perhaps, take two minutes to send for a booklet.

"Your Future in the New World of Electronics" shows you how CREI Home Study leads the way to greater earnings through the inviting opportunities described above.

However, CREI does not promise you a "snap." With an accredited technical school such as this, you must *study* to convert your ambition into technical knowledge you can sell in the fabulous Electronics market.

Since its founding in 1927, CREI has provided thousands of professional radio men with technical educations. During World War

II CREI trained thousands for the Armed Services. Leading firms choose CREI courses for group training in electronics, at company expense, among them United Air Lines, Canadian Broadcasting Corporation, Trans-Canada Airlines, Sears, Roebuck and Co., Bendix Products Division, All-American Cables and Radio, Inc., and RCA Victor Division.

CREI courses are prepared by recognized experts, in a practical, easily understood manner. You get the benefit of time-tested materials, under the personal supervision of a CREI Staff Instructor, who *knows* and *teaches* you what industry wants. This is accomplished on your own time, during hours selected by you, and controlled by your own will power. This complete training is the reason that graduates find their CREI diplomas keys-to-success in Radio, TV and Electronics. CREI alumni hold top positions in America's leading firms. At your service is the CREI Placement Bureau, which finds positions for advanced students and graduates. Although CREI does not guarantee jobs, requests for personnel far exceed current supply.

Now is the time of decision for you. Luck will not propel you forward unless it finds you trained. Contacts won't budge you an inch unless you have the skill to back them up. The answer is: Technical Training . . . and willingness to learn. Together they will bring you increased earnings in this new Age the Electronics. Fill out the postage-free reply card and mail it now. We'll promptly send you your free copy of "Your Future in the New World of Electronics." The rest—your future—is up to you.

1st Class
Permit No. 288-R
Sec. 34.9 P.L.R.
Washington, D. C.

BUSINESS REPLY CARD
No Postage Stamp Necessary If Mailed In United States

3¢ Postage Will Be Paid By
CAPITOL RADIO ENGINEERING INSTITUTE
3224 16th Street, N.W.
Washington 10, D. C.

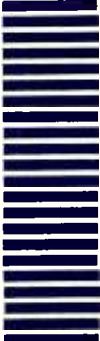

**MAIL THIS
POSTAGE-FREE
POSTCARD TODAY**

RADIO

ment. But even a good antenna trap may reduce signal power.

The care with which filters must be applied to antenna circuits is governed by the fact that the radiation resistance of the average small-boat antenna is very low. For example, a typical 18-foot antenna has a radiation resistance of only 1 ohm. A wavetraps built according to receiver standards would have much more resistance, and even one carefully constructed of high-grade commercial small-coil stock cannot equal this figure. Thus, if there were no other losses, more than half of the transmitter power would be lost in the trap!

The forms of traps which might be used in antennas are shown in Fig. 3. All of them are tuned to the 2nd harmonic. First is the familiar parallel trap (Fig. 3-a), which is effective,

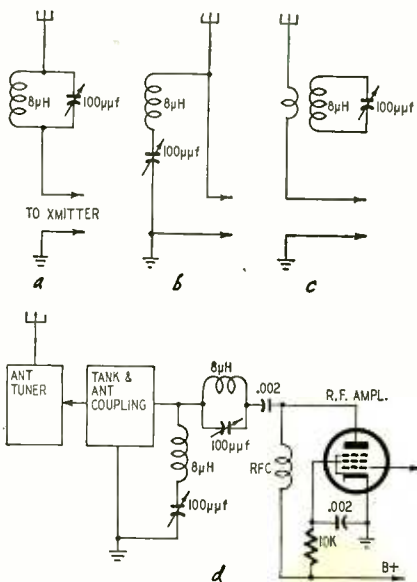

Fig. 3—Various types of antenna traps.

provided the antenna is long enough to have a radiation resistance much greater than the resistance of the trap. Fig. 3-b shows a series trap sometimes recommended, but which presents a shunt reactance to the antenna, which acts the same as a low-grade short circuit. Fig. 3-c shows a superior form of parallel-tuned trap which removes most of the harmful extra coil resistance from the antenna circuit.

Because all of them are likely to upset short-antenna performance, wavetraps should not be used indiscriminately. If they *must* be used, one or both of the connections shown in Fig. 3-d is recommended. Resistances in the tube plate circuit are not as critical as in the antenna, and the main effect plate traps will have is the introduction of a small reactance in the circuit which is easily canceled by the tank tuning control.

To be effective, traps must be physically small and preferably shielded, or located so their circulating currents cannot be coupled back into the antenna. For the 2nd harmonic of 2738 kc, a variable capacitor of 100 μf and

8 MASTERPIECES

LONG-PLAYING 33 $\frac{1}{3}$ R.P.M. HIGH-FIDELITY

NO STRINGS ATTACHED!

Without obligating yourself to buy another record, you can enjoy all advantages of trial membership.

\$1.00

Long
Playing

NOW YOU can get a real start on a complete record collection. You get ALL EIGHT masterpieces—complete to the last note—for only \$1.00. NOT \$1 each, but \$1 for ALL EIGHT!

Of course, this price bears no relation to the value of the recordings. Even for TWENTY times that amount, you could not buy these masterpieces in recordings of equal quality.

Why We Make This Amazing Offer

We were FORCED to make this "give-away" offer . . . for only by putting our recordings in your hands can we convince you how extraordinary their tonal quality is. Performed by internationally-renowned orchestras, conductors, and soloists. Custom-pressed on the purest vinyl plastic. Reproduced with a fidelity of tone which encompasses the entire range of human hearing . . . 50 to 15,000 cycles!

HOW CLUB OPERATES: As a trial member, you are not obligated to ever buy another record from us. You do, however, have the right to try—free of charge—any of the Society's monthly selections which interest you. You receive prior notice of these. You pay nothing in advance. And you are not obligated to keep those you try . . . even after you have played them and read the interesting music notes which accompany each selection. You pay only for those which—after having tried them—you decide you really want to own. And for these, you pay only the low member's price of \$1.50 per long-playing disc, embodying on the average about 40 minutes of music by the great masters. A saving of about $\frac{2}{3}$ off the usual retail price!

Think how much beauty and serenity these recordings will add to your life—at a trifling cost. Think what a cultural advantage your children will gain by having great music as an everyday inspiration.

Mail Coupon Now

We obviously cannot keep "handing out" such magnificent long-playing recordings indefinitely. Production capacity limits the membership rolls; once filled the offer has to be withdrawn. So avoid disappointment. Rush coupon with a dollar today. *The Musical Masterpiece Society, Inc., Dept. 529, 43 West 61st Street, New York 23, N. Y.*

Not \$1 each, but \$1 for all 8!

SCHUBERT

Symphony No. 8
(The "Unfinished"),
Zurich Tonhalle Orch.
Otto Ackermann, Conducting

BETHOVEN

The Ruins of Athens
(March and Choir),
Netherlands Philharmonic
Choir and Orch.,
Walter Goehr, Conducting

BRAHMS

Academic Festival Overture,
Utrecht Symphony
Paul Hupperts, Conducting

MOZART

Piano Concerto in E Flat, K 107
Artur Balsam, piano,
Winterthur Symphony Orch.,
Otto Ackermann, Conducting

BACH

Tocatta and Fugue in D Minor,
A. Schreiner; Organ of the
Tabernacle, Salt Lake City

WAGNER

Die Meistersinger, Prelude, Act 1,
Zurich Tonhalle Orch.,
Otto Ackermann, Conducting

DUKAS

Sorcerer's Apprentice,
Utrecht Symphony,
Paul Hupperts, Conducting

MOUSSORGSKY

Night on Bald Mountain,
Netherlands Philharmonic
Walter Goehr, Conducting

FREE "Music in Your Home" by Olin Downes

Mail coupon at once to receive, FREE, fascinating brochure by dean of American music critics. A guide to the valuable program notes and musical annotations which come free with every selection.



The Musical Masterpiece Society, Inc. Dept. 529
43 West 61st Street, New York 23, N. Y.

ALL 8 MASTERPIECES—\$1.00

Here is my dollar in complete payment; please send me ALL 8 of the masterpieces listed above and enroll me as a trial member. Send me notice of future selections which I may try for 5 days without cost or obligation. For those future l.p. discs I decide to keep after I have tried them, I will pay only the special member's price of \$1.50 each, plus few cents shipping. I may cancel my trial membership at any time.

Name.....

Address.....

City.....State.....

In Canada address: 686 Bathurst St., Toronto 4, Ont.

Advanced Electronics

→ Engineers
and Physicists

to conduct classroom
and laboratory educational
programs involving
advanced systems work in
the fields of radar fire
control, electronic computers
and guided missiles.

Airborne electronics is the field where greatest advancements are being made, because of military emphasis. Developments in these highly active areas call for an increasing number of graduates in Electrical Engineering or Physics, with instruction experience in radar, radar fire control systems, electronic computers, and other military electronic devices and equipment.

At Hughes Research and Development Laboratories in Southern California engineers assigned to this program are members of the Technical Staff. As training engineers they conduct Hughes equipment maintenance and operation instruction within the Laboratories for both military personnel and beginning field engineers.

Prior to assignment, engineers participate in a technical training program to become familiar with latest Hughes equipment. After-hours graduate courses under Company sponsorship are available at nearby universities.

Scientific and Engineering Staff

→ Hughes

RESEARCH
AND DEVELOPMENT
LABORATORIES

Culver City, Los Angeles County, California

Assurance is required that relocation of applicant will not disrupt an urgent military project.

RADIO

an inductor of 8 μ h should be used. This amounts to about 1½ inches of a B & W No. 3015 Mininductor.

External circuits

A broadcast engineer can make sure that no outside wires or structures interfere with his antenna. However, his cousin installing radiophones on boats cannot. If there is one thing a boat has much of, it is yards and yards of wire hanging around. Some of these wires may be just the right length to resonate at a harmonic frequency. There have been cases where such wires, in the transmitter field, have radiated harmonics that would not have escaped via the regular antenna. They can get this harmful current either by induction or shock excitation. In installing equipment, keep this fact in mind so that offending circuits may be isolated, grounded, or broken with insulators. The resonant frequency of suspected wires can be measured with a grid-dip oscillator.

Another condition that may aggravate matters is supplying the grid of the r.f. output tube with too much grid drive. Not many marine radiophones suffer from this, but the possibility should be considered if other steps are not completely effective.

Measurements

Some phone transmitters are certified by their manufacturers to conform to the FCC rule. But in any event, it is necessary to make actual measurements of harmonic radiation as a final check, and a certification of this measurement is required by the FCC.

This work should be done with the equipment installed and tuned. It cannot safely be done on the bench, since both the transmitter adjustment and the antenna are important elements in forming the character of the output. The care which must be taken can be seen from the fact that a reduction of 40 db amounts to a harmonic power output of only one ten-thousandth of the carrier level.

A commercial field-strength meter would be ideal, but a communications receiver can be used. A check to determine the approximate level of the harmonic for preliminary job study can be made with the receiver's S meter. Each S point should amount to 6 db. However, for more accurate work leading to certification this calibration should be checked against a calibrated signal source, such as a laboratory-type signal generator.

By taking care of transmitter harmonic reducing modifications, and other radiotelephone refinements such as adding "deck-calling," and dual channel reception for the International Calling and Distress Frequency, 2182 kc, and by manufacturing antennas and other accessories (possible in any shop), service technicians in the marine radio business can make the otherwise quiet lay-up season very profitable. END

there's always
something
new
being developed
by Perma-Power



- NORMAL LINE VOLTS
 - 10 VOLTS INCREASE
 - 10 VOLTS DECREASE
- 300 WATTS**

List Price
\$6.75

Sold Through
Better Jobbers

manufactured by
Perma-Power COMPANY
Chicago 25, Ill.
Manufacturers of Electronic Equipment Since 1928

Export Scheel International, Inc.
4237 N. Lincoln, Chicago 13, Ill.

For "Wire-Wounds"...

Make Sure . . .

Make It Mallory

Take a look at Mallory's complete line, any time you've got a service job that calls for any kind of wire-wound resistors. There's a big selection of fixed and adjustable vitreous enamel resistors, controls and power rheostats, from which you can choose the exact type needed for just about any replacement.

Only the best in materials and manufacturing methods go into these resistors. They're made to give maximum heat dissipation . . . to take overloads in stride . . . to keep stable values throughout their long service life. All types are conservatively rated, and are available in a wide choice of values.

You can depend on Mallory wire-wound resistors for the same precision-built quality that has made Mallory components . . . capacitors, vibrators and controls . . . the leading choice of servicemen everywhere.



Fixed and adjustable vitreous enamel resistors—5 to 200 watts.

Wire-wound potentiometers and rheostats—2 to 500 watts.

P. R. MALLORY & CO. Inc.
MALLORY

CAPACITORS • CONTROLS • VIBRATORS • SWITCHES • RESISTORS
RECTIFIERS • POWER SUPPLIES • CONVERTERS • MERCURY BATTERIES
APPROVED PRECISION PRODUCTS

P. R. MALLORY & CO. Inc., INDIANAPOLIS 6, INDIANA

A MORE COMPACT BATTERY PORTABLE

By I. QUEEN
EDITORIAL ASSOCIATE

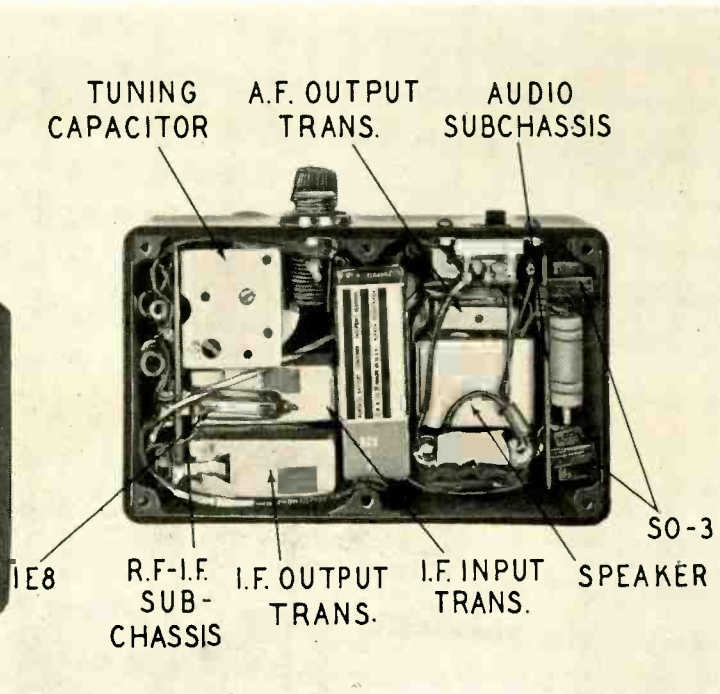
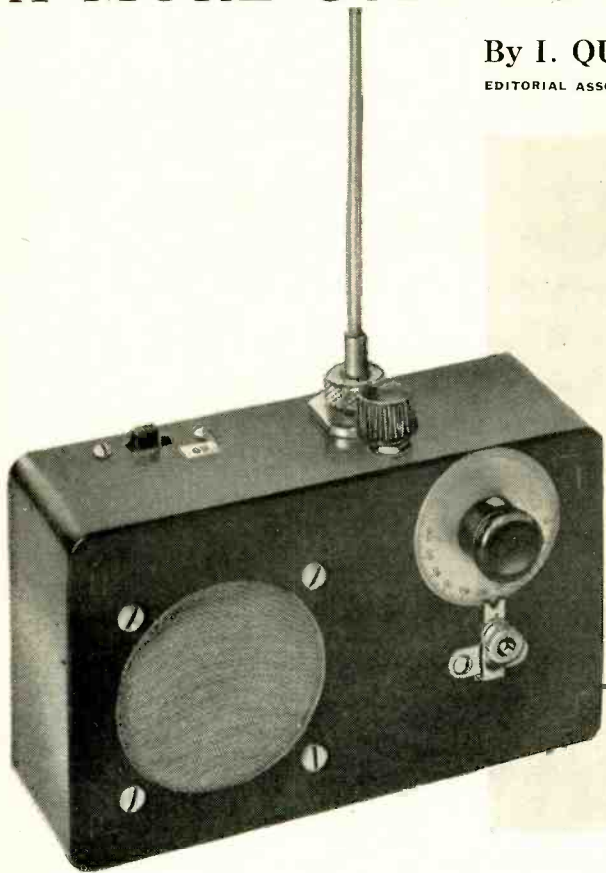

Left—The hybrid tube-transistor battery receiver. Fig 2, above—Rear view mentioned in Figs. 4 and 5.

LAST summer I constructed a super-heret portable, described in the March, 1954, issue. In building it, the smallest parts available (at reasonable prices) were used. Since then I located smaller components which made it possible to reduce the set size by more than half. The circuit is essentially the same as before (Fig. 1).

The entire set is now housed in a plastic case only 6 x 2 x 3 3/4 inches. The rear of the box is removable (Fig. 2). The speaker is mounted within the box and faces the front, and the r.f. and i.f. circuits are mounted on a bakelite sub-chassis 3 3/8 x 1 1/2 inches (Fig. 3). This portion, including up to the crystal detector, is visible at the left in the Fig. 2 photo.

The variable capacitor used in this layout has a maximum dimension of 1 3/4 inches, and is considerably smaller than the one used in last year's set. It is made by the Variable Condenser Corp. (Brooklyn, N.Y.) All wiring and small components are beneath the sub-chassis, an area 1/2 inch deep. The antenna coil is a Vari-Loopstick. I changed the oscillator coil to Meissner No. 14-1074 which has an iron core completely within the winding—there is no protruding screw. Anything larger than this coil won't fit into the allotted space.

All audio components are mounted on a bakelite subchassis approximately

1 x 3 inches (Fig. 4), which also appears at the right of the Fig. 2 photo. This subchassis is mounted on the speaker. I had to drill the iron bracket surrounding the speaker magnet to do this. To hold the components in place I also drilled holes in the subchassis and drew the leads of all components through. The output transformer is visible just above the speaker bracket. It is sold under a "PeeWee" trade name and is only about 1 inch long. The on-off slide switch is located just above the transformer. I used a double-throw unit, but a single-throw is adequate.

To fit into the smaller space, I made a change in the battery supply. A K20 (30 volts) is used for the B source. This can be seen standing up near the center of the radio. Since the B voltage was reduced, I connected each tube's

screen grid directly to B-plus, rather than through a dropping resistor. The A-battery is a Mallory type RM4000 which measures about 1 1/2 inches in diameter and is only 5/8 inch high. In Fig. 2 it is just behind the on-off switch. To guard against a possible short circuit, it is covered completely with masking tape so that only the soldered leads come through. I now use 4 pen-light cells for the transistor supply. They are taped together and rest beneath the speaker. The 20-ohm filament rheostat, LOCAL-DISTANT switch, 56,000-ohm biasing resistor, 15,000-ohm screen dropping resistor, and the phone and test jacks, which appeared in the original model, have been omitted from this model.

For improved reception I added a trimmer capacitor across the antenna

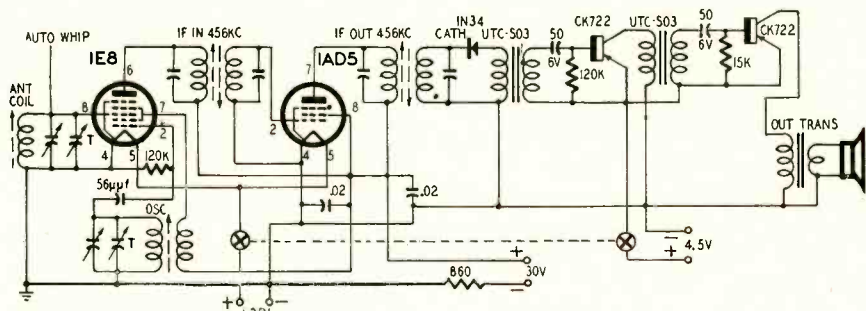

Fig. 1—Diagram of the March, 1954, receiver, modified as described in the text.

A NEW CONCEPT IN ROTATOR ENGINEERING!

Built-In Thrust Bearing—3200:1 Reduction Gear Train—Dynamic Braking!



ROTO KING



PIANO KEYBOARD TUNING!
Finger-tip control tuning. Precise antenna position indicated at all times. Magnificently styled console is a joy to behold.

Especially designed for fidelity reception of sharply directional color transmission. The JFD Roto King is the first ever engineered to overcome shortcomings of conventional rotator design which seriously affect the accuracy of antenna position and indication: ambiguity (error) and voltage fluctuation. The result is stop-watch tuning of antenna for fidelity reception of critically directional VHF, UHF and color signals especially.

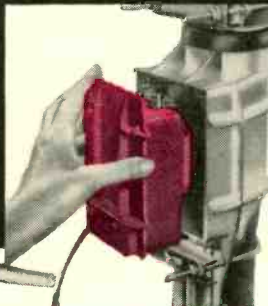
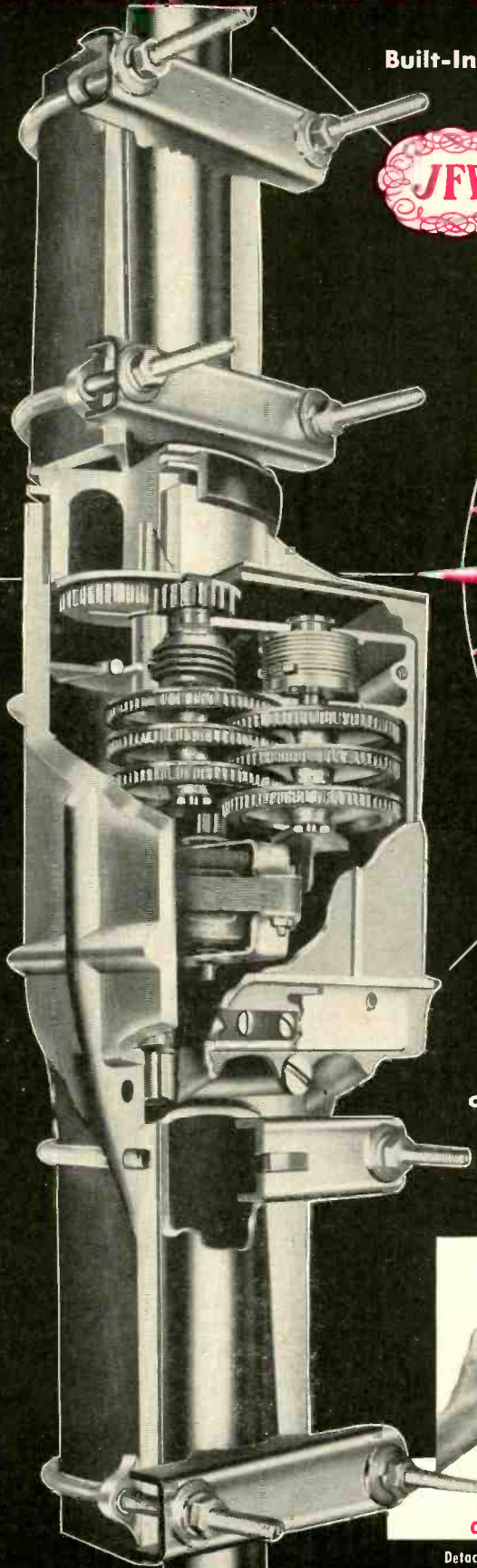

CARTRIDGE SERVICING!

Detachable power drive unit can be removed in seconds. No laborious dismantling of antenna.



STOP WATCH TUNING ACCURACY!

Ultra-sensitive control system accurate within 1/2 degree of desired position. Instant stop. No ambiguity. No drift or error.

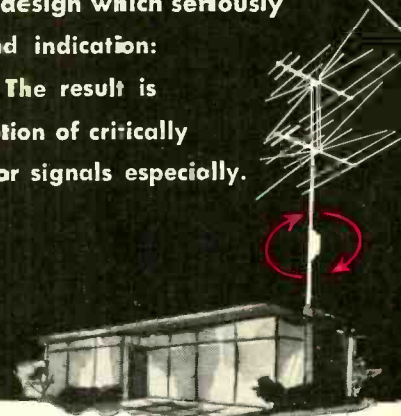

390 DEGREE ROTATION IN EITHER DIRECTION

Complete 390 degree revolution permits station selection beyond end of normal 360 degree traverse.



JFD MANUFACTURING CO., INC., BROOKLYN 4, NEW YORK

LOOK TO JFD FOR ENGINEERING LEADERSHIP

Export Division: 15 Moore St., N.Y.C.

WRITE FOR FORM NO. 289

**LEARN COLOR TV
THIS EASY WAY!**
Just off the Press!

ABC OF COLOR TV



H. G. Cisin's remarkable book takes the mystery out of Color TV. The only book which explains this fascinating new TV development in a simple down-to-earth manner. It actually translates the highly technical descriptions of research scientists into plain everyday language. Covers basic color principles, compatible color TV system, the color signal, color TV reception, plus practical pointers on color pix tubes, tests, servicing, antennas, etc. Just the info TV servicemen must have to cash in on this rapidly expanding new field. Profusely illustrated. **Only \$1**

**NEW! 1955 TV DOCTOR
ATTENTION: NOVICE SERVICEMEN!**



The new TV DOCTOR was written expressly for you by H. G. Cisin, noted TV educator and author. Mr. Cisin has trained thousands of TV technicians, many of them now holding important positions in television. His years of experience are embodied in this valuable book! TV DOCTOR contains just the info you need as you start in TV servicing. No theory, math or formulas, but full of practical information. Copyrighted Trouble Shooting Guide pin-points hundreds of TV troubles, enabling you to diagnose faults without previous experience. Method applies to all TV sets, old and new. Special chpt. on COLOR TV. Useful data about TV sets, tuners, antennas, lead-ins, interference, safety suggestions. Many clear illustrations. **Only \$1**

**FAMOUS "TV CONSULTANT"
TV Serviceman's Silent Partner**



New, easy-to-use way to solve toughest TV troubles. UHF sect. includes conversions, installations and servicing. Modern alignment methods shown by pictures, diagrams and simple directions, tell exactly what to do and how to do it. Practical pointers on use of all TV Test Instruments. Over 300 pix, raster and sound symptoms. Detailed directions tell where and how to find faulty parts. Over 135 RAPID CHECKS, many using pix tube as trouble locator. 125 illustr. of scope wave forms, diagrams, station pyms, when various defects—take mystery out of TV servicing. **NO THEORY—NO MATH—NO FORMULAS**—just practical service info, covering all types of TV sets. **Only \$2**

NEW! 1954 TV TUBE LOCATOR

Copyrighted TROUBLE INDICATING TUBE LOCATION GUIDES for over 3000 most popular models from Admiral to Zenith plus PIX TUBES used in each model! 1947 to 1953 models. A storehouse of valuable TV servicing info, priced very low for large volume sales. **Only \$1**

**NEW! Trouble Shooting PIX GUIDE
incl. TV TERMS Explained**

Sect. 1 is a fully illustrated GUIDE to oft-recurring pix faults. Causes and cures explained. Copyrighted "Trouble indicating illustration chart tells where troubles start in typical TV set—illustrations show resulting faulty TV pictures. Sect. 2 explains hundreds of TV terms in non-technical language. **Only \$1**

NEW! TV TROUBLE TRACER

Each vol. contains different copyrighted "Trouble Indicating TUBE LOCATION GUIDES" of over 500 most popular TV models. Vol. 1 has older sets, vol. 3 newest 1954 models. 40 common picture troubles illustrated, traced to source and cured. **Vols. 1, 2 & 3—Only 50c ea.**

H. G. CISIN, PUBLISHER

Order from your Jobber today, or if not stocked, write to
Harry G. Cisin, Dept. E-27
Amagansett, New York

Enclosed find \$.....Send
Color TV TV Pix Guide
TV Doctor TV Tracer, Vol. 1
TV Consultant TV Tracer, Vol. 2
TV Tube Locator TV Tracer, Vol. 3

Name
Address
City Zone State

RADIO

coil. Its knob can be seen near the antenna. The capacitor is a Johnson type 20M11, a very tiny unit. It tunes the antenna circuit to exact resonance and is especially helpful on weak stations. The antenna is a rod that tele-

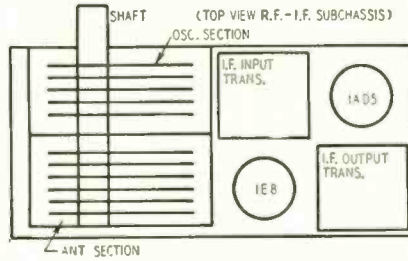

Fig. 3—Layout of r.f.-j.f. subchassis. scopes within a 1/4-inch hollow length of brass tubing. Total length when extended is 19 inches.

The speaker measures only 2 1/2 x 2 1/2 inches, yet is rugged and provides good tone quality. It is made by Oxford.

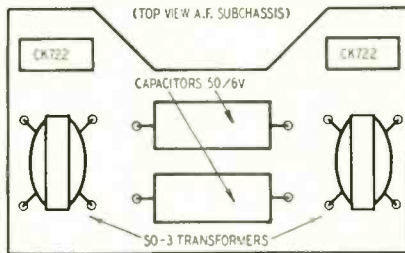

Fig. 4—Subchassis for audio components.

The radio, complete with rear cover, antenna and all parts and batteries, weighs only 2 pounds. It is a mere handful and can fit into an overcoat pocket. For carrying around, the antenna can be made removable as I have done.

The new, smaller version of the portable compares favorably with the original model. In a New York suburb it brings in all locals and dozens of out-of-town stations. I have picked up stations over 1,000 miles away with the 19-inch antenna, in the first floor of a building. The loudest stations (perhaps half a dozen) are audible and understandable 5 to 10 feet from the speaker. As with any portable, location has a considerable effect on performance. Within a steel skyscraper, results may be poorer than at street level outdoors. However, the receiver is so sensitive that it will pick up signals that have any reasonable strength. I heard stations even while riding the New York City subway, but the set must be held close to the ear, of course. (This little receiver was tried on the editor's desk at Plainfield, N.J.—roughly 20 miles west of New York City. Volume was low—the level was about right for comfortable listening at 2 feet from the speaker away in a quiet room. Pickup was surprising. With only its own short whip—on the second story of a wooden building—the first four stations heard were WBZ, Boston; WKBW, Buffalo; WINS, New York City, and WCAU, Philadelphia.) END

CLEAR TV PICTURE

119 MILES FROM STATION

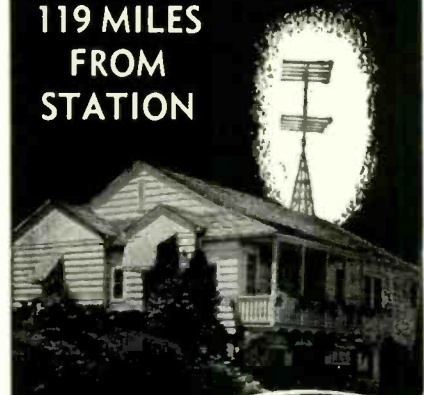

WITH A WINPOWER TOWER

Eliminate tower-mounting headaches. Insure better reception and fewer service calls with America's Lowest Cost TV Tower.

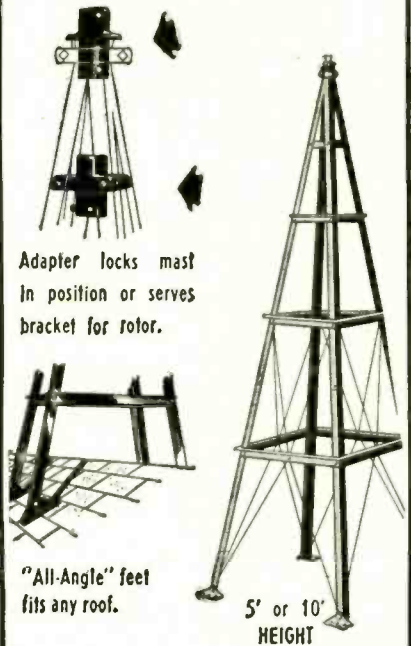

DEALERS PROFIT TWO WAYS

1. One man erects a neat, firmly supported antenna without special tools. Towers are light weight easy handling — individually packaged. Reduces objectionable guy wires.
2. Increase television sales with these permanent tower installations. Raise antennas to correct height with mast adapter. Reception goes up — service calls go down.

WRITE FOR PROFITABLE DEALER PLAN
WINPOWER
NEWTON, IOWA U.S.A.

**YOUR TICKET TO
THE GREATEST
"SHOW" ON EARTH!
...G-C SERVICE AIDS**

**FREE! New G-C Catalog
... get it today.**



Successful servicing of the greatest "show" on earth—television—calls for fast, economical, customer-pleasing performance. The G-C Service Aids shown here are typical of the almost four thousand items now available to help you do a better job . . . with greater volume, greater profits.

**G-C AMO MINIATURE
TUBE PULLER**
Prevents tube breakage,
burned fingers.
For 7-pin tubes
No. 5093—List \$1.80
For 9-pin tubes
No. 8106—List \$1.80



**G-C MINIATURE
TUBE PIN
STRAIGHTENER**
For 7-pin tubes
No. 5191, List \$1.25
For 9-pin tubes
No. 8105, List \$1.25



**G-C DUPLEX TUBE
PIN STRAIGHTENER**
Precision dies
straighten both 7- &
9-pin tubes.
No. 8655, List \$2.50



**G-C ALLEN-BRISTO
WRENCH KIT**
Twelve wrenches for
both hex and spline
screws.
No. 5028, List \$1.80



**G-C CABINET
REPAIR KIT**
Complete, in metal
box, full instruc-
tions.
No. 901, List \$7.50



**G-C TEST LEAD PLUG
INTERCHANGE KIT**
Interchanges alliga-
tor clips, banana
plugs, etc.
No. 7743, List \$3.25



**G-C DIAL CABLE
TOOL**
Aids in replacing
worn cables, dial
springs.
No. 5096, List \$0.85



**G-C TV & RADIO
DIAL CABLES**
Extra thin Nylon
.025" dia. Chemi-
cally treated, 25-ft.
spool. No. 75A-25,
List \$1.40.



**G-C 14-L
PHONO DRIVE**
Specially molded for
RCA 45-RPM, com-
plete.
No. 14-L, List \$1.00



**G-C 195 RCA TV
TUNER BELT**
For RCA series 8T,
8TC, 8TK, 9TC, etc.
No. 195, List \$0.50



**G-C NE-O-LITE
TESTER**
Handy for 60 v AC
to 550 v AC-DC.
No. 5100, List \$0.60



**G-C HIGH FIDELITY
RECORDING WIRE**
Finest quality stain-
less steel, with
leaders. 1-hr. spool.
No. 6171, List \$5.00



**G-C MASTER-TONE
RECORDING TAPE**
Plastic base, high
frequency response.
1270-ft. reel.
No. 5180, List \$5.50



**G-C NEW TV
SAF-T-RACK**
Holds any TV chas-
sis safely.
No. 8045, List \$5.45



**G-C SPEEDEX
WIRE STRIPPER**
New, fully automa-
tic, delayed action.
12 models.
No. 766, List \$8.25



**G-C TUBE & PARTS
EXTRACTOR**
Same as Signal
Corps TL-201.
No. 5092, List \$1.65



**G-C "TUX"
TOOL KIT**
Handy, flexible,
roomy.
No. 8943, List \$3.95



**G-C GENERAL
SKRATZ STIK**
Handy, fast on wal-
nut, mahogany, oak
cabinets.
No. 909, List \$0.60



G-C SILVER PRINT
Pure silver, for
touching up printed
circuits. 1 Troy oz.
No. 21-2, List \$7.75



**G-C RUF-KOAT
WRINKLE VARNISH**
Air dries; black,
gray or brown col-
or. 2 oz.; specify
color.
No. 60-2, List \$0.65

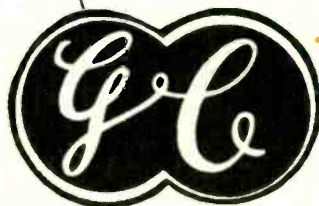

GENERAL CEMENT MFG. CO.

910 Taylor Avenue Rockford, Illinois

television
service

Quick Check on 3-way

Portable and Battery Radios

*Short cuts and techniques
for rapid servicing*

By FAIRBANKS TRYON

THERE are three general classes of portables: Those having a rectifier tube, those having dry-disk rectifiers, and those using batteries only. Typical examples of each are shown in the diagrams on this page.

The 3-way sets having a rectifier tube with 1.5- and 3-volt tubes in series, when switched to a.c.-d.c., are very similar to conventional a.c.-d.c. receivers with the exception of the d.c. filament voltage for the 1.5- and 3-volt tubes. Because of this the method of quick check will be somewhat different from that outlined in my article, "Shortcut Service on Radios," appearing in this magazine October, 1953.

Rectifier-tube type

Do not plug set in—all readings indicated in this article will be misleading if tubes and capacitors are allowed to warm up before testing. Turn switch to a.c.-d.c. operation and remove batteries; leave switches in this position for all except filament tests. Most of these tests can be made without removing the chassis on larger sets.

Now start your tests across the line plug. Most sets will read between 125 and 300 ohms. Any reading over 300 ohms indicates intermittent filament in rectifier, high resistance in switch contacts, a bad line cord or plug, or increased series resistor. Should the first reading be 300 ohms or over and then fall back in a few seconds to 200 or less, the chances are the tube filament is intermittent. To save time try a new rectifier tube and repeat the test—if reading is normal, perhaps you have repaired the set.

Any reading under 125 ohms across the plug, on any a.c.-d.c. set, except when 110-volt pilot lamps are used (in this case, remove lamp), indicates leaks or shorts, usually found to be in the power-supply filter. In this condition plugging set in will only cause more damage. You can test the filter on most sets without removing chassis: simply remove the rectifier tube and read from cathode prong on socket to line plug (only one side of plug will

work since removal of the tube will open the other lead). If you get any reading under 20,000 ohms, except a flash up scale which rapidly falls back to 20,000 (time required to drop back to 20,000 indicates condition of leakage), you have a defective filter capacitor. This test will not tell which filter is bad as the two are connected thru a resistor which in most cases is less than 20,000 ohms. When the chassis is out, if you remove the positive filter capacitor leads, you can tell which is bad. If both filters check O.K. try the same test at the points where the capacitors were connected. Readings at these points indicate leaking capacitors from plates or screens to B minus or ground. Checking along the B plus circuit to B minus, every resistor you go over from the rectifier cathode will increase the resistance reading unless you are getting nearer the leaky capacitor.

No reading across line plug indicates an open circuit. Hold prods on plug with one hand, grasp the line cord near the plug and bend the cord, also push in toward the plug. If needle flashes up and down scale the cord is broken at the plug. If no reading, bend the cord near the back of chassis. With needle points on prods pierce the cord near the plug; steady reading while bending cord will indicate cord broken at or in plug. No reading indicates an open switch, open series resistor, or open rectifier filament. Remove the rectifier tube and check all of its filament prongs (usually 3), an open between any two of them calls for a new tube. With the new tube in socket read across plug again. If the reading is normal you may have cleared up the defect. To check resistor or switches remove chassis and connect one prod to one prong of plug, with the other prod start at the line cord connection inside chassis which reads zero ohms. Check through all connections until you reach the other prong of the line plug (skip the switches if you like but check where it goes to the next tube or resistor).

To check the filament circuit of 1.5-volt tubes in series turn set on BAT-

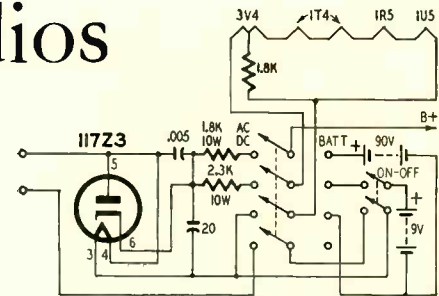
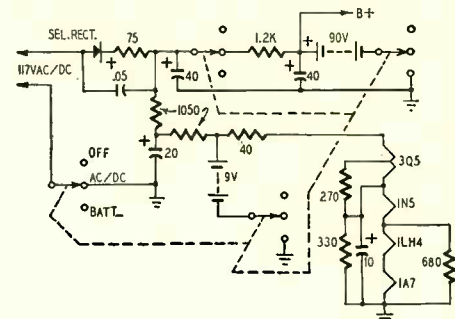
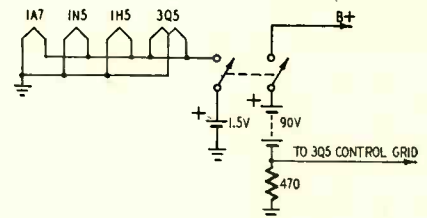

Plate and filament supply of 3-way portable using 117-volt rectifier.



Basic A- and B-battery supply circuit.



Schematic of an a.c.-d.c.-battery supply using a selenium rectifier.

and measure the resistance across the A battery prongs (removed from the battery of course). This reading should be about 7 ohms per A battery volt. In a 6-volt A-battery set the reading should be about 6 x 7 or 42 ohms. With a reading within 20% of that you can be assured all tube filaments and switches are O.K. Low readings indicate shorts and high readings or no readings indicate bad contacts, open circuits, etc. When shorts are indicated, look for stray strands and solder smears on battery plug, leaky or shorted filter capacitor from filament string to ground, and, where used, shorted resistors in filament string.

To check individual tube filaments, simply remove one tube at a time and check between its filament prongs. This is faster than the tube tester. A 1.5-volt tube will normally read about 10 ohms when first contacted, rising to

RADIO

about 20 ohms in a few seconds. If you have the diagram, check from each socket back to the A plug starting at either end of the string.

To check the filament A plus supply circuit when set is switched to AC-DC, remove the rectifier tube and check from cathode prong on socket to a filament prong on any one of the 1.5-volt tubes. A reading may not be obtainable on a low range; if not, try a higher range. The reading should be between 1,500 and 2,500 ohms when the hand stops drifting. The length of time required for the meter to slow to practically a stable condition is an indication of the quality of the A filter capacitor. Low readings indicate leaks or shorts, including cathode to filament shorts in rectifier tubes and changed value of resistors and B plus filter capacitors. The d.c. filament voltage for the battery tubes is taken from the B supply thru a series resistor (1,700 to 2,000 ohms) in most of these sets. High readings usually indicate altered resistors as this and filter-capacitor trouble are involved with most breakdowns in filament supply circuits.

All rules have exceptions. There are a great many if you include all of the prewar portables. The most common in recent models seems to be the power amplifier used on AC-DC on some sets, which switch it out and switch in the 3V4 or similar tube for battery use. On these sets the filament voltage for the other tubes is often obtained from the cathode of this power tube. This method places the filament string of 1½-volt tubes in parallel with the cathode resistor, which may be made up of 2 or 3 resistors. If a reading taken from this cathode to B minus is less than 30 ohms, check for leaks and shorts, especially cathode to filament in the power amplifier tube. The cathode of the rectifier tube supplies only B plus here and should be 20,000 ohms above B minus.

Dry disk rectifier type

This set is similar to the regular 3-way except for the power supply. Quick check with medium range of ohmmeter across line-cord plug (set turned on AC-DC, not plugged in). No reading is normal; reverse connections, and again no reading is normal. Any reading except a momentary flash indicates a shorted or leaky filter capacitor or dry disk. Go to the highest range on the meter and repeat the test, reversing connections as before. One of these readings should be at least 50 times the other. A dry disk rectifier having similar readings in both directions is bad. Compare the above tests with the readings across a new rectifier, where the difference will indicate condition of rectifier and filter capacitors.

Where the complaint on these sets is, "It works like it does with a weak battery; it comes on but fades away," suspect the rectifier. Even if it seems to check out, either take one lead off and

Stop scouting around for hard-to-find Can-Type Electrolytics!



Your Sangamo Jobber can supply all your "twist-tab" needs

Whether you need a hard-to-find capacitor for an obsolete set, or the latest size for any 1954 model, you can make just *one* stop for all electrolytic replacements—your Sangamo Jobber. He carries the most complete line of twist-tabs in the industry . . . 40 new types have been added in the past year alone . . . and he has them all IN STOCK!

Sangamo Type PL Electrolytics are used as original equipment by all major manufacturers—they are *exact* replacements—they assure long life and dependable performance at 85° C and under conditions of high surge voltages and extreme ripple currents.

Make your Sangamo Distributor your "headquarters" for all your capacitor needs. He can help you because he stocks . . .

Sangamo . . . still the most complete line in the industry



SANGAMO ELECTRIC COMPANY

MARION, ILLINOIS

SC54-1A

NEW PATENTED RADAR ANTENNA

OPENS NEW HORIZONS TO TV VIEWERS



ALL DIRECTIONS • ALL CHANNELS 2-83 COLOR AND BLACK-WHITE without ANY ROTORMOTOR

These are the reasons why the "Riviera" is by far the most powerful VHF antenna on the market today!

- Utilizes 16 elements 60" long, 1/2" diameter.
- Utilizes a specially designed, extra low loss four conductor air-dielectric POLYMICALENE transmission line which has up to 50% less loss when wet than the finest conventional transmission lines.
- The "Riviera" encompasses an electro-magnetic capture volume of well over 650 cubic feet, many times more than conventional antennas.
- The antenna works on the revolutionary principle that the approaching wave front is elliptically rather than horizontally polarized.
- The new specially designed 9 position electronic orientation switch, aside from changing directivity, maintains a consistently better impedance match over the entire UHF-VHF spectrum.
- The above features combine to give the "Riviera" antenna greater usable gain at the TV set antenna terminals than the best of any competitive antennas using rotor motors.

This new wonder antenna, called the "Riviera", is already making history. Beyond any question of a doubt, and on an unconditional money back guarantee, it will positively outperform in the field under actual installation conditions, any and all competitive antennas on the VHF channels, with or without rotor motors.

POLAR PATTERNS

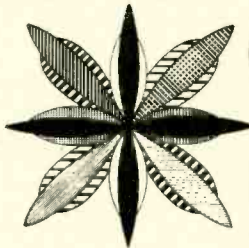

only
\$49.50
LIST PRICE

Price includes: Complete Stacked Array • Stacking Bore • 9 Position Switch • Switch-to-set Coupler • 2 Stand-offs, 7 1/2" • Complete Instructions

The polar directivity response patterns show the major lobes of the "Riviera" antenna on VHF. It shows the fullness of coverage in all directions of this remarkable, patented antenna as it is turned through each of the nine switch positions. Each degree of shading constitutes a different switch position. This excellent directivity response, which can be switched at will, plus the extremely high gains, clearly indicate why the Riviera is such a superior performer.

IN UHF-VHF DISTRICTS . . . USE
The NEW Super 60
100 MILES VHF • 60 MILES UHF

ALL CHANNEL ANTENNA CORP.

47-39 49th STREET, WOODSIDE 77, N. Y. EXETER 2-1336

RADIO

attach a new rectifier to this lead and the other end of the old rectifier; or, if you prefer, read the voltage output. The voltage will be about the same d.c. reading as the a.c. input from a single rectifier; double it if 2 rectifiers are used. In either of these cases you may have to wait for the fading to take place. When you are busy, the quickest way is to put the new one on and turn the set on (plugged in) and let it run. If it does not fade out in an hour or so perhaps that fixes it. Check the filter capacitors before you let it run because a shorted capacitor will damage the new rectifier.

Check the filter capacitors as on the sets with the rectifier tube, taking the readings from the screen and plate of the output-tube socket (tube removed). Bad line cords, tubes, and capacitors, together with the line and filter resistors cause about 95% of the breakdowns on these sets.

Battery sets

These sets are of 2 general classes: those in which the tubes are all in parallel, working on a 1.5-volt A battery; and those having tubes in series and operating on an A battery whose voltage is equal to the sum of all the tube filament voltages.

All radios must have a bias voltage, a negative voltage applied to various grids. Originally, on battery sets and some early electric sets this was supplied by a separate C battery—some sets still use it. This voltage is now obtained on practically all battery sets by resistors from grid to chassis or filament and by a resistor between B minus and chassis. Some exceptions occur in sets having tubes in series where sufficient voltage can be obtained at certain points along the filament string. In the latter case A minus and B minus may both be grounded direct to chassis.

Except for the source of bias voltage and resistance readings at the battery plug, battery sets are very much alike. On series-filament sets the resistance reading will be about 7 ohms per volt of A battery, taken from A plus to A minus on the plug. The reading from A minus to chassis (or ground) will be zero. That from B minus to chassis may also be zero or it may be 300 to 1,000 ohms. From B plus to chassis the resistance should be 20,000 ohms or more unless you have leaks or shorts; but under 2 megohms unless the filter capacitor or B minus-to-chassis resistor is open.

On the so called "1,000-hour battery sets" and 1.5-volt portables the resistance reading across the A battery prongs will be small—2 1/2 ohms or less, depending on the number of tubes (do not use meter delivering over 2 volts on this or any other test involving 1.5-volt tubes). The reading from A minus to chassis will be zero, and from A plus to chassis, 2 1/2 ohms or less. B minus will be 300 to 1,000 ohms from chassis, and B plus will be over 20,000 ohms but under 2 megohms.

EASY TO LEARN CODE TELEVISION

It is easy to learn or increase speed with an Instructograph Code Teacher. Affords the quickest and most practical method yet developed. For beginners or advanced students. Available tapes for beginner's alphabet to typical messages on all subjects. Speed range 5 to 40 W.P.M. Always ready—no QRM.



ENDORSED BY THOUSANDS!
The Instructograph Code Teacher literally takes the place of an operator-instructor and enables anyone to learn and master code without further assistance. Thousands of successful operators have "acquired the code" with the Instructograph System. Write today for convenient rental and purchase plans.

INSTRUCTOGRAPH COMPANY
4701 Sheridan Rd., Dept. RC, Chicago 40, Ill.

Big demand for graduates

B.S. DEGREE IN 27 MONTHS in radio including TV engineering—VHF, UHF, AM and FM. Students use over \$100,000 worth of equipment including 2 large commercial type transmitters in new TV lab. Intense specialized course includes strong basis in mathematics, science and advanced design in radio and TV.
Hundreds of young men each year are earning engineering degrees in this recognized institution. Start any quarter. Many earn a major part of expense in this industrial center. Low tuition. Competent instruction. Thorough, intense, practical program.
Also **B.S. DEGREE IN 27 MO.** in Aeronautical, Chemical, Civil, Electrical and Mechanical Engineering. G.I. Gov't approved. Enter Sept., Dec., March, June. Free catalog. **ENROLL NOW.**
INDIANA TECHNICAL COLLEGE
1794 E. Washington Blvd., Fort Wayne 2, Indiana

RADIO

Readings far different from these will indicate troubles already covered. No reading, or over 1,000 ohms from B minus to chassis, would indicate the resistor from B minus to chassis is burned out (this will occur every time B plus is shorted to chassis, so use your voltmeter to check voltage and leave the screw driver for the screws). The switch on battery sets usually turns on both A and B supplies, therefore if one voltage is present and the other is not, don't forget to check both sides of the switch.

Practically all tests herein can be made without removing the chassis; however where leaks or shorts are indicated, or open circuits exist within the chassis it will have to be removed before repair would be possible. The main purpose of this article is to save time that many service technicians have been wasting in removing the chassis only to find that the line cord was loose from the plug or a tube burned out.

It is not usually necessary to pull the chassis if the battery wires are out of the plug (and you don't need a diagram to replace them, because, with the above readings you can replace the plug in less time than you can find the diagram).

Just be sure that after identifying the wires you get them in the proper prongs. If you are not sure, hold the plug over the battery socket, or drawing of it, on top of the battery with the prongs down like they enter the socket and check your readings again. After you plug the battery in and turn the switch it is too late to learn that you put the B plus wire in the A plus prong. Look before you leap! END

NEW METAL LOCATOR



A compact metal detector that will distinguish between metallic iron and other metals such as gold and silver has been developed by Gardiner Electronics Co., Phoenix, Arizona. The unit contains only one tube, a 1R5, and 2 cells. When iron is detected, the earphone signal becomes louder; when other metals are detected, the signal decreases.

SEPTEMBER, 1954

OUTSTANDING for HIGH FIDELITY!

**BUY DIRECT
AND SAVE**

'PRE-FAB'

**COLLINS TUNERS
and
RECEIVERS**

AUDIO PRODUCTS CO.

NOW!

with AFC

Collins Audio Products Co. is an equal opportunity employer with Collins Radio Co.

Each Collins Tuner Kit is complete with punched chassis, tubes, power transformer, power supply components, hardware, dial assembly, tuning eye, knobs, wire, etc., as well as the completed sub-assemblies: FM tuning units, AM tuning units, IF amplifiers, etc., where applicable. All sub-assemblies wired, tested and aligned at the factory make Collins Pre-Fab Kits easy to assemble even without technical knowledge. The end result is a fine, high quality, high fidelity instrument at often less than half the cost because you helped make it and bought it direct from the factory.

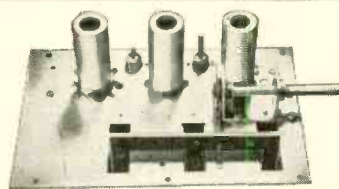

FMF-3 Tuning Unit

\$1525

with AFC \$18.75

The best for FM. The most sensitive and most selective type of "front end" on the market. 6 to 10 microvolts sensitivity. Image ratio 500 to 1. 6J6 tuned RF stage, 6AG5 converter, 6C4 oscillator. Permeability tuned, stable and drift-free. Chassis plate measures 6 1/2" x 4 1/2". In combination with the IF-6 amplifier, the highest order of sensitivity on FM can be attained. Tubes included as well as schematic and instructions. Draws 30 ma. Shipping weight FMF-3: 2 1/2 lbs. Dial available @ \$3.85.

IF-6 Amplifier

\$1975

6 Tubes. Shipping Wgt. 3 lbs.

FOR USERS OF COLLINS TUNERS:

Receive \$5.00 credit toward the new FMF-3A front end! Mail us your old front end with \$13.75 and we will send you the new, improved FMF-3A with AFC, or, remit the full amount of \$18.75 and when we receive your old unit in return a check will be mailed you for \$5.00.



AM-4 Tuning Unit

\$2450

Tops in AM superhet performance! A 3-gang tuning condenser gives 3 tuned stages with high sensitivity and selectivity. Assembly is completely wired, tested and aligned ready for immediate use. Frequency coverage 540 KC to 1650 KC at a sensitivity of 5 microvolts. Tubes 6BA6 RF amplifier; 6BE6 converter; 6BA6 IF amplifier and 6AT6 detector. Draws 30 ma @ 220 volts. Mounts on a chassis plate measuring 4" x 7 3/8". Shipping weight 2 1/2 lbs. Dial available at \$3.85.

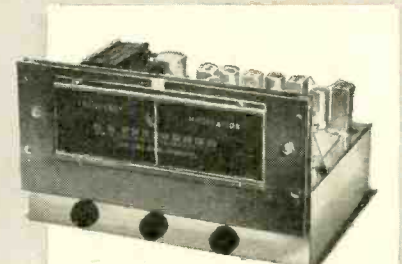

FM Tuner Kit

\$55

with AFC \$58.50

The FM-11 tuner is available in kit form with the IF Amplifier mounted in the chassis, wired and tested by us. You mount the completed RF Tuning Unit and power supply, then after some simple wiring, it's all set to operate. 11 tubes: 6J6 RF amp, 6AG5 converter, 6C4 oscillator, 6BA6 1st IF, (2) 6AU6 2nd and 3rd IF, (2) 6AU6 limiters, 6AL5 discriminator, 6AL7-GT double tuning eye, 5Y3-GT rectifier. Sensitivity 6 to 10 microvolts, less than 1/2 of 1% distortion, 20 to 20,000 cycle response with 2DB variation. Chassis dimensions: 12 1/2" wide, 8" deep, 7" high. Illustrated manual supplied. Shipping weight 14 lbs.



FM/AM Tuner Kit

\$7750

with AFC \$81.00

The original 15 tube deluxe FM/AM pre-fab kit redesigned on a smaller chassis. The tuner now measures 14" wide by 12" deep by 7 1/2" high. This attractive new front and dial assembly opens up new applications where space is at a premium. Kit includes everything necessary to put it into operation—punched chassis, tubes, wired and aligned components, power supply, hardware, etc. Kit comprises FMF-3 tuning unit, IF-6 amplifier, AM-4 AM tuning unit, magic eye assembly and complete instructions. All tubes included. Shipping weight 19 lbs.

**MAIL
COUPON
TODAY**

To: Collins Audio Products Co. Inc. RE-9
P.O. Box 368, Weerfield, N. J.
Tel. Weerfield 2-4390

FM Tuner Kit FM/AM Tuner Kit FMF-3 Tuning Unit
 with AFC with AFC with AFC
 IF-6 Amplifier AM-4 Tuning Unit

NAME

ADDRESS

CITY STATE

Amount for Kit \$ See weights, add shipping cost \$

Total amount enclosed \$ Check Money Order

WHEN YOU THINK OF TUNERS, THINK OF COLLINS AUDIO PRODUCTS

ELECTRONIC PHOTO-FLASH SYSTEM

Portable unit provides "strobe" light for flash photography

By L. B. HEDGE



Camera, master lamp, and power unit.

THE "electronic flash" or "strobe" light for flash photography has become in recent years the hallmark of the well-equipped photographer. The basic unit of this ultra-modern lighting system is the gas discharge tube developed by Dr. Edgerton for the observation and photography of moving objects (U.S. patent 2,478,902 filed in 1933 and issued in 1949). Improvements in the original system which made it possible to parallel several lamps (Edgerton patent 2,351,603, filed in 1941 and issued in 1944) brought the electronic-flash system into serious competition with the conventional flash bulb. Its advantages of long life, high speed and intensity, rapid sequence use, and near daylight quality (color temperature) have made it extremely popular in the flash-photography field. Popularity has made the electronic flash tube available at a reasonable price in a variety of types, and the simplicity of its power supply and control equipment make construction of a high-quality photo-flash system a simple job. The system described here was built largely from odds and ends from the junk box—it is nevertheless a high-quality instrument of great versatility and durability.

An electronic-flash system consists of three basic parts: a power supply, a lamp (one or more flash lamps), and a triggering or timing unit. In general, the choice of the type and number of lamps to be used will determine the

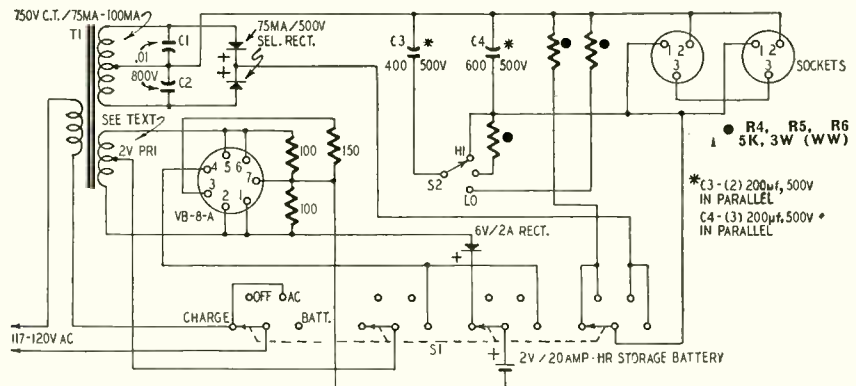

Fig. 1—Schematic diagram of the portable a.c.-battery power-supply unit.

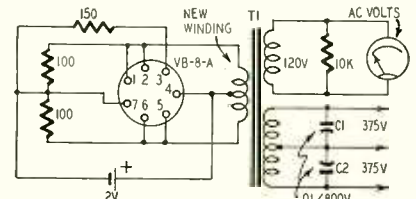
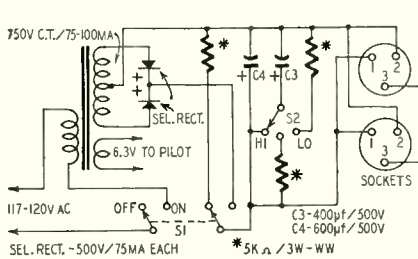

Fig. 2, left—A straight a.c. supply. Fig. 4, above—New winding checker.

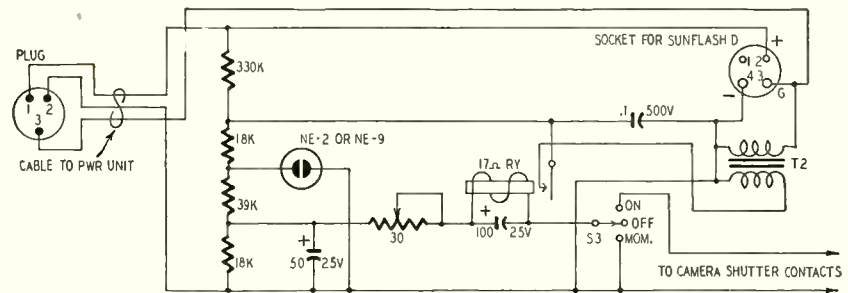

Fig. 3—Schematic of the master unit, used with the power supply of Fig. 1.

general form of the other units. Low-voltage (400–600 volts) tubes were selected for this unit for several reasons: 500-volt components are cheaper and more easily obtainable than the 2,000-or-more-volt components for a high-voltage system; the low voltage is safer, it requires less step-up in a battery-operated portable unit, and the flash time is longer with the low-voltage lamps—an advantage for most uses since the electronic flash crowds the

lower exposure limit of most films and tends to reduce the margin of emulsion speed (ASA speed index) available at normal exposure times.

The quantity of light (light intensity integrated over the flash duration time) produced by an electronic flash tube is directly proportional to the power dissipated in the flash tube during the flash. It is fixed by the power available in the power supply, and is limited by the power-handling capabilities of

the tube used. Low-voltage flash tubes are rated at from 100 to 300 watt-seconds maximum power dissipation, and will operate at 35 to 40% of this power with satisfactory efficiency. A 125-watt-second flash will give an exposure comparable to that of a *Press-40* flash bulb when used with *Plus-X* film. Two tubes flashed in parallel from the same power supply will each dissipate approximately 50% of the available power, and since only one will furnish the key light for the exposure, the guide number ($f\text{-stop} \times \text{distance from lamp to subject}$) will be about 75% of the full power value.

Power supply

Power for the electronic-flash system is provided by a bank of capacitors—500-volt electrolytics serve well and are economical in cost, weight, and space occupied. A capacitor will store, when fully charged, power equal to $\frac{1}{2}CV^2$ in watt-seconds when C is in microfarads, and V is the voltage across the charged capacitor in kilovolts. Thus a 200- μf capacitor charged to 500 volts stores power of $\frac{1}{2} \times 200 \times (0.5)^2 = 25$ watt-seconds. The same capacitor charged to 447 volts stores only 20 watt-seconds, indicating the importance of keeping the supply voltage up; for a given capacitor and lamp setup the flash guide number is proportional to the voltage across the capacitor.

From these basic considerations it is possible to plan an electronic-flash system to provide the lighting you require. The system described here uses a power pack of five 200- μf -500-volt capacitors (125 watt-seconds maximum power, guide number for *Plus-X* about 155 with 1 lamp, 110 with 2 lamps), with a reduced-power-switching arrangement to permit use of three of these capacitors (75 watt-seconds, *Plus-X* guide number

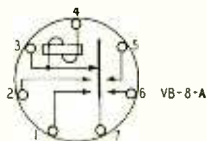

Fig. 5—Base connection of vibrator.

115 for 1 lamp) for close-up shots where an open diaphragm for soft-focus background is required. A light storage battery vibrator power pack to charge the capacitors was decided on since the system was to be used afoot and afield as well as in civilization. The power supply can be used with a 117-volt a.c. supply as a charging source, and has a built-in circuit for recharging the battery from the power line (Fig. 1). In an emergency it can be recharged from a car storage battery with a 2- or 3-ohm current-limiting resistor in series. If such versatility is not required a much simpler, lighter, and cheaper power supply is possible, such as the a.c. unit in Fig. 2.

The flash-lamp master unit (Fig. 3) with the lamp triggering unit included

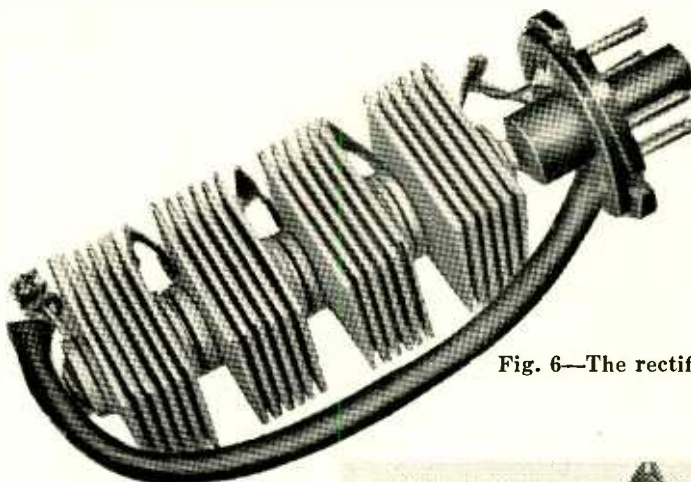

Fig. 6—The rectifier stack assembly.

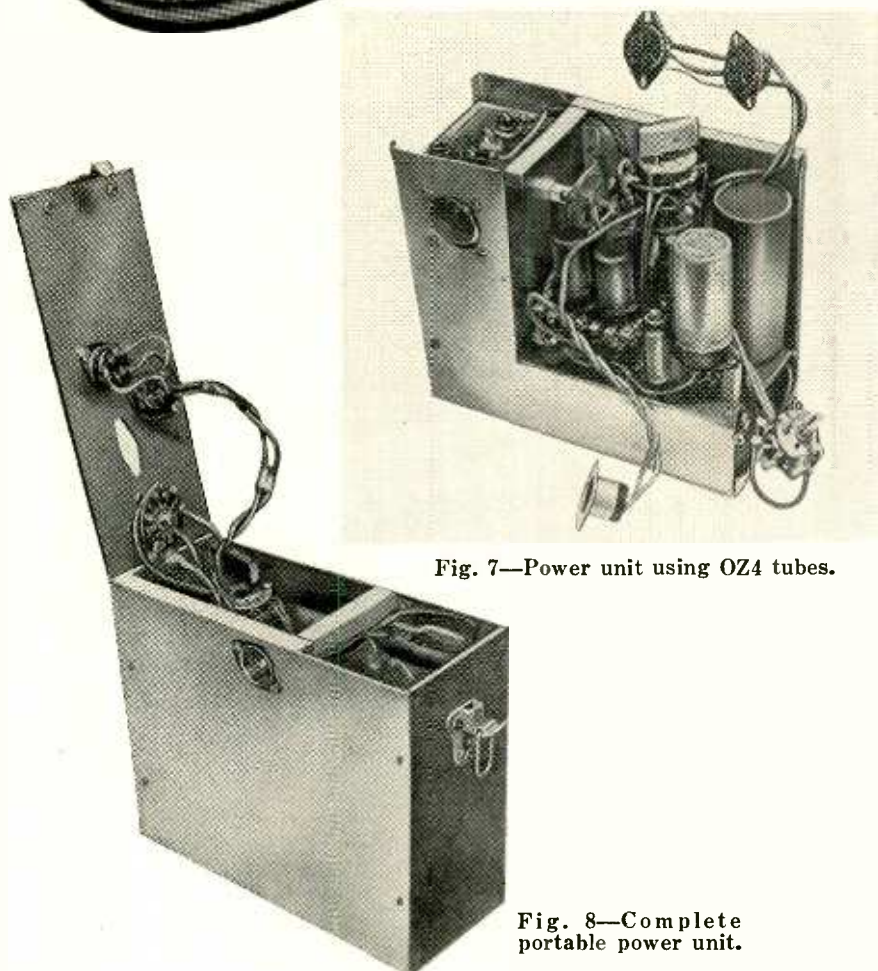

Fig. 7—Power unit using OZ4 tubes.

Fig. 8—Complete portable power unit.

will be essentially the same for any low-voltage electronic flash system. It includes a socket and reflector for the flash lamp, a voltage divider, and series of small capacitors to supply the triggering power, a relay and transformer for starting the triggering pulse and raising its voltage (the triggering pulse to the tube must be about 1,200 volts), connections to the power pack and camera shutter contacts, and a neon ready-light which glows when the voltage on the power-supply capacitor bank reaches a satisfactorily high value (about 475 volts). This sounds more complicated than it is: the whole thing can be put into a battery-flash-

light case if desired, or mounted in some equally small container of some other sort. The master units were built into surplus BC-366 jack boxes about $2\frac{1}{4} \times 3\frac{3}{4} \times 4\frac{1}{4}$ inches.

The one piece of "special" equipment used in my electronic-flash system is power transformer T1. It is rebuilt from a garden variety replacement power-supply unit with a 120-volt, 60-cycle primary, two filament secondary windings, and a 750-volt center-tapped high-voltage winding. The core was disassembled and the filament windings were removed (with turns carefully counted to determine the number of turns per volt used in the transformer

THE #630 TV RECEIVER remains unmatched for quality and performance • • • RCA designed and developed this set quality-wise *not* price-wise • • • The original 10" set retailed at \$375.00 • • • Subsequent TV sets serve to prove the sacrifice of quality for price • • • what better proof can there be of its superiority than the fact that it is the choice of TV engineers and TV technicians! Herewith we offer you—YOUR BEST BUYS IN TV!—All you pay is the price shown • • • Excise taxes have already been paid by us.

10% Extra Discount

on a Combination purchase of . . .

A KIT or any **CHASSIS**

with **CABINET** AND ANY SIZE **PICTURE TUBE**

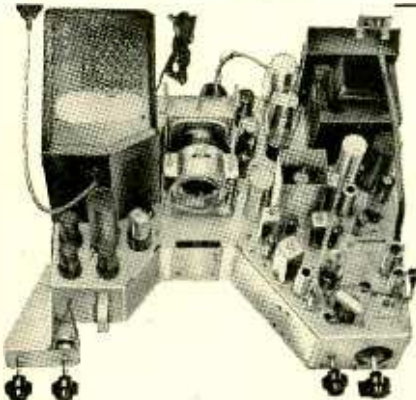

Build your own

**#630
Super Deluxe
TV CHASSIS**

with . . . U. H. F.

With a **#630 SUPER DELUXE 31-TUBE TV KIT** including your assigned U.H.F. Station • OPERATES 16" TO 24" PICTURE TUBES • Engineered in strict adherence to the genuine RCA #630 plus added features • FULL 4MC BANDWIDTH • CAS-CODE TUNER • COSINE DEFLECTION YOKE • LARGER POWER TRANSFORMER • KEYED AGC • 12" SPEAKER • UNIVERSAL MOUNTING BRACKETS • CONDENSERS and RESISTORS at rated capacities and tolerances. You receive a COMPLETE SET OF PARTS and TUBES, everything needed is included (less wire & solder). All I.F. Coils and Transformers are factory pre-aligned and tuned. You will enjoy building it with "LIFE-SIZE" easy to follow step-by-step ASSEMBLING INSTRUCTIONS" included with each KIT.

only . . . **\$119.44** (less CRT)

#630 SUPER DELUXE TV CHASSIS

with **U.H.F.** —Licensed under RCA patents

COMPLETE READY TO PLUG IN AND PLAY—Similar in characteristics and features to the TV KIT at left • Manufactured especially for us by Regal Electronics Corporation • No efforts or expense have been spared in workmanship or materials, to make this #630 SUPER DELUXE TV CHASSIS the Best obtainable for fringe areas, clarity and all-around performance. Customers report reception better than 200 miles. Each Set is factory aligned and air-tested • All parts carry the RMA three month guarantee • Our mass volume of business on this CHASSIS (numbering thousands of pleased customers) now makes it possible for us to reduce the price to.....

only **\$157.97** (less CRT)

#630 TV SPECIALS BY TECH-MASTER

27" GOLD MEDAL 2430-9 TV CHASSIS, Complete, ready to plug in and play, including your assigned U.H.F. station. **90° deflection, operates all 24" or 27" rectangular and 30" round picture tubes.** The last word in TV achievement • Ideal for wall or custom-cabinet mounting • Detailed technical data mailed on request, however with the knowledge that this CHASSIS is a 30-tube #630 with both TECH-MASTER'S and OUR guarantee, you need not hesitate sending your order in now.

\$262.50 (less CRT)

COMPLETE LINE OF #630 TECH-MASTERS

VHF entitles you to one UHF Station Free. UHF/VHF includes tuner for 82 channels.

	UHF/VHF	VHF
MODEL 2430: For picture tubes up to 24". Audio connection for optional use of external amplifier.	\$249.50	\$189.50
MODEL 2431: Same as 2430, but with True Fidelity Push-Pull audio amplifier.	259.59	199.50
MODEL 2430-9: For new 90° kinescopes. (24" rectangular, 27" and 30").	299.50	262.50
MODEL 1930: Similar to 2430 with slight modification including area control switch at rear of chassis and cadmium plated finish instead of nickel.	224.95	179.50
MODEL C-30: Designed for the utmost in Quality at an Economical price.	209.95	149.50

(All complete, ready to plug in. CRT not included)

DUMONT or SHELDON FINEST GUARANTEED PICTURE TUBE

MOST desirable 5 sizes—ALL RECTANGULAR • • • BRAND NEW in Factory Sealed Cartons—With a Full Year Guarantee

17" #17BP4A **\$29.63** | **20"** #20CP4B Aluminized **\$39.74** | **21"** #21EP4B Aluminized **\$44.68** | **24"** #24CP4A Aluminized **\$66.24** | **27"** #27EP4A Aluminized **\$82.57**

CUSTOM-BUILT CABINETS FOR #630 AND ALL OTHER TV SETS—from FACTORY to YOU

5 LEADING STYLES in genuine mahogany or walnut (blond 10% extra) • Ready drilled for any #630 TV chassis and cutout for any 14", 17", 19", 20" or 21" picture tube at no extras in price • Also supplied with undrilled knob panel for any other TV set • EVERYTHING NECESSARY for an easy perfect assembly is included • Each cabinet is delivered complete as pictured with mask, safety glass, mounting brackets, backcup, hardware and assembling instructions • Each cabinet is shipped in an air cushioned carton from FACTORY to YOU!

The VOGUE
Most Popular
Table Model



H-25", W-26", D-22"

\$39.89

The MANHATTAN
Style, Quality, Price



H-41", W-25", D-23"

\$59.37

MANHATTAN for 24" or 27" CRT
H-48 1/2", W-27 3/4", D-24" **\$86.22**

The MAYFAIR
Exquisitely modern, with an elegance of simplicity in styling.

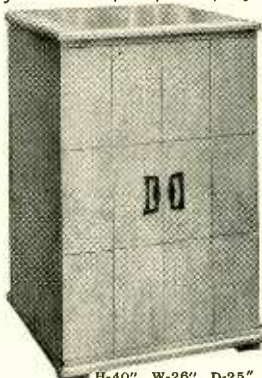

H-40", W-28", D-25"

\$98.56

The PLYMOUTH
Choice of Interior Decorators, truly superb in every detail.

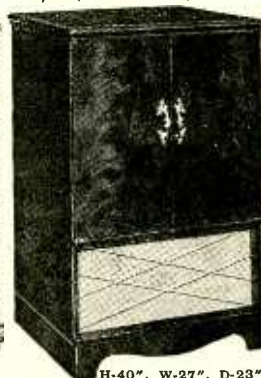

H-40", W-27", D-23"

\$105.48

The TOWN & COUNTRY
Patterned after the popular credenza. Available for all size picture tubes.

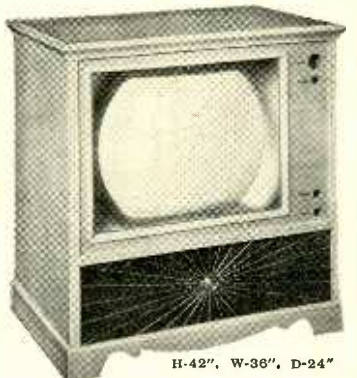

H-42", W-36", D-24"

\$109.62

For 14", 16", 17", 19", 20", 21", 24" or 27" C.R.T.'s

BROOKS RADIO & TV CORP., 84 Vesey St., Dept. A. New York 7, N.Y.

TELEPHONE
CORtland 7-2359

10% Extra Discount—On purchases amounting to \$50.00 or over on all items on this page

#630 TV PARTS...TOP QUALITY...LOW PRICES
FOR KIT BUILDERS, REPLACEMENTS AND EXPERIMENTERS

STANDARD CASCODE TUNER, incl. tubes	\$22.49
ESUTCHEON PLATE, for tuner.....	.69
COMPLETE SET OF KNOBS, incl. decals...	1.34
POWER TRANSFORMER, 255ma, 201T6...	9.97
VERTICAL OUTPUT TRANS., 204T2...	2.69
VERTICAL BLOCKING TRANS., 208T2...	1.32
HORIZONTAL OUTPUT TRANS., 211T1...	2.47
HORIZONTAL OUTPUT TRANS., 211T5...	3.98
FOCUS COIL, 247 ohms, 202D1...	2.29
FOCUS COIL, 470 ohms, 202D2...	3.42
DEFLECTION YOKE, 60", 201D1...	2.97
DEFLECTION YOKE, Cosine 70", 206D1...	3.98
SOUND DISCRIMINATOR TRANS., 203K1...	1.12
1st PIX I.F. TRANSFORMER, 202K2...	1.08
2nd PIX I.F. TRANSFORMER, 202K3...	1.08
1st & 2nd SOUND I.F. TRANS., 201K1...	1.02
HORIZONTAL DISCRIM. TRANS., 208T8...	1.49
FILTER CHOKE, 62 ohms.....	1.47
CATHODE TRAP COIL, 202K4...	1.08
WIDTH CONTROL COIL, keyed AGC IR4AG	.79
HORIZONTAL LINEARITY COIL, 201R3...	.39
3rd & 4th PIX COILS	.39
FILAMENT CHOKES	.09
VIDEO PEAKING COIL, 208L1...	.18
VIDEO PEAKING COIL, 203L2...	.18
VIDEO PEAKING COILS	.18
VIDEO PEAKING COILS	.18
ION TRAP BEAM BENDER, double 203D3...	.98
ION TRAP BEAM BENDER, single 203D1...	.79

PUNCHED CHASSIS PAN, cadmium plated	\$4.87
630-KIT, screws, nuts, rivets, washers....	1.69
HI VOLTAGE CAGE ASSEMBLY, complete	3.73
VOLTAGE DIVIDER SHIELD & COVER	1.79
ELECTROLYTIC COND. SUB-CHASSIS...	.94
SOUND DISCRIMINATOR SHIELD.....	.19
DEFLECTION YOKE BRACKET.....	.29
DEFLECTION YOKE MOUNTING HOOD...	.59
FOCUS COIL BRACKETS.....set	.49
CATHODE TRAP COIL SHIELD.....	.39
CHASSIS MOUNTING BRACKETS, set of 4	.44
BRIGHTNESS & HOLD CONTROL BRACKET	.59
WIDTH CONTROL BRACKET.....	.16
TUNER SHAFT BRACKET.....	.17
FUSE (.25 amp.) & HOLDER.....	.24
HV RECTIFIER, SOCKET ASSEMBLY, single	.79
HV RECTIFIER, SOCKET ASSEMBLY, double	1.37
TV 6" LINE CORD, with both plugs.....	.29
INTERLOCK SAFETY CONNECTOR (input)	.17
AGC BRACKET & SOCKET.....	.39
MINIATURE WAFER SOCKETS.....	.07
MINIATURE MOLDED SOCKETS.....	.12
OCTAL WAFER SOCKETS.....	.07
CATHODE RAY TUBE SOCKET, 18" leads	.39
HV KINESCOPE LEAD, with clip.....	.39
AUDIO OUTPUT TRANSFORMER (6K6)...	.69
8" PM SPEAKER, heavy alnico #5 magnet	3.97
12" PM SPEAKER, heavy alnico #5 magnet	6.94

Brooks LIFE-SIZE Edition
#630 TV KIT BUILDER-SET of INSTRUCTIONS
BUILDING YOUR OWN #630 TV CHASSIS is now simplified with this COMPLETE SET OF BUILDING & WIRING INSTRUCTIONS. Covers all #630's, from the RCA 16" SET to the latest SUPER DE LUXE 31-tube 16" to 24" RECEIVER. EVERYTHING AT A GLANCE—LAYOUT CHARTS show chassis and components in actual LIFE-SIZE with instructions alongside the illustrations.
INDISPENSABLE for BUILDING, CONVERTING or TROUBLE SHOOTING any #630 TV SET.

\$2.49 Postpaid
Popular priced at only...

THE NEW CASCODE TUNER
can now be installed in ANY TV set
"Brooks CASCODE MANUAL"
with easy to follow step-by-step instructions
only 50¢ Postpaid

- HINTS FOR BETTER PICTURES ON 630TV
- 630TV DIAGRAM WITH MODIFICATIONS
- ILLUSTRATED TV CONVERSION MANUAL
- PULSE KEYED AGC CIRCUIT DIAGRAM
- RMA RESISTOR & MICA CODE CHARTS

All for only **\$1.00** Postpaid

PULSE KEYED AGC KIT
Finest, most accurate and the easiest Kit to install in a #630 or in any other make TV receiver. Improves performance, and insures a steady picture on all channels.
COMPLETE SET OF PARTS \$4.59
Including 6AU6 tube & Instructions

VARIABLE CONTROLS

PICTURE & SOUND, 10k ohms 1 meg. & switch	1.14
VERTICAL & HORZ., 50k ohms 1 meg.....	1.04
BRIGHTNESS CONTROL, 50k ohms.....	.44
HORIZ. CENTERING, wirewound 20 ohms...	.57
HEIGHT CONTROL, 2.5 megohms.....	.48
VERTICAL LINEARITY, 5000 ohms.....	.44
VERTICAL CENTERING, wirewound, 20 ohms	.96
FOCUS CONTROL, wirewound, 1500 ohms...	.98
HORIZONTAL DRIVE, 20k ohms.....	.44

H. V. FILTER CONDENSERS—(Cartwheels)

15kv — 500 mmf.....	.67
20kv — 500 mmf.....	.79
30kv — 500 mmf.....	1.49

#630 PARTS in COMPLETE SETS

TV WIRE SOLDER KIT, for any Set.....	1.49
VIDEO AND I.F. KIT, 19 items.....	7.84
VARIABLE CONTROL KIT, 9 controls....	5.83
CARBON RESISTOR KIT, 107 resistors....	6.98
WIREWOUND RESISTOR KIT, 4 resistors...	2.31
BRACKET AND SHIELD KIT, 18 items....	8.63
ELECTROLYTIC CONDENSER KIT, 6 cond	7.37
TUBULAR CONDENSER KIT, 38 condensers	4.28
CERAMIC CONDENSER KIT, 28 condensers	3.37
MICA CONDENSER KIT, 11 condensers...	1.38
TERMINAL STRIP KIT, set of 30.....	.98
COMPLETE SET OF TUBES, 29 tubes.....	30.31

ELECTROLYTIC CONDENSERS—85°C

40/10/80 mfd—450/450/150 v.....	1.37
40/40/10 mfd—450/450/450 v.....	1.49
80/50 mfd—450/50 v.....	1.49
40/10/10 mfd—450/450/350 v.....	1.37
20/80 mfd—450/350 v.....	1.49
250/1000 mfd—10/6 v.....	.98

AM SUPER RADIO FOR #630 or other TV. Complete, ready to install w/tubes & instructions.



Lists for **\$24.95**

IT'S YOURS FOR ONLY \$7.89

#630 TV BASIC PARTS KITS

PUNCHED & DRILLED CHASSIS PAN BRACKET & SHIELD KIT (18 items)
VIDEO & I.F. KIT (19 items) All for only **\$39.49**

POWER TRANSFORMER #201T6
VERTICAL OUTPUT TRANSFORMER
VERTICAL BLOCKING TRANSFORMER
FLYBACK TRANSFORMER #211T5
FOCUS COIL, 470 ohms #202D2
COSINE DEFLECTION YOKE 70"

Including LIFE-SIZE TV BUILDER INSTRUCTIONS

UNIVERSAL Picture Tube MOUNTING BRACKETS

Fits All 12 1/2" to 21" picture tubes Complete—including band that holds picture tube.

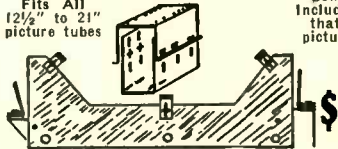

\$6.97

TV CRYSTAL-CLEAR LUCITE MASKS
Framed in Rich Gold Leaf Finish

Tube Size	Overall Dimensions	
17" — Rect. 13 1/2" x 17"		\$ 5.97
21" — Rect. 15 3/4" x 20 7/8"		8.84
24" — Round 20 1/2" x 26 1/4"		14.65
27" — Rect. 21 1/2" x 27"		15.48

(Including Set of Rosettes)

72 OHMS COAXIAL CABLE

100' — hank.....	\$ 4.64
500' — spool.....	21.99
1000' — two 500' spools ..	39.86



Modernize a #630 or any TV Set with a **STANDARD CASCODE TUNER**
For better all around performance

Complete with tubes, and Brooks CASCODE MANUAL with step-by-step instructions and all extra parts needed. **\$22.49**

TV PLASTIC OPEN MASKS
Used in conjunction with safety glass

17" — Rect. 14 1/8" x 17 1/2"	\$1.87
21" — Rect. 18" x 22 5/8"	3.36
24" — Round 20" x 27"	6.74
27" — Rect. 21 1/2" x 27"	7.23

MISCELLANEOUS ITEMS

TV POWER TRANSFORMER, 250 ma.....	\$3.97
RCA FLYBACK TRANSFORMER, doubler	1.24
VERTICAL OUTPUT TRANS., 10 to 1 ratio	.99
HV CONDENSER (cartwheel) 10kv-500v	.16
SELENIUM RECTIFIER, 100 ma.....	.88
SELENIUM RECTIFIER, 175ma.....	.76
AUDIO OUTPUT TRANSFORMER, 8mfd-450v	.24
AUDIO OUTPUT TRANSFORMER, (50L6)	.29
AUDIO OUTPUT TRANSFORMER, universal	.78
I.F. TRANSFORMER COIL, 456kc.....	.34
I.F. TRANSFORMER COIL, 10.7mc.....	.39
5" PM SPEAKER, alnico 5.....	1.14
AC LINE CORD, with molded plug.....	.12
QUARTER AMP. FUSE.....	.02
100—ASSORTED RADIO CONDENSERS.....	3.69
1000—ASST. TUBE CARTONS, all sizes.....	9.99

THIS REGENCY U.H.F. CONVERTER
Model #RC-600
Solves all U.H.F. Problems!

Regency spent a quarter-million dollars in the research and development of this U.H.F. CONVERTER

- Your assurance of U.H.F. performance at its best.
- Operates on ALL TV Receivers
- Gets ALL U.H.F. Stations
- Just plug in—No installation work

Underwriters' Approved
\$49.95 list price
Your price complete...only \$24.97

BROOKS RADIO & TV CORP., 84 Vesey St., Dept. A, New York 7, N.Y. TELEPHONE COrtland 7-2359

TECH-MASTER

High Fidelity Amplifier and Preamplifier KITS

- Tech-Master audio amplifier kits are made with the same "custom-quality" attention that has made Tech-Master the first name in TV chassis. They are built to a standard, not to the price. There have been no compromises . . . every component is the finest obtainable . . . workmanship is meticulous.

UL* WILLIAMSON TYPE AMPLIFIER KIT:

(with power supply.) Famous Williamson circuit with modifications for increased, undistorted power output. Uses specially wound quality output transformer.

Model TM-15A, DELUXE AMPLIFIER KIT: Factory assembled, all sockets, terminal strips and connectors riveted on chassis, ready to wire. . . . **Net Price . . . \$49.95**

*Ultra linear operation through use of screen-tapped primary output transformer

4 CHANNEL PREAMPLIFIER-EQUALIZER KIT:

Provides complete equalization for virtually all recording characteristics now employed. Extra flexibility provided by independent bass and treble boost and attenuation controls.

Model TM-15P, DELUXE PREAMPLIFIER KIT: Factory assembled, all sockets, terminal strips and connectors riveted on chassis, ready to wire. . . . **Net Price . . . \$19.95**

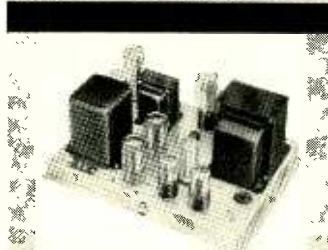

AT ALL LEADING RADIO PARTS DISTRIBUTORS



TECH-MASTER CORPORATION
75 FRONT STREET, BROOKLYN 1, NEW YORK

TECH-MASTER, MAKERS OF CUSTOM-BUILT TV CHASSIS,
QUALITY TV KITS & HIGH FIDELITY AUDIO EQUIPMENT.

Literature
Upon Request

TELEVISION SERVICE LIBRARY

HERE IS LATE INFORMATION IN A HANDY FORM FOR RADIO AND TELEVISION REPAIRMEN, SERVICEMEN AND STUDENTS



2 VOLS. \$6 COMPLETE \$1 A MONTH PAY ONLY 1 MO.

AUVELS T.V. RADIO SERVICE LIBRARY—Highly Endorsed—1001 Facts—Over 1552 Pages—625 Illustrations, Diagrams of Parts. Presents Important Subjects of Modern Radio, Television, Industrial Electronics, F.M., Public Address Systems, Auto, Marine & Aircraft Radio, Phonograph Pick-Ups, etc.

IT PAYS TO KNOW!

The Basic Principles—Construction—Installation—Operation—Repairs—Trouble Shooting. Shows How to get Sharp, Clear T.V. Pictures. Install Aerials—How to Test. Explains Color Systems, Methods of Conversion, Terms, etc. Includes Ultra High Frequency (U.H.F.)—Valuable for Quick Ready Reference & Home Study. Tells How to Solve T.V. & Radio Troubles—Answers Your Questions.

Get this Information for Yourself.
7 DAY TEST—ASK TO SEE IT!

MAIL ORDER

AUDEL, Publishers, 49 W. 23 St., N.Y. 10, N.Y.
Mail AUDELS T.V. RADIO SERVICE LIBRARY 2 Vols. \$6 on 7 days free trial, 100¢ M. I. will remit \$1 in 7 days and \$1 monthly until \$6 is paid. Otherwise I will return them.

Name _____
Address _____
Occupation _____
Employed by _____ RE

STAN-BURN E.P.A.-R.K.E.

CATHODE RAY TUBE SPECIALS

ONE YEAR GUARANTEE

	G.E.	STAN-BURN	
★ 10BP4A	\$14.95	10BP4	\$10.20
★ 12KP4A	24.45	12LP4A	11.90
★ 12LP4A	18.75	12QP4	13.95
★ 12QP4/B1014	21.00	12PP4	11.90
★ 12UP4B	28.75	12UP4A	14.50
★ 14CP4	24.50	14CP4	15.60
★ 15DP4/B1014	21.00	15BP4	17.50
★ 16KP4	23.75	16KP4	17.50
★ 16PP4	30.90	16PP4 or A	17.50
★ 16DP4 (N.U.)	25.25	16BP4 of A	17.50
★ 16CP4 or B	31.25	16FP4	17.50
★ 18KP4/16RP4	24.20	16WP4	17.50
★ 18KP4 (Aluminum)	28.35	16AP4	17.50
★ 16JP4A (N.U.)	25.25	16AP4A	23.00
★ 16LP4A	30.00	16EP4	19.00
★ 16WP4A	26.50	16EP4A	23.00
★ 16GP4B	31.25	17BP4 or A	21.00
★ 17BP4A	24.25	17BP4	18.50
★ 17CP4B	30.30	17CP4A	21.60
★ 17CP4A	23.90	17GP4B	22.60
★ 17CP4B (Aluminum)	29.00	19FP4	23.00
★ 19AP4A	41.50	19AP4	23.90
★ 20CP4	30.00	19AP4A	24.90
★ 20LP4	37.50	20CP4	23.95
★ 21AP4	42.00	21EP4	25.50
★ 21EP4A	31.80	21AP4	26.50
★ 21EP4A	36.35	24AP4	26.50
★ 24AP4	78.50		49.00

QUANTITY CRT USERS

We will give you DUD allowances if you ship them to us Prepaid, 10 CRT's minimum shipment. WRITE FOR DETAILS.

AUTHORIZED DISTRIBUTORS for: General Electric, Kenrad, Tung-Sol, National Union, De Wald, Regal, Automatic and General Motors.

AUTOMATIC CUSTOM-BUILT RADIOS for Plymouth, Ford, Chevrolet and many others, always in stock. We carry a complete stock of HI-FIDELITY and SOUND EQUIPMENT. Send us your requests. We also carry a complete line of popular makes of Radio tubes at 50/10% discount. Also many other special purpose and transmitting tubes, and all electronic parts and equipment at lowest prices. Send us a list of your requirements for prompt quotations. Terms: 20% with order. Balance COD. All prices F.O.B. NEW YORK Warehouse. Minimum order \$5.00. Write for our latest price list and HI-FI Catalog to Dept. RE-9.

STAN-BURN RADIO and ELECTRONICS CO.
1697 BROADWAY • NEW YORK 19, N.Y.

ELECTRONICS

design). A new low-voltage winding for a vibrator primary and battery-charging secondary was wound with No. 18 enameled wire in the space occupied by the original filament windings. This winding will require some cutting and trying, since it operates from a wave shape very different from the sine wave for which the transformer was designed. Start with a winding which will give 2 volts a.c. each side of the center-tap when 120 volts is applied to the primary. Be sure, in all testing, that the core is reassembled in the coils before power is applied! Check the operation with the battery and vibrator connected as shown in Fig. 4, measuring the voltage across the 120-volt winding with a 10,000-ohm resistor across it, and the .01- μ f buffer capacitors (C1 and C2) across the high-voltage section. Insulate the high-voltage leads during this test. Due to the squarish wave input they will probably put out a considerably higher no-load peak voltage. Add to or reduce the number of turns on the new winding until the output on the line winding is 120 volts. Note that the synchronous vibrator (Fig. 5) has been connected as a nonsynchronous one by paralleling the two sets of fixed contacts—this is done to provide better current-handling capacity since the load at the start of the capacitor-charging cycle is high (10 to 15 amps for the first few seconds). When the special winding is adjusted to give 120 volts on the line winding, the transformer is ready for use.

High-voltage rectifier units are available for use in the capacitor-charging circuit, or four 120-volt units of the type used in a.c.-d.c. receivers can be wired in series for each half-wave section as shown in Fig. 6. These units were assembled on old tube bases to simplify removal, and were substituted for the pair of 0Z4's which were used initially (Fig. 7). The 0Z4's (with sections paralleled) will work satisfactorily with the power-line supply, but the excessive peaks in the vibrator output cause early tube failures in all the 0Z4's I have tried.

Two safety features which seem worth special attention are included in the power-unit design. First, the knob on the main function switch, S1, is used as a lock on the hinged cover of the power unit (Fig. 8), by mounting the switch in the case of the unit and cutting a hole through the case cover, so oriented that the cover can be opened only when the switch is in the off position. The off position of the main switch not only opens the power connections but also connects discharging resistor R5 across the power capacitor bank. This prevents opening the power unit with the capacitors charged or charging. Second, power-adjusting switch S2 is a 3-position unit, and makes possible switching from high to low power, or vice-versa, without fireworks. Without buffer resistor R4 and supplementary discharging resistor

YOU be the Judge!

Let the Kay-Townes SUPER-KATY
prove its superiority over
ALL other TV antennas
on the market today!

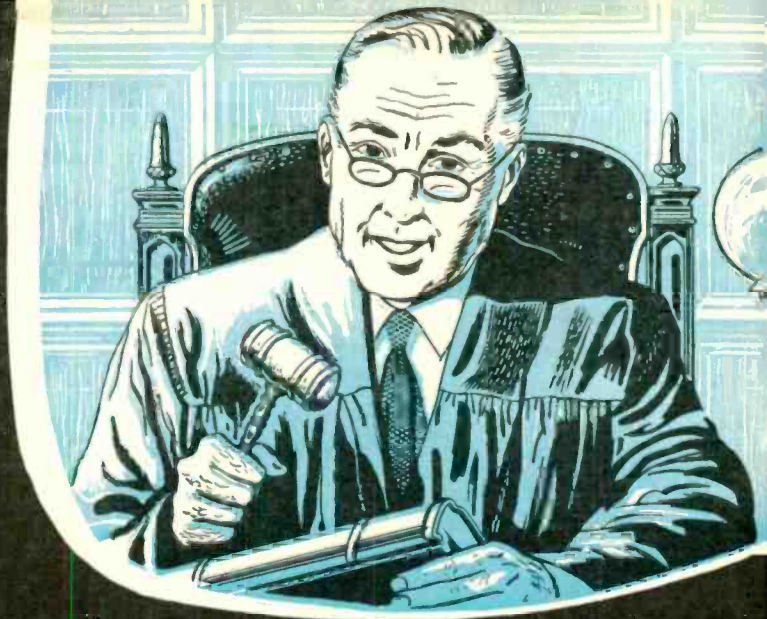

Here's why the famous
KAY-TOWNES

Super **KATY**

wins in every case!

- **FAR REACHING** Reception!
- **New MOLDED, RIBBED INSULATOR** for low water absorption!
- **New RIGID Construction** to withstand gale-force winds!
- **EASY Installation!**
- **LESS DEPTH** on mast!
- **Best by Color-Test!**
Super Katy has been proved the best antenna for fine color reception by actual field tests.

Every Super Katy installed
will bring **NEW SALES!**



Super **KATY-2**

**AMERICA'S MOST WANTED
TV ANTENNA**

"THE BEST SET IS ONLY AS GOOD AS ITS ANTENNA"

The long reach, long profit antenna

"Fringe area" dealer-servicemen in every part of the country are reporting outstanding sales and service stories... and, mounting TV consumer demand! The new, revolutionary Super "KATYS" have now convincingly proved every quality and performance claim attributed to them.

Kay-Townes' original SUPER KATY design... now amazingly improved... will out-perform any other competitive antenna on the market today, regardless of type or design principle!

Manufactured and Distributed in CANADA By
DELHI METAL PRODUCTS, LTD., DELHI, ONTARIO

**KAY-TOWNES
ANTENNA CO.**
ROME • GEORGIA

Originators of
the **BIG-JACK**
the world's most Copied TV Antenna

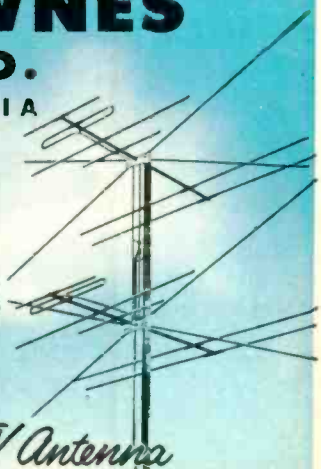

You Can Solve
Your Problems
in Handling

VHF and UHF

TV SIGNAL
AMPLIFICATION

CHANNEL
CONVERSION

TV SIGNAL
DISTRIBUTION

Easily...
Effectively...
Economically!

USE THIS HANDY COUPON

BLONDER-TONGUE LABORATORIES, INC.
Dept. VJ-13, Westfield, New Jersey

Please send me the following FREE Literature:

- The B-T 'Add-A-Unit'
Master TV System
- 'Add-A-Unit' Installation Manuq1
- TV Calculator
- UHF Converters

Name.....

Address.....

City.....Zone.....State.....

ELECTRONICS

R6 this switching would have to be done with the main switch in the off position to insure against throwing uncharged capacitor bank C3 across charged basic bank C4 with a resulting high current surge, or to switch C3 off without discharging it. This would leave it a hazard when the power unit is opened, or cause a heavy current surge when it is again switched into use.

Transformer T2 (Fig. 3) used to supply the striking pulse can be purchased, or a small, high-ratio iron-core transformer from the junk box can be used. The one I used is a surplus Ouncer microphone-to-grid unit. The high-voltage pulse is wired to the third conductor in the lamp cables (Fig. 9-a), and the corresponding terminals of

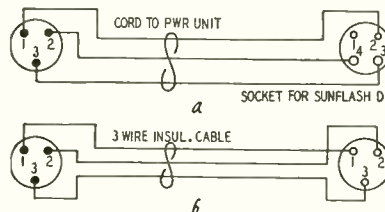

Fig. 9-a—Connection to slave lamp unit.
Fig. 9-b—Connection for extension cord.

the two receptacles are connected together, making either receptacle available for the master camera unit with the triggering pulse delivered to the other receptacle which can be used for the second slave lamp. An extension cord (Fig. 9-b) may be used in either lead, giving extra flexibility in the positioning of the power unit with respect to the lamps.

Parts for electronic photo-finish

Resistors: 2—100, 1—150, 2—18,000, 1—39,000, 1—330,000 ohms, 1/2 watt; 3—5,000, 3 watts; 1—30-ohm rheostat.

Capacitors: 2—.01 μ f, 800 volts; 1—0.1 μ f, 500 volts; 1—50 μ f, 1—100 μ f, 25 volts, electrolytic; 5—200 μ f, 500 volts, electrolytic.

Miscellaneous: 3—3-contact female connectors; 3—3-contact male connectors; 1—relay, normally open, s.p.s.t., 17-ohm coil (Advance type 003); 2—selenium rectifiers, half-wave, 75 ma, 500 volts a.c.; 1—rectifier, 6 volts a.c. half-wave, 2 amps; 1—4-pole, 4-position switch, rotary; 1—1-pole, 3-position switch, rotary; 1—1-pole, 3-position (on-off-momentary) switch; 1—YB-8-A 2-volt synchronous vibrator (ATR 900 or Mallory T4003 may be used with wiring changes); 1—rewound power transformer, 750-volt secondary, center-tapped; 1—Ouncer, mike-to-grid transformer, (photo-flash ignition coil, GE 86G41); 2—4-pin ceramic tube sockets (for Sunflash D tube); 1—battery, 2 volts, 20 ampere-hour storage (Willard BB 54); 1—neon glow lamp, NE 2 or NE 9; photo-flash tubes (Sunflash D).

Switch S3 provides a convenient disconnect for the shutter connection, and on its "momentary" side is a manual-triggering connection for open-shutter flash shots. If the switch is not easily available, a s.p.d.t. switch may be used with a push-button in the lead to ground for manual triggering.

Neither the electrical nor the mechanical construction of the electronic-flash system is critical; arrangement of parts and wiring are matters of personal preference and individual design. My power unit was built into a case made from aluminum roofing sheet and 1/8-inch Masonite.



Special Offer On This Complete RADIO ENGINEERING LIBRARY

The Famous Library that Brings High-powered Help on the Whole Field of Radio Engineering. Places Authoritative Facts, Standards, Data, Practice, and Theory At Your Fingertips.

Now offered at a special low price, the Radio Engineering Library brings you almost 4000 pages of tested methods, standards, data and accepted practice. This Library will help solve hundreds of problems for designers, researchers, engineers, and students in any field based on radio.

Written by leading radio engineers, these books cover circuit phenomena, networks, tube theory, vacuum tubes, amplification, measurements, etc.—give specialized treatment of all fields of practical design and application. They provide you with a complete and dependable encyclopedia of facts.

5 volumes, 3872 pages, 2770 illustrations

- Eastman's FUNDAMENTALS OF VACUUM TUBES, 3rd Edition
- Terman's RADIO ENGINEERING, 3rd Edition
- Everitt's COMMUNICATION ENGINEERING, 2nd Edition
- Hund's HIGH FREQUENCY MEASUREMENTS, 2nd Edition
- Henny's RADIO ENGINEERING HANDBOOK, 4th Edition

SEND NO MONEY

Special Low Price—Easy Terms

On this special offer you get this Library for \$38.00, instead of \$48.00. You save \$10 and may pay on easy terms. Mail coupon below to examine the Library FREE for 10 days. No obligation. These books are recognized as standard works; you are bound to need them. So take advantage of this special money-saving offer. Mail coupon at once!

McGraw-Hill Book Co., Dept. RE-9
327 West 41st St., New York 36, N. Y.

Send for 10 days' FREE trial, the RADIO ENGINEERING LIBRARY. If not satisfied I will return books. Otherwise I will send \$8.00 plus delivery charges then; and \$6 a month for 5 months. (Reg. price \$48.00, you save \$10.00.)

Name

Home Address.....

City & State.....

Employed by.....

We'll pay Delivery Charges if you enclose \$8.00 first payment WITH coupon. Same return privilege for full refund.

(Offer applies to U. S. only) RE-9

The New Brach Sky Chief ROTATOR

MODERN design combined with ruggedness, serviceability, the exclusive new "FLEXIBLE" WORM GEAR and a built-in thrust bearing are the main features of the new Brach SKY CHIEF Rotator. Below is the new control unit shown in *actual size*. It has a fine furniture finish and is styled to blend with the decor of all living rooms. Truly the Brach Rotator control unit is Designed for Modern Living. After two years of research and experimentation in the Brach laboratories, we now

claim the following features for the Brach SKY CHIEF.

Designed for Modern Living

- Exclusive flexible worm gear assures operation in high winds, with ice loadings, and massive antenna arrays.
- Super-strength precision cut bull gear.
- Greatest starting and operating torque.
- Easily replaceable motor.
- No drift-dynamic stop control.
- Designed for all chimney and mast mounts.

Designed For Modern Living

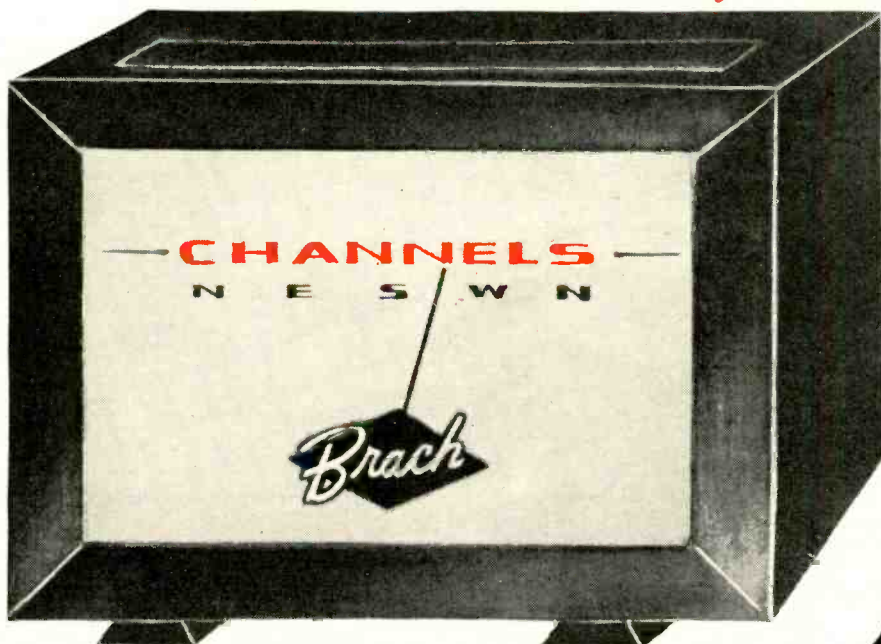

THIS IS THE ACTUAL SIZE OF THE CONTROL BOX

Model No. 54 M

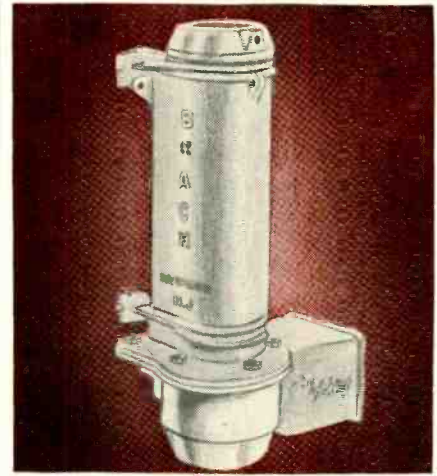

Weatherproof design - built in guy mounting adaptable for chimney or high mast installations

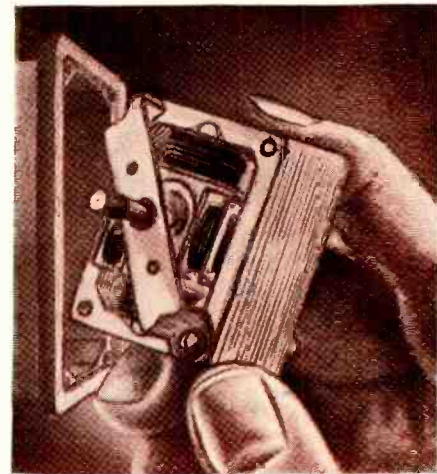

Motor easily replaceable—just plug-in.

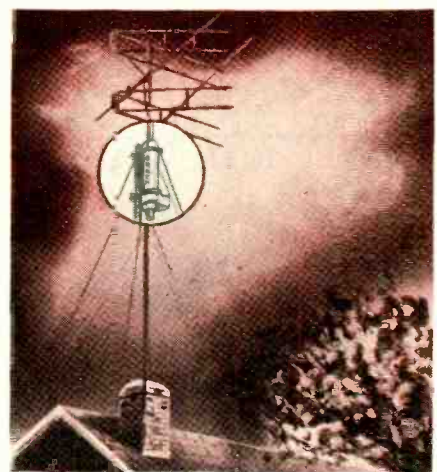

Super-strength construction assures safety against high winds, ice loading and massive antenna arrays.

BRACH MANUFACTURING CORP. • Div. of General Bronze • 200 CENTRAL AVE., NEWARK 3, N. J.

25% more power

... with the new

ELECTRO "D-612"

6/12 Volt DC Power Supply

at no extra cost



ONLY
\$39⁹⁵ NET
An assembled unit at a price comparable to kits.

2 Reasons why Electro "D-612" gives 25% more power and supplies 10 amperes at both 6 and 12 volts continuous.

- 1** Heavy duty control transformer offers better regulation and withstands overloads for long service.
- 2** Electro application of larger selenium rectifiers, combined with EPL patented conduction cooling increases rectifier power rating.

Other advantages of the "D-612" are rugged construction; continuously variable control and superior filtering (less than 5% ripple over rated ranges). Operates all 12 and 6 volt auto radios, plus relays, phone circuits, low voltage devices. For electroplating and battery charging.

Only Electro provides actual proof with performance charts.

Model "NF" DC Power Supply 0-28 volts, 15 amps. continuous for all low-voltage applications.

Model "S" Battery Eliminator converts battery radios to AC all-electric.

Send for free literature today!

ELECTRO PRODUCTS LABORATORIES

4501-Ra Ravenswood Ave., Chicago 40, Illinois

Canada: Atlas Radio Corp., Ltd., Toronto



ELECTRONICS

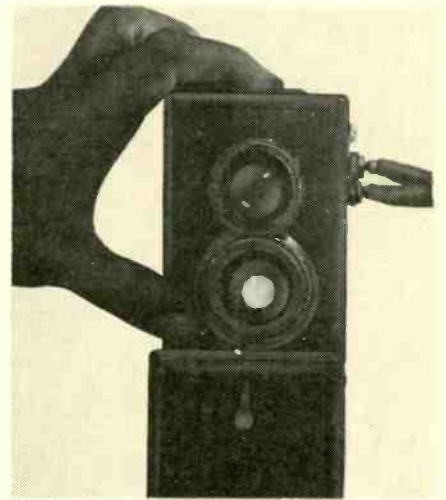

Fig. 10—Shutter at its largest opening.

APPROXIMATE GUIDE NUMBERS

Watt-second output	50	75	100	125	150
Daylight Color Film: Kodachrome, Ektachrome, Ansco Color	20	24	29	34	40
Verichrome, Plenachrome, Plus-X	80	95	115	135	160
Plus-X, Super XX, Supreme, Super-Pan Press	100	115	135	155	180

A slave lamp unit is often helpful in properly lighting a flash shot. A three-wire cord with a plug on one end, a socket and reflector on the other, and some clamping arrangement for holding the reflector—and the job is done. The system works with or without the slave lamp—it can be added at any time.

After the system is completely assembled, synchronization can be adjusted by opening the back of the camera (Fig. 10) and looking through the lens while the shutter is operated at its largest opening (smallest f number). The flash will be fast enough to stop the shutter action so that the lens opening, if the flash is not properly synchronized, will have an irregular and smaller opening than its full-open image. Adjust the 30-ohm rheostat (Fig. 3) to a position where the flash shows a full opening of the shutter to complete synchronization, and the system is ready to operate. The table will serve as a guide to exposure with this system, but reflectors, backgrounds, film processing, and other factors introduce variations that make a firm specification impracticable—a roll or two of each type of film you plan to use, shot at a variety of subjects will permit you to establish the right guide numbers for your own films and the processing you prefer.

The experience gained in this exploratory work will repay itself many times when it saves you from just missing some prized shot for want of the proper guide number.

END

Check THE NEW
**HEATHKIT
SCOPE**
FOR
\$29⁵⁰
ON PAGE
69

Floritone EXTENSION SPEAKER "CONTROL AT YOUR FINGERTIPS"

The extra "personal" speaker for your TV—a "must" for the "hard of hearing" and the utmost in luxurious listening pleasure for every TV or radio owner. 4 in 1 switch controls either speaker—both speakers—or shuts off sound. Easily installed and lists for only \$14.95.

Dealers and distributors, write for liberal discount information.

SOOTIN'S, INC.

321 NW 3rd Ave., Miami 36, Fla.



SAMPLE
\$10-00

(Dept. R.E.)

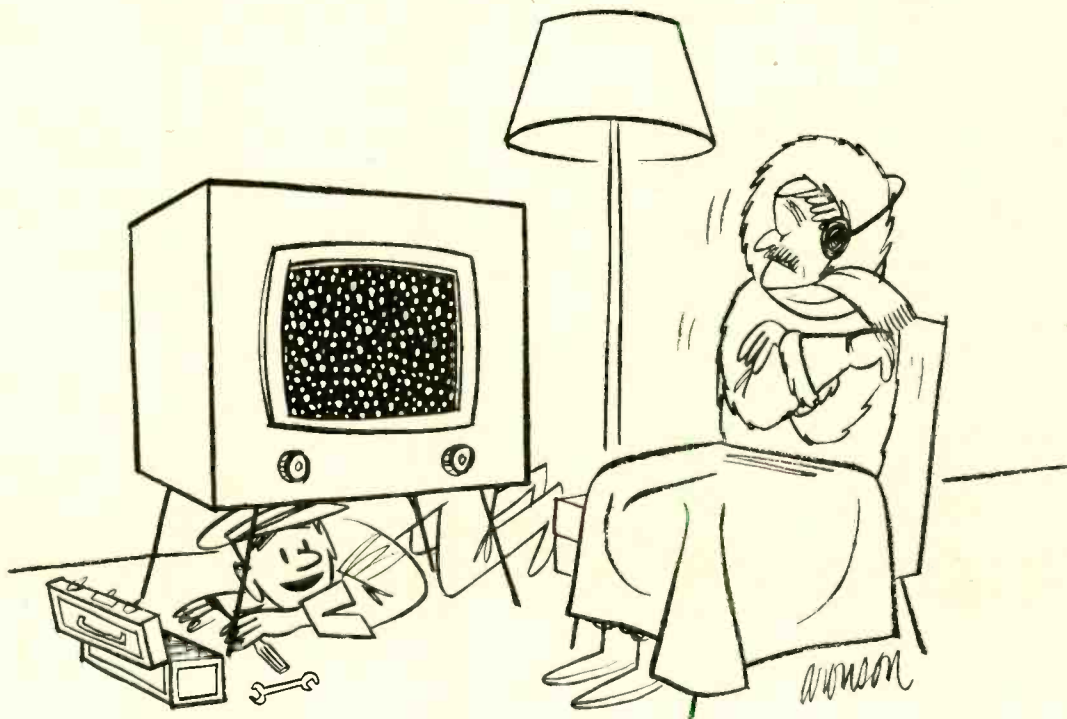

YOU DON'T NEED A FUR
COAT; JUST SPRAGUE
CAPACITORS!

Don't Be Vague... Insist on SPRAGUE

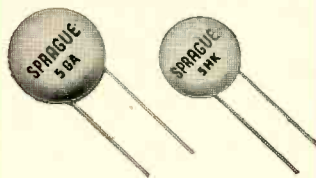

Insist on Sprague CERAMICS

Tiny, tough, dependable . . . in every application . . . whether discs, plates, buttons, or door knobs. And there's a Sprague ceramic capacitor to meet every service need. You give your customers dependable service, guard yourself against costly call-backs, when you use only Sprague Ceramic capacitors.



Insist on Sprague TWIST-LOK* 'LYTICS

Sprague TVL's fill the top performance bill in the toughest TV circuits. High temperatures, surge voltages, ripple currents won't faze them. Like all Sprague capacitors, Twist-Lok 'Lytics are your first line of defense against expensive call-backs.

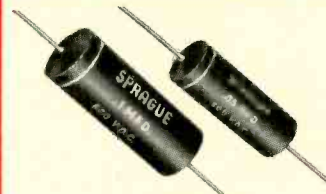

Insist on Sprague BLACK BEAUTY® TELECAPS®

The most imitated capacitor Sprague ever introduced. But you get Sprague *performance* only when you insist on Sprague Telecaps. Hundreds of millions are in use today as first choice of quality conscientious manufacturers and servicemen. It's the *premium* molded tubular at no extra cost.

Accept no substitutes. There is a Sprague Distributor in every sales area in the United States. Write for the name of your nearest source of supply today.

☆ Trademark

SPRAGUE

Get your copy of Sprague's latest radio and TV service catalog C-609. Write Sprague Products Company*, 81 Marshall St., North Adams, Mass.

*Distributors' Division of Sprague Electric Company

**WORLD'S LARGEST
CAPACITOR MANUFACTURER**

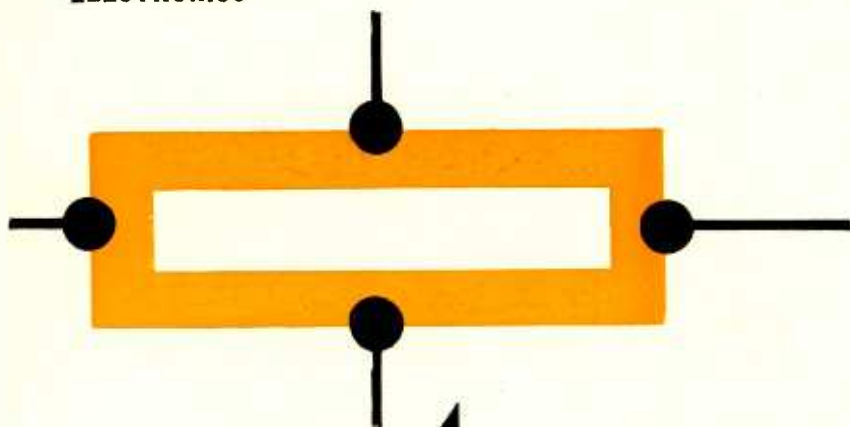

4-TERMINAL TRANSISTORS

by NATHANIEL RHITA

Adding an element widens transistor applications and possibilities

THE transistor is basically a 3-element device like a vacuum tube. It needs emitting, controlling, and collecting elements. Again like a tube, an amplifying crystal can often show improved results if a fourth element is added. Several types of 4-terminal transistors have been developed and tests show that remarkable results may be expected from them. Gain, saturation current, frequency range, and internal impedance are among the characteristics that can be improved by a fourth element or electrode.

Fig. 1-a shows a 4-zone semiconductor invented by Jewell J. Ebers of Whip-

pany, N. J. His patent (No. 2,655,610) has been assigned to Bell Telephone Laboratories. The zones are identified by P or N to indicate positive or negative type conductivity. The semiconductor can be prepared from a single crystal. It may have a cross-section area .03 inch on each side, with the outer zones .05 inch thick, and the inner ones .002 inch. Metal is plated at the ends of P1 and N2 for connecting leads.

Fig. 1-a shows typical voltages and a suitable hookup for the new transistor. P1, N1, and N2 function as emitter, base and collector, respectively. P2 is tied through R2 to the output circuit. This extra zone is a control element under the influence of R2. Emitter bias is varied by R1.

Fig. 1-b shows some of the remarkable results provided by this transistor. The graphs show how alpha (current gain factor) varies as R2 and the emitter current are changed. When R2 is zero, we have the case of an ordinary p-n-p transistor since N2 is shorted out. Therefore we find the usual constant alpha of almost unity. When R2 has a low resistance, for example several hundred ohms, there is a steep rise in alpha with emitter bias. In other words, R1 is a very effective gain control for this transistor. With a high R2 we find amazingly high alpha. With 10,000 ohms, for example, alpha is actually higher than 50. It remains nearly constant as emitter current varies.

The 4-zone transistor may also be connected as in Fig. 1-c. This requires a single battery supply and only two resistors. Due to interaction between zones, this circuit is excellent for triggering or switching work. Ordinarily we need a point-contact transistor for these purposes. The new 4-zone transistor, although a junction type, is just as effective. Thus we can take advantage of the junction features: high efficiency, low cost, and ruggedness.

The graph tells the story. If I is increased from zero, E rises sharply. This indicates a region of high positive resistance. After the peak value is

reached, further bias causes E to drop. This, of course, signifies negative resistance and instability, just what we need for a trigger. After point E., another positive resistance region appears. If I is increased past I_p, the transistor is flipped from a low current (open switch) condition to one of high current (closed switch). It is triggered back to its original state by any pulse that lowers I below its critical value.

In Fig. 1-c, I is controlled by either or both resistors.

Fig. 2-a shows a different type of transistor. There are only 3 elements here as in a conventional n-p-n junction type, but the base has two separate terminals. A voltage is applied between these two points, and the performance is improved remarkably. The current that flows between the two points in the base can reduce the resistance of this zone—down to zero if desired. In turn this extends the frequency range and increases transistor gain.

The simplest application of this new transistor is as a modulator. In this case we take advantage of the two inputs: one to the emitter, the other to the auxiliary base terminal. It is important to remember, however, the phase difference between them. In Fig. 2-a a more negative bias will increase output current. A greater bias at point A will decrease it.

Fig. 2-a is a modulator circuit. A carrier is fed to the emitter element. The d.c. bias flows through R1. The audio voltage modulates the carrier. Point A is biased by the same emitter battery but through a separate resistor (R2). These resistors permit individual adjustment of bias to the two control elements, and also isolate one from the other. The bias at A has the same polarity as that of the emitter. Modulated output flows through a transformer to a load (L).

Fig. 2-b shows the transistor as a frequency converter. T1 feeds energy back from the collector to the auxiliary terminal at the base. Polarity of the windings must be observed, so that

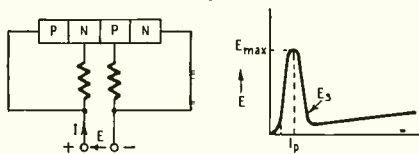
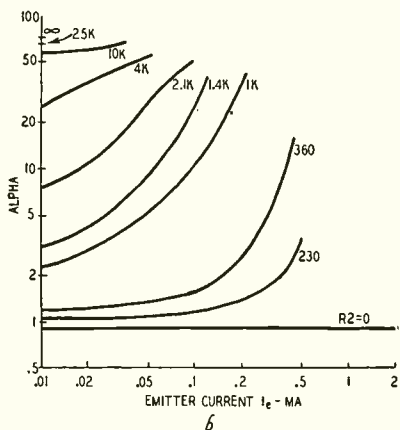
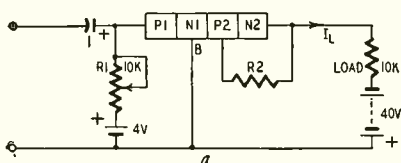
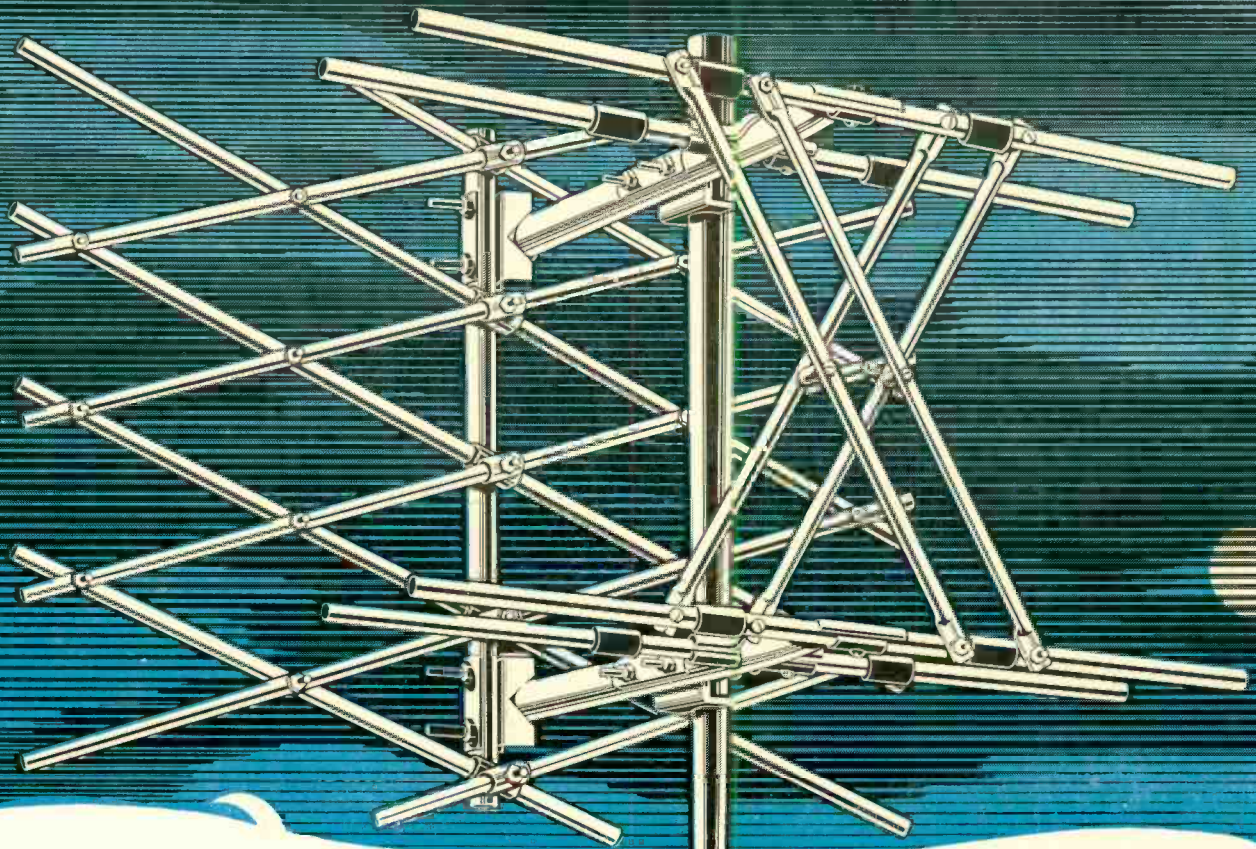

Fig. 1-a—The 4-zone semiconductor.
Fig. 1-b—Alpha-emitter bias curves.
Fig. 1-c—Circuit variation of Fig. 1-a.



Here's the ideal "all-channel" antenna
for fringe and far fringe reception

THE NEW RADELCO

DRAGNET*

MODEL DN2 FOR VHF • UHF

*with the Sensational
Diamond-Back Reflector*

- ★ Completely rejects interference from both back and sides.
- ★ Eliminates co-channel interference.
- ★ Front to back ratio far surpasses any other antenna on the market.
- ★ Superior all-channel gain.
- ★ Completely pre-assembled.

\$34⁹⁵
LIST

*Trade Mark
Registered
Pat. Pending

**The Dragnet
Has Been
Thoroughly
Field Tested**

After several years of development and field testing in all sections of the country, Radelco now gives you an antenna that definitely solves the reception problem in areas where reception has been found most difficult.

RADELCO MANUFACTURING CO.
CLEVELAND 25, OHIO



Dragnets are now being shipped to distributors throughout the nation. Place your order now with your favorite parts jobber.

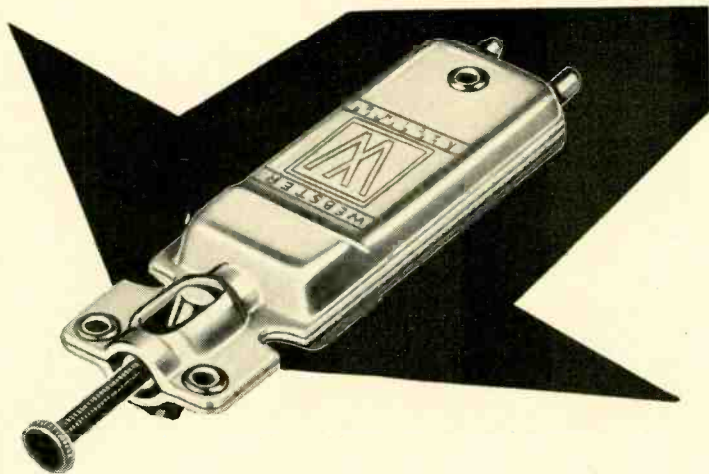

Announcing
another great new

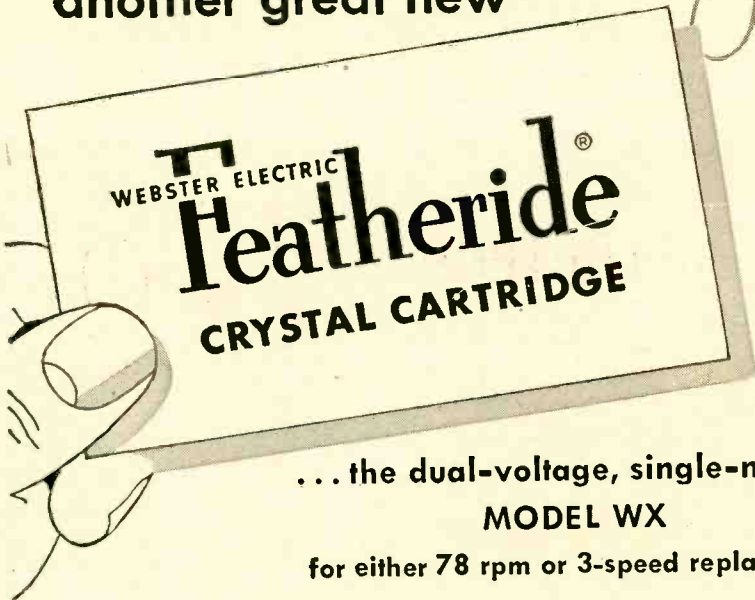

... the dual-voltage, single-needle
MODEL WX
for either 78 rpm or 3-speed replacement

DATA ON THE MODEL WX

- Type • Single-needle, dual-voltage crystal cartridge for 3-speed or 78 rpm use
- Output • See main text (right)
- Tracking Pressure • 14 gr. at 33½, 45 or 78 rpm
- Cutoff Frequency • 5,000 C.P.S.
- Net Weight • 7.25 gr.

Write for full information on the profit-building MODEL WX today.

WEBSTER ELECTRIC
RACINE WISCONSIN



"Where Quality is a Responsibility and Fair Dealing an Obligation"
WEBSTER ELECTRIC COMPANY, RACINE, WISCONSIN • EST. 1909

ELECTRONICS

load gain is even better. At last scientists seem to have the answer to an efficient junction transistor that will amplify and oscillate at high frequencies.

This transistor was invented by Robert L. Wallace, Jr. of Plainfield, N.J. His patent (No. 2,657,360) is also assigned to Bell Telephone Laboratories.

The internal impedance of the transistor elements are greatly influenced by the flow of base current, *I_b*. We show here only the effects on base resistance, which is probably as important as any. The resistance is drastically lowered and can even be made negative by a flow of less than 200 microamperes.

One or more types of multielement transistors are nearly ready for commercial distribution. The information contained here should help you to understand and make the best use of these new types, when they do make their appearance. END

**SWIFTEM ELECTRIC
CLINICAL THERMOMETER**

Here is the electrical thermometer described on page 6 of last month's RADIO-ELECTRONICS. The thermistor is the enlargement at the tip of the probe. It reacts so quickly to heat variation that a patient's temperature reading can be made in less than 5 seconds.

The meter portion of the instrument is calibrated directly in degrees, so that it can be read like a standard clinical thermometer. It is powered by a mercury-cell battery guaranteed for 750 hours of intermittent operation.

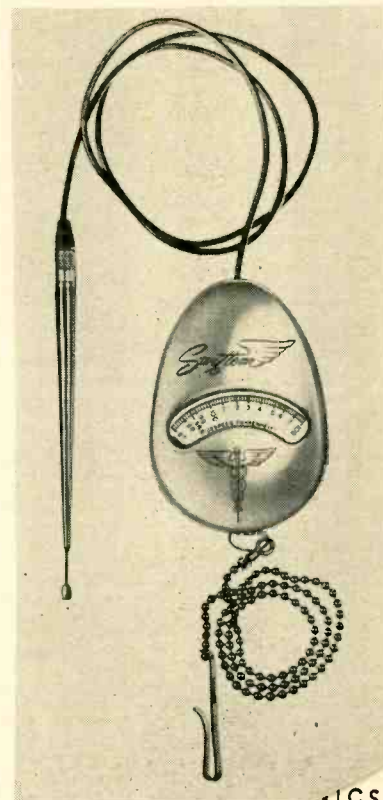
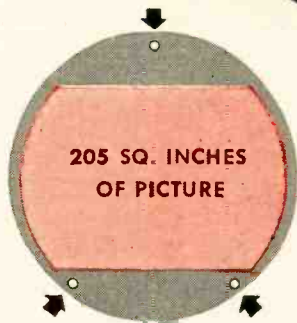
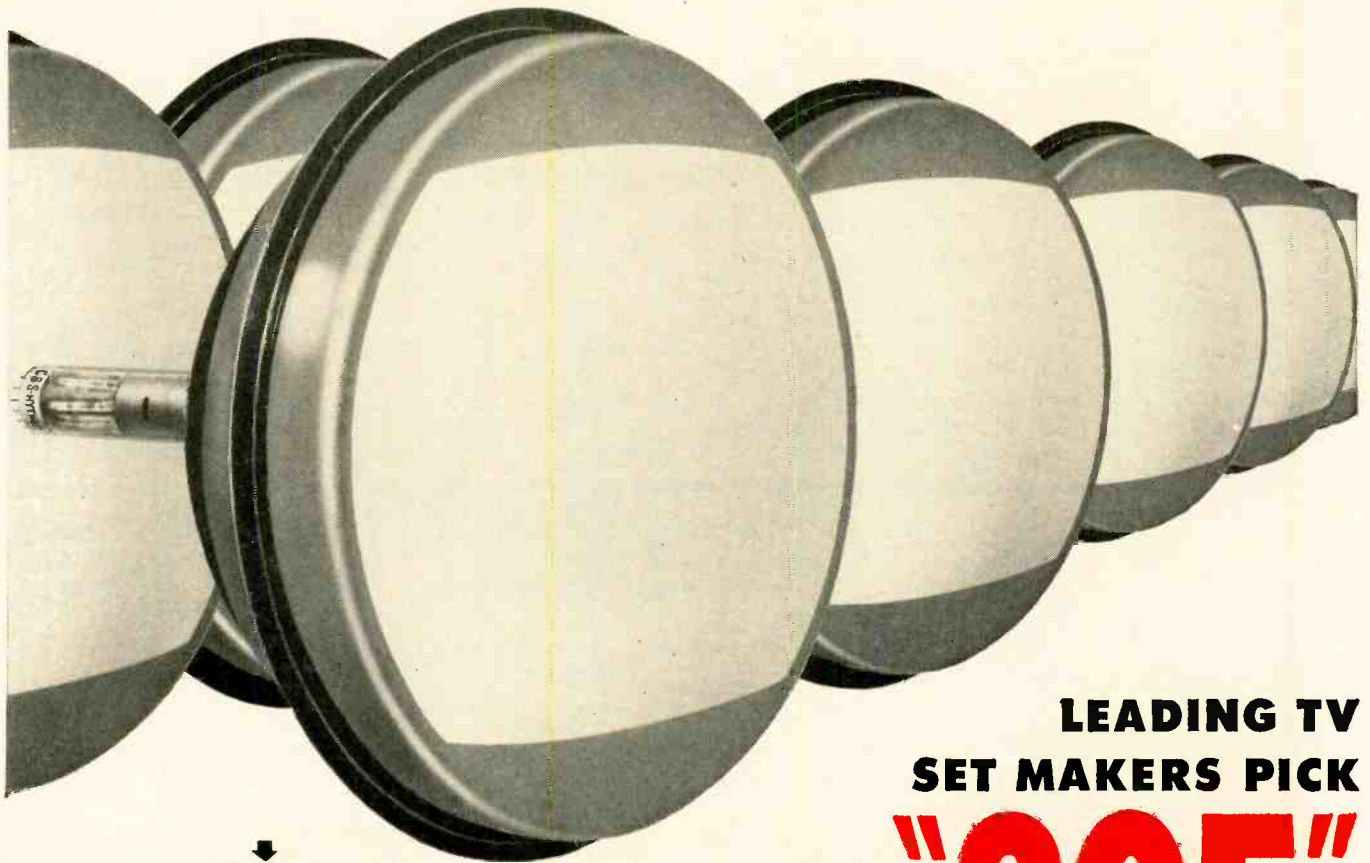

Photo Burlington



CBS-COLORTRON "205"

LEADING TV SET MAKERS PICK

LEADING BIG-SCREEN COLOR TUBE

- ... for **Biggest Picture**
- ... for **Superior Performance**
- ... for **Delivery NOW!**

HOW "205" ACHIEVES BIGGEST PICTURE

As its name implies, picture area of "205" is a big 205 square inches. The "205" achieves this maximum utilization of screen area: 1. By photographic printing of tricolor screen directly on inside of curved face. 2. By using a simple, light-weight shadow mask. 3. By positioning the three mask supports above and below the desired screen area . . . where the screen is masked off anyway by the set maker to obtain the desired 4 x 3 aspect ratio. This permits full lateral use of screen.



IT'S CBS-HYTRON FOR NEW COLOR RECEIVING TUBES TOO

TYPE	DESCRIPTION
CBS-Hytron 3A3	Half-wave, high-voltage rectifier
CBS-Hytron 6AM8	Diode, sharp-cutoff pentode
CBS-Hytron 6AN8	Medium-mu triode, sharp-cutoff pentode
CBS-Hytron 6BD4A	Sharp-cutoff beam triode, high-voltage regulator
CBS-Hytron 6BD6	Sharp-cutoff r-f pentode color demodulator
CBS-Hytron 6BJ7	Triple-diode d-c restorer

The CBS-Colortron "205" is *today* traveling in freight cars and trucks to the nation's leading TV set manufacturers. It was chosen by them, because of: The "205's" larger 205-square-inch screen. The "205's" over-all superior performance. The "205's" easier circuit adjustments. The "205's" absence of "pincushioning" and other distortion. And the "205's" availability in production quantities now!

BIG-SCREEN COLOR TV IS HERE . . . today . . . at CBS-Hytron. Original . . . simple . . . functional . . . advanced design of the "205" made this possible: 1. With its curved screen-mask construction. 2. With its maximum use of the screen area. 3. With its electromagnetically converged three-beam electron-gun assembly. And CBS-Hytron's huge, new Kalamazoo plant stands ready to step up the "205's" availability when needed. Yes, you can look to CBS-Hytron as the leader . . . and major producer of big-screen color picture tubes.

NEW . . . FREE "205" DATA

Keep abreast of big-screen color TV. Four-page sheet on CBS-Colortron "205," RETMA type 19VP22, contains complete data on: Construction . . . operation . . . application . . . installation . . . adjustment . . . electrical and mechanical characteristics. Write for Bulletin E-227 today!



CBS-HYTRON Main Office: Danvers, Massachusetts

A Division of Columbia Broadcasting System, Inc.

A member of the CBS family: CBS Radio • CBS Television • Columbia Records, Inc. • CBS Laboratories CBS-Columbia • CBS International • CBS-Hytron

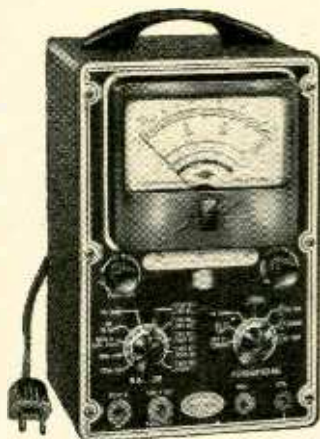

Measures 6 1/4" x 9 1/2" x 4 1/2"

Superior's new
Model 670-A

SUPER METER

A COMBINATION VOLT-OHM MILLIAMMETER PLUS
CAPACITY REACTANCE INDUCTANCE AND DECIBEL MEASUREMENTS

SPECIFICATIONS:

- D.C. VOLTS: 0 to 7.5/15/75/150/750/1,500/7,500 Volts
- A.C. VOLTS: 0 to 15/30/150/300/1,500/3,000 Volts
- OUTPUT VOLTS: 0 to 15/30/150/300/1,500/3,000 Volts
- D.C. CURRENT: 0 to 1.5/15/150 Ma. 0 to 1.5/15 Amperes
- RESISTANCE: 0 to 1,000/100,000 Ohms to 10 Megohms
- CAPACITY: .001 to 1 Mfd. 1 to 50 Mfd. (Quality test for electrolytics)
- REACTANCE: 50 to 2,500 Ohms 2,500 Ohms to 2.5 Megohms
- INDUCTANCE: .15 to 7 Henrys 7 to 7,000 Henrys
- DECIBELS: -6 to +18 +14 to +38 +34 to +58

ADDED FEATURE:

The Model 670-A includes a special **GOOD-BAD** scale for checking the quality of electrolytic condensers at a test potential of 150 Volts.

The Model 670-A comes housed, in a rugged crackle-finished steel cabinet complete with test leads and operating instructions.

\$2840
NET

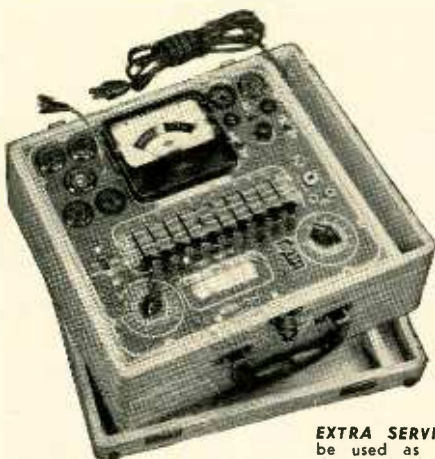

Superior's new
Model TV-11

TUBE TESTER

SPECIFICATIONS:

- ★ Tests all tubes including 4-, 5, 6, 7, Octal, Lock-In, Peanut, Bantam, Hearing Aid, Thyatron Miniatures, Sub-miniatures, Novals, Sub-minars, Proximity fuse types, etc.
- ★ Uses the new self-cleaning Lever Action Switches for individual element testing. Because all elements are numbered according to pin-number in the RMA base numbering system, the user can instantly identify which element is under test. Tubes having tapped filaments and tubes with filaments terminating in more than one pin are truly tested with the Model TV-11 as any of the pins may be placed in the neutral position when necessary.
- ★ The Model TV-11 does not use any combination type sockets. Instead individual sockets are used for each type of tube. Thus it is impossible

to damage a tube by inserting it in the wrong socket.

- ★ Free-moving built-in roll chart provides complete data for all tubes.
- ★ Newly designed Line Voltage Control compensates for variation of any Line Voltage between 105 Volts and 130 Volts.
- ★ **NOISE TEST:** Phono-jack on front panel for plugging in either phones or external amplifier will detect microphonic tubes or noise due to faulty elements and loose internal connections.

The model TV-11 operates on 105-130 Volt 60 Cycles A.C. Comes housed in a beautiful hand-rubbed oak cabinet complete with portable cover.

EXTRA SERVICE—The Model TV-11 may be used as an extremely sensitive Condenser Leakage Checker. A relaxation

type oscillator incorporated in this model will detect leakages even when the frequency is one per minute.

\$4750
NET



SUPERIOR'S NEW MODEL TV-40

C.R.T. TUBE TESTER

A complete picture tube tester
★ for little more than the price of a "make-shift" adapter!!

★ Tests all magnetically deflected tubes . . . in the set . . . out of the set . . . in the carton!!

The Model TV-40 is absolutely complete! Self-contained, including built-in power supply, it tests picture tubes in the only practical way to efficiently test such tubes: that is by the use of a separate instrument which is designed exclusively to test the ever increasing number of picture tubes!

EASY TO USE:

Simply insert line cord into any 110 volt A.C. outlet, then attach tester socket to tube base (*Ion Trap Need Not Be on Tube*). Throw switch up for quality test . . . read direct on Good-Bad scale. Throw switch down for all leakage tests.

SPECIFICATIONS:

- Tests ALL magnetically deflected picture tubes from 7 inch to 30 inch types.
- Tests for quality by the well established emission method. All readings on "Good-Bad" scale.
- Tests for inter-element shorts and leakages up to 5 megohms.
- Test for open elements.

Model TV-40 C.R.T. Tube Tester comes absolutely complete—nothing else to buy. Housed in round cornered, molded bakelite case. Only.....

\$1585
NET

SHIPPED ON APPROVAL
NO MONEY WITH ORDER — NO C.O.D.

Try any of the above instruments for 10 days before you buy. If completely satisfied then send down payment and pay balance as indicated on coupon. No Interest or Carrying Charges Added! If not completely satisfied return unit to us, no explanation necessary.

MOSS ELECTRONIC DISTRIBUTING CO., INC.
Dept. D-62, 3849 Tenth Ave., New York 34, N.Y.

Please send me the units checked. I agree to pay down payment within 10 days and to pay the monthly balance as shown. It is understood there will be no carrying, interest or any other charges, provided I send my monthly payments when due. It is further understood that should I fail to make payment when due, the full unpaid balance shall become immediately due and payable.

Model 670-A.....Total Price \$28.40
\$7.40 within 10 days. Balance \$3.50
monthly for 6 months.

Model TV-11.....Total Price \$47.50
\$11.50 within 10 days. Balance \$6.00
monthly for 6 months.

Model TV-40.....Total Price \$15.85
\$3.85 within 10 days. Balance \$4.00
monthly for 3 months.

Name

Address

City..... Zone..... State.....



Superior's New Model 770-A

The FIRST Pocket-Sized

VOLT-OHM MILLIAMMETER USING THE NEW "FULL-VIEW" METER

**71% MORE SCALE
AREA!!**

Yes, although our new FULL-VIEW D'Arsonval type meter occupies exactly the same space used by the older standard 2 1/2" Meters, it provides 71% more scale area. As a result, all calibrations are printed in large easy-to-read type and for the first time it is now possible to obtain measurements instead of approximations on a popular priced pocket-sized V.O.M.

THE MODEL 770-A COMES COMPLETE WITH SELF-CONTAINED BATTERIES, TEST LEADS AND ALL OPERATING INSTRUCTIONS. ONLY

Features

- ★ Compact — measures 3 1/8" x 5 7/8" x 2 1/4"
- ★ Uses "Full View" 2% accurate, 850 Microampere D'Arsonval type meter
- ★ Housed in round-cornered, molded case
- ★ Beautiful black etched panel. Depressed letters filled with permanent white, insures long-life even with constant use.

Specifications

6 A.C. VOLTAGE RANGES: 0-15/30/-150/300/1500/3000 Volts. 6 D.C. VOLTAGE RANGES: 0-7.5/15/75/150/750/1500 Volts. 2 RESISTANCE RANGES: 0-10,000 Ohms, 0-1 Megohm. 3 D.C. CURRENT RANGES: 0-15/150 Ma., 0-1.5 Amps. 3 DECIBEL RANGES: -6 db to +18 db, +14 db to +38 db, +34 db to +58 db.

\$15⁸⁵
NET

Superior's
New

TELEVISION BAR GENERATOR

THROWS AN ACTUAL BAR PATTERN ON ANY TV RECEIVER SCREEN



Two Simple Steps

1. Connect Bar Generator to Antenna Post of any TV Receiver.
2. Plug Line Cord into AC Outlet and Throw Switch.

Result: A stable never-shifting vertical or horizontal pattern projected on the screen of the TV receiver under test.

SPECIFICATIONS:

Power Supply: 105-125 Volt 60 Cycles
Power Consumption: 20 Watts
Channels: 2-5 on panel, 7-13 by harmonic
Horizontal lines: 4 to 12 (Variable)
Vertical lines: 12 (Fixed)
Vertical sweep output: 60 Cycles
Horizontal sweep output: 15,750 Cycles

FEATURES:

Provides linear pattern to adjust VERTICAL linearity, height, centering • Provides linear pattern to adjust HORIZONTAL drive, width, peaking, linearity, centering • Provides vertical sweep signal for adjusting and synchronizing vertical oscillator discharge and output tubes • Provides vertical signal to replace vertical oscillator to check vertical amplifier operation • Provides horizontal sweep signal for adjusting and synchronizing horizontal oscillator A.F.C. and output tubes • Provides horizontal sweep signal to check H.V. section of fly-back and pulse operating power supplies. Provides signal for testing video amplifiers • Can be used when no stations are on the air.

TV BAR GENERATOR COMES COMPLETE WITH SHIELDED LEADS AND DETAILED OPERATING INSTRUCTIONS. ONLY.....

\$39⁹⁵
NET



Superior's New Model 660-A AN AC OPERATED

SIGNAL GENERATOR

PROVIDES COMPLETE COVERAGE for AM-FM & TV Alignment

SPECIFICATIONS:

• Generates Radio Frequencies from 100 Kilocycles to 60 Megacycles on fundamentals and from 60 Megacycles to 220 Megacycles on powerful harmonics. • Accuracy and Stability are assured by the use of permeability trimmed Hi-Q coils. • R.F. available separately or modulated by the internal audio oscillator. — Built in 400 cycle sine wave audio oscillator used to modulate the R.F. signal also available separately for audio testing of receivers, amplifiers, hard of hearing aids, etc. • R.F. Oscillator Circuit: A high transconductance

heptode is used as an R.F. oscillator, mixer and amplifier. Modulation is effected by electron coupling in the mixer section thus isolating the oscillator from load changes and affording high stability. • A.F. Oscillator Circuit: A high transconductance heptode connected as a high- μ triode is used as an audio oscillator in a High-C Colpitts Circuit. The output (over 1 Volt) is nearly pure sine wave. • Attenuator: A 5 step ladder type of attenuator is used.

TUBES USED:

- 1-6BE6 as R.F. Oscillator, mixer and amplifier.
- 1-6BE6 as Audio Oscillator.
- 1-6H6 as Power Rectifier.

The Model 660-A comes complete with coaxial cable test lead and instructions.

\$42⁹⁵
NET

**SHIPPED ON APPROVAL
NO MONEY WITH ORDER — NO C.O.D.**

Try any of the above instruments for 10 days before you buy. If completely satisfied then send down payment and pay balance as indicated on coupon. No Interest or Carrying Charges Added! If not completely satisfied return unit to us, no explanation necessary.

MOSS ELECTRONIC DISTRIBUTING CO., INC.
Dept. DI-62, 3819 Tenth Ave., New York 34, N. Y.

Please send me the units checked. I agree to pay down payment within 10 days and to pay the monthly balance as shown. It is understood there will be no carrying, interest or any other charges, provided I send my monthly payments when due. It is further understood that should I fail to make payment when due, the full unpaid balance shall become immediately due and payable.

Model 660-A.....Total Price \$42.95
\$12.95 within 10 days. Balance \$5.00
monthly for 6 months.

Model 770-A.....Total Price \$15.85
\$3.85 within 10 days. Balance \$4.00
monthly for 3 months.

Television Bar Generator Total Price \$39.95
\$9.95 within 10 days. Balance \$5.00
monthly for 6 months.

Name

Address

City..... Zone..... State.....

New TUBE TESTER

Exclusive
HICKOK
Dynamic
Mutual Conductance

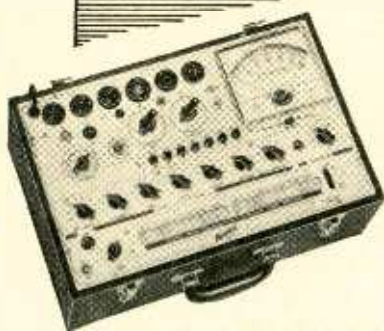

MODEL 600A

This fine tube tester is a lightweight portable. Popularly priced, the 600A is the Radio-TV serviceman and Industrial Technician's favorite. Backed by the HICKOK guarantee and built to the high HICKOK standard, this equipment will provide the necessary completeness and accuracy of tube testing required in the professional maintenance of radio-TV and industrial electronic equipment. HICKOK Dynamic Mutual Conductance circuits permit accurate tube evaluation. AC signal 2.5 volts: 0-3000, 6000, 15000 micromhos. Large, easy-to-read 5" HICKOK-built internal pivot meter. Tests all tubes including Color TV under simulated operating conditions. Includes the HICKOK bias potentiometer. Contains all the latest tube sockets and complete built-in tube reference chart.

This instrument is the lowest priced dependable quality tube tester available. Through increased accuracy and time saving completeness, the 600A will pay for itself in the shortest possible time.

Write today . . . for full details on the world's most complete line of quality vacuum tube testers.

THE HICKOK ELECTRICAL INSTRUMENT CO.
10531 Dupont Avenue • Cleveland 8, Ohio

NEW PATENTS

FREQUENCY-SHIFT MEASUREMENT

Patent No. 2,677,015

Arthur H. Hausman, Alexandria, Va.

(Assigned to the United States of America as represented by the Secretary of the Navy)

Certain types of radiotelegraph systems use the frequency-shift method. The transmitter output is constant, but its frequency shifts from one value (mark) to another (space). This invention measures the shift, that is—the difference between mark and space frequencies.

The diagram shows a Foster-Seeley discriminator followed by an amplifier, phase-inverter,

As the carrier shifts from space to mark (and vice versa) a.c. is generated. Frequency depends upon the rate of shift and may be as low as one cycle. Thus all coupling capacitors must be extra large to pass the low frequency. The amplitude of the a.c. depends upon the amount of shift, that is, the difference between space and mark frequencies.

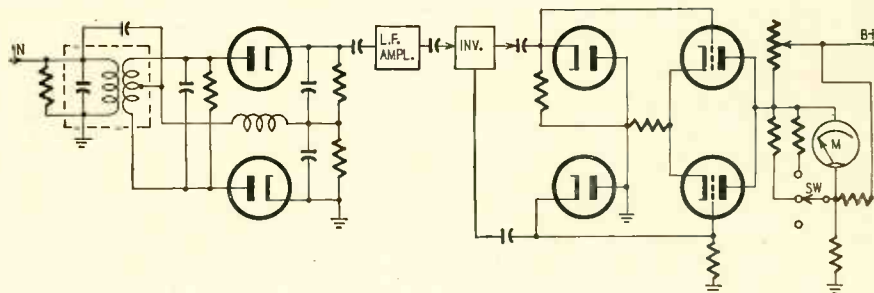

and a pair of limiters. The diodes are fed in push-pull, and their outputs are always positive. For example, in the upper diode electron flow can occur only from ground to cathode, so this element can never go negative. The output triodes are connected in push-push. Their grids are fed out of phase and their anodes are tied together. A push-push stage acts as a doubler, for no matter which triode conducts, anode current flows.

As in any FM receiver, the discriminator converts frequency changes into amplitude changes.

The a.c. voltage is delivered to the meter, calibrated in terms of frequency shift. Zero adjustment of the meter is controlled by the potentiometer, and the switch controls the sensitivity. Since a very low frequency might produce irregular meter readings, the doubler stage is included to increase frequency to a point where readings will be reliable.

The potentiometer controls the input to the upper diode. It should be adjusted so equal and opposite voltages are impressed across the diodes.

ARTIFICIAL REVERBERATION

Patent No. 2,674,660

James R. Ambrose, Indianapolis, Ind.

(Assigned to Radio Corp. of America)

Echoes and reverberations are among the special sound effects needed in dramatic shows and for commercial announcements. This invention, simpler than most previous ones of this type, reproduces multiple sounds from tape.

The tape passes over an erase head (Fig. 1) as in conventional machines. Two record heads are next in line. Each of these covers only a single channel, that is, half the tape width. The five reproduce heads cover the entire tape width so they are affected by both channels.

The desired sound from an input circuit is recorded by each record head at different points along the tape (Fig. 2). Thus as each reproduce head passes these points, the sounds become audible. The original sound is heard 10 different

times since there are five reproduce heads and two record heads.

Each reproduce head has its own preamplifier and attenuator. This makes it possible to adjust the volume controls so that each reverberation is weaker than the previous one. Furthermore, note that one record head is fed with the full input while the other receives a fraction of this voltage. Therefore the first five reverberations heard (from the upper channel) will sound louder than the next series, which are recorded on the lower channel.

Another feature is that the output of one or more reproduce heads may be fed back through an amplifier for re-recording. Thus, if desired, an echo can be sustained indefinitely.

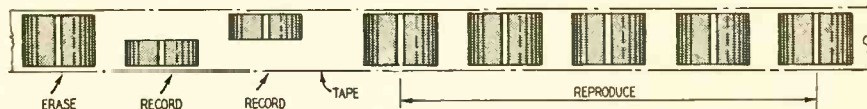

Fig. 1—Diagram showing arrangement of erase, record and reproduce heads. Record heads cover one track (channel) only; reproduce heads cover whole tape.

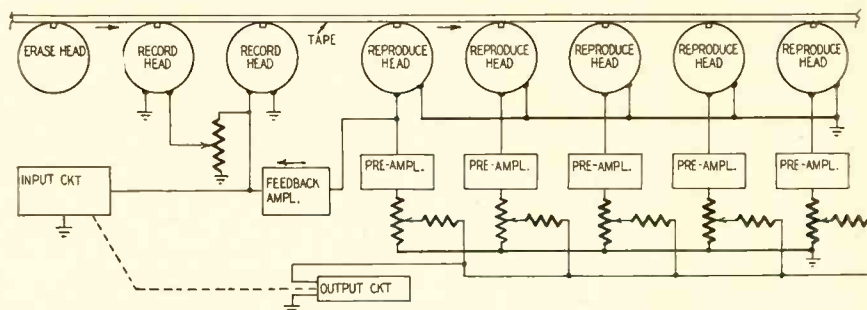

Fig. 2—Sound from input circuit is recorded at two different points. Separate preamplifier volume controls permit a gradual decay of sound.

New Flyweight Magnemite*



Electric-Motor Battery-Operated Portable Recorder

The ideal recorder for newspaper reporting, recording lectures, telephone monitoring, field reports traveling secretary, on-the-spot interviews, reference recording, customer interviews, salesmen reports and secret recordings.

Combines, for the first time, ease and efficiency of operation with maximum reduction of weight. Performs anywhere, producing professional results under adverse conditions. Fly-ball governor-controlled electric motor plus triple shielding assures constant speed and freedom from hash. Weather-tight, satin-finished, aluminum alloy case gives complete protection to recorder. 6 Models available in wide choice of speeds.

Check these unusual features:

- ★ Records for 4 full hours (Model 310-A)
- ★ Operates from self-contained dry cells
- ★ Immediate playback
- ★ Size; 5 1/2 x 9 x 12 inches
- ★ Weight; only 8 pounds

Write for complete technical literature and direct factory prices to Dept. RE

AMPLIFIER CORP. of AMERICA

396 Broadway, N. Y. 13, N. Y.

*T.M. Reg. U.S. Pat. Off

Resistors Galore!



THE GREATEST SPECIAL EVER OFFERED...

Values from 10 Ohm. to 10 Meg. Ohms. Wire wound and carbond. All plainly marked. Tolerance of 5%-10%-20% with wattage from 1/2-1-2-5-10 Watt.

300 RESISTORS, ASSORTED...

ALL BRAND NEW AND GUARANTEED PERFECT

ONLY **299*** POSTPAID U.S.A.

A CARTON OF 1000.....only \$8.95
*When Money Accompanies Order

ELMHURST RADIO & TV
4608 Sand Point Road
FORT WAYNE, INDIANA

NEW PATENTS

TWO-WAY AMPLIFIER

Patent No. 2,662,122

Robert M. Ryder, Summit, N.J.
(Assigned to Bell Telephone Laboratories, Inc.)

A tube can transmit and amplify in only one direction. If communication is to be carried on in both directions (forward and reverse) we must use at least two tubes or use a send-receive switching device. On the other hand, a transistor transmits and amplifies in both directions at the same time, if its gain is greater than 1. A point-contact transistor has this characteristic.

Either base or emitter may be used as the

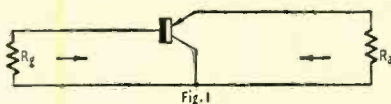

Fig. 1—Diagram shows collector as common element.

input element of a transistor. The collector is the common or grounded element. Fig. 1 shows a basic hookup. When signals are transmitted from left to right, R_c is the source and R_a the

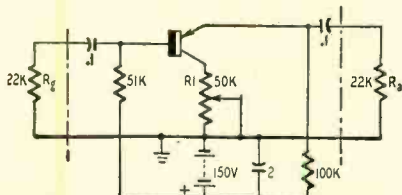

Fig. 2—Practical circuit—transistor is R-C coupled.

load. For reverse transmission, R_a is the source and R_c is the load.

Fig. 2 is a practical circuit. Although the transistor is R-C coupled to source and load, matching transformers may be used instead. A single battery supplies all input power. R_1 varies the current gain and determines the ratio of forward to reverse amplification. For equal transmission in both directions, it may be adjusted for a gain of 2.

RE-RECORDING DEVICE

Patent No. 2,675,430

Kenneth K. Clarke,
Chromepet, Madras, India.

Erasability is an important feature of magnetic recording. If any portion of a tape recording is found to contain an error, it is easy to erase that portion and substitute a corrected version. The problem is to fit the re-recording into its exact place, without overlap or delay. This invention controls the re-recording so that it starts and ends at precisely the correct spots. It operates automatically.

When S_1 is thrown to position a , divider R_1 , R_2 places a positive potential on the grid

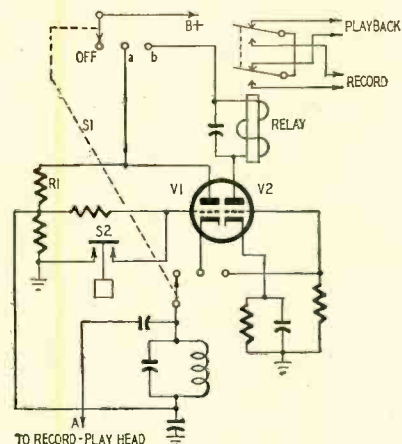

“SHALL I BUY A TURNTABLE OR A RECORD CHANGER?”



GET THE FACTS from one of America's leading manufacturers of professional recording and playback equipment.

Write today.

REK-O-KUT COMPANY, Dept. PJ-13
38-01 Queens Blvd., Long Island City 1, N. Y.

Please send me the facts on turntables and record changers.

Name.....

Address.....

City..... Zone..... State.....

My Dealer is.....

To Attire **YOUR HIGH FIDELITY SYSTEM** in Woodcraft Splendor...

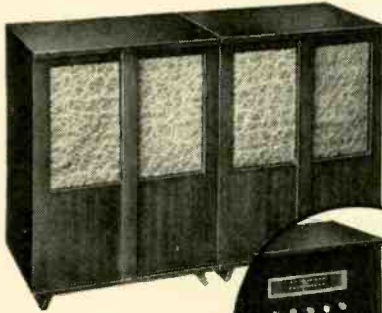

Equipment Cabinet has FOLD-AWAY DOOR (illustrated)



The Master-Tone Series of TWIN Separable Equipment & Speaker CABINETS

Model 100A, Modern, Speaker Cabinet, Mahogany, **\$90.00 Net.**

Model 100E, Modern, Equipment Cabinet, Mahogany, **\$139.50 Net. Pair, \$226.50 Net.**

Available in Blonde Mahogany.
Also in Provincial Design
(Fruitwood or Mahogany)

EQUIPMENT CABINET

- Universal mounting accommodates any electronic components
- Open design assures adequate ventilation
- Convection cool: asbestos heat deflector protects finish

SPEAKER CABINET

- Non-vibration T-brace assembly and acoustical padding prevent internal reflections
- Exclusive CONCENTRI-VENT construction (damped concentric vented reflex) assures smooth low frequency response down to 30 cps.

- Exquisite authentic furniture designs rendered with magnificent artistry
- Precision acoustic engineering
- Highest grade 3/4" select-grain wood stock throughout
- Hand-rubbed mirror finishes
- Compact: each Cabinet approximately 30" H x 24" W x 17" D.
- May be placed side by side or separated into any convenient arrangement.

Write for free Catalog RE 9

STANDARD WOOD PRODUCTS CORP., 47 West 63rd St., N. Y. 23, N. Y.
The Standard of Fine Woodcraft

NEW PATENTS

of V1 and this triode conducts. If S2 is closed momentarily, the grid is grounded and the triode is blocked. S2 is a dashpot-type switch that remains closed for only a short interval. Thus for a moment after depressing S2, V1 is cut off. This shocks LC into oscillation at its natural frequency, about 15 kc. The high frequency appears at terminal A which leads to the record-playback head, and a super-audible beep or marker is recorded on the magnetic tape.

If errors are discovered in a recording, the tape is played back and a marker is recorded before and after each error by operating S2 at the proper times.

To re-record the selection, it is played again into the recorder mike with the ganged switch in position *b*. In this position, V1 is out of the circuit and V2 is connected. The normal position of the relay armature is as shown, so the original recording is heard. When the first marker pulse is reached, the high frequency is impressed (through terminal A) at the grid of V2 and is amplified. It energizes the relay so that the armature is snapped to "record." At this instant the re-recording begins and replaces the original sound. When the next marker is reached, there is another pulse and the relay armature is snapped back to "playback," ending the re-recording. All this is done automatically and without need for attention of the recordist.

The V2 plate relay is any locking type whose armature alternates between its positions each time it is energized.

D.C. GAIN CONTROL

Patent No. 2,676,271

Edwin G. Baldwin, E. Orange, N.J.
(Assigned to Bell Telephone Labs., Inc.)

This circuit uses an *n* type point contact transistor. Control is governed by a d.c. voltage applied to the transistor. The signal may be a.f. or r.f.

The base circuit includes three crystal rec-

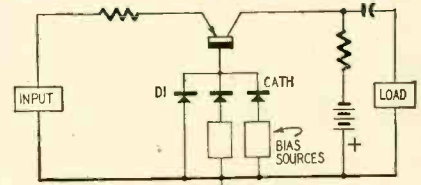

tifiers. Two of them are biased by d.c. potentials, normally negative. Thus D1 is the only conducting diode, and the positive charges can pass through it from ground to the base. Its low resistance generates a small amount of positive bias for the emitter.

If either d.c. bias voltage is reversed (that is, made positive) the corresponding diode begins to conduct. Then the positive voltage is applied directly to the base and the transistor gain is reduced. Using a pair of control potentials and diodes permits either one to control gain. Alternatively, one control potential may be larger than the other, providing for different gain levels through the transistor.

This circuit may be controlled by push-buttons, if desired. **END**

NEW STOCK OF FIRST QUALITY

TELTRON TUBES

GUARANTEED!... LOWEST PRICES EVER!

All tubes individually boxed... unconditionally guaranteed for one year!

GIFT OFFER!
One 6BG6G tube will be shipped FREE with any order accompanying this ad.

Type	Price	Type	Price	Type	Price	Type	Price	Type	Price	Type	Price	Type	Price	Type	Price
OZ4	.45	5U4G	.43	6AV6	.37	6BY5G	.60	6SN7	.60	12AV6	.42	25L6GT	.41	25W4GT	.43
1A7GT	.53	5V4G	.49	6AX4GT	.60	6BZ7	.95	6S07GT	.38	12A7V	.73	25Z5	.55	25Z6GT	.36
1B3GT	.82	5Y3GT	.30	6AX5GT	.60	6C4	.41	6T8	.71	12AX4GT	.60	35B5	.48	35W4	.33
1H5GT	.51	5Y4G	.40	6BA6	.56	6CB6	.51	6U8	.76	12AX7	.51	35Y4	.42	35Z5GT	.32
1L4	.51	6A8	.40	6BA7	.58	6CD5G	1.63	6V3	.80	12AZ7	.65	50A5	.49	50B5	.48
1L6	.51	6K7	.40	6BE6	.46	6CU6	.95	6V6GT	.48	12B4	.72	50C5	.48	50E5	.48
1LC6	.49	6Q7	.40	6BF5	.48	6F6	.42	6W4GT	.43	12BA6	.46	50L6GT	.50	TYPE 80	.40
1N5GT	.51	6AC7	.65	6BF6	.48	6F5GT	.44	6W6GT	.53	12BA7	.58	117Z3	.33	117L7GT	1.20
1S5	.43	6AG5	.52	6BG6G	1.18	6H6	.50	6X4	.37	12BE6	.46	117Z6GT	.85		
1T4	.51	6AH4GT	.65	6BH6	.51	6J6	.61	6X5GT	.38	12BY7	.65				
1U4	.51	6AJ5	.96	6BJ6	.51	6J5GT	.49	6X8	.80	12BZ7	.63				
1U5	.43	6AK5	.96	6BK5	.75	6K6GT	.39	7E8	.49	12K7	.45				
2A3	.35	6AL5	.43	6BK7	.78	6L6	.78	7N7	.49	12S47	.45				
2A7	.35	6A05	.48	6BL7GT	.78	6S4	.41	12AL5	.43	12S7	.45				
3Q4	.53	6AR5	.48	6BK7GT	.78	6S8GT	.65	12AT6	.37	12SL7GT	.60				
3Q5GT	.61	6AU5GT	.60	6BN6	.90	6SA7GT	.45	12A7V	.71	12S07	.38				
3S4	.48	6AV5GT	.60	6BQ6GT	.83	6SK7GT	.45	12A06	.43	19T8	.71				
3V4	.48	6A06	.43	6BQ7	.85	6SL7GT	.60	12A07	.58	25B06GT	.82				

FREE \$7.20 list value Bonus Box of three 6SN7 tubes and 25 assorted resistors with each order of \$25 or more

SAME DAY SERVICE

48 Hour Postal Delivery To West Coast

TERMS: Save all freight and postage charges. All orders accompanied by full remittance will be shipped POSTAGE PAID anywhere in the continental U.S.A. 25% deposit required on COD's. Minimum order \$10.00. Open accounts to rated firms only.

Send for Free complete tube listing and monthly specials! Get on our mailing list.

SPECIAL!—till Oct. 1

Type	Price	Type	Price
1R5	.44	6SA7	.41
1X2	.57	6SK7	.41
5Z3	.37	6SQ7	.35
6AB4	.35	12BH7	.55
6AF4	.89	12SN7GT	.48
6AT6	.34	19BG6G	1.09
6BC5	.41	35L6GT	.37

Watch for our monthly specials of key radio and TV types. Each month new key types will appear. Take advantage and order your requirements now.

TELTRON ELECTRIC COMPANY

428 Harrison Ave., Dept. RE9 Harrison, N. J. Phone HUmoldt 4-9848



"Sir, there's a man out here who claims he's invented a pocket TV transmitter."

OPPORTUNITY ADLETS

Rates—45¢ per word (including name, address and initials). Minimum ad 10 words. Cash must accompany all ads except those placed by accredited agencies. Discount, 10% for 12 consecutive issues. Misleading or objectionable ads not accepted. Copy for Nov. issue must reach us before Sept. 15, 1954.

Radio-Electronics

25 W. Broadway, New York 7, N. Y.

SPEAKER REPAIRS ON ALL MAKES. 8" & 12" HI-FI speakers for sale. Amprite Speaker Service, 70 Vesey St., New York 7, N. Y.

NEW OPENING OF BIGELOW ELECTRONICS. Pioneer Road, Beulah Michigan. All makes of test equipment repaired and kits constructed. Write for free information.

SPEAKER RECONING: Guaranteed workmanship. C&M Recone Co., 255 Tioga St., Trenton 9, N. J.

DIAGRAMS FOR REPAIRING RADIOS \$1.00. Record Changers \$1.50. Television \$2.00. Give Make, Model. Diagram Service, 672-RE, Hartford 1, Conn.

G.E. CARTRIDGES—\$3.95 VM Triomatic—\$23.50. Col-laro 3/532 Intermix-spindle-xtal—\$34.50. Tuners Amplifiers. Low Prices. Fidelity Unlimiteds, 63-03 39th Ave., Woodside, N. Y.

TUBES—TV, RADIO, TRANSMITTING, AND SPECIAL PURPOSE TYPES BOUGHT, SOLD AND EX-CHANGED. Send details to B. N. Gensler W2LN, 136 Liberty, N. Y. 6, N. Y.

ALL MAKES OF ELECTRICAL INSTRUMENTS AND TESTING equipment repaired. Write for free catalogue on new and used instruments at a savings. Hazleton In-strument Co., 128 Liberty Street, New York, N. Y.

BUILD YOUR OWN ELECTRONIC ORGAN, OR MINIA-TURE electronic brain. Jim Kirk, W6JKX, 1552 Church Street, San Francisco 14, California.

24 PAGES Plans "1-tube Receiver" (record 12,000 miles) with 6 issues "Radiobuilder". \$1.00. Laboratories, 328-B Fuller, Redwood City, California.

WANTED: AN/APR-4, other "APR.", "TS.", "IE.", ARC-1, ARC-3, ART-13, RC-348, etc. Microwave Equip-ment, Everything Surplus, Special tubes, Tec Manuals, Lab Quality Equipment, Meters, Fast Action, Fair Treat-ment. Top Dollar! Littell, Fairhills Box 26, Dayton 9, Ohio.

ALUMINUM TUBING. Angle and Channel. Plain and Perforated Sheet. Willard Radcliff, Fostoria, Ohio.

RECORDS—25-50% DISCOUNT on guaranteed factory fresh LP records; LP records 6¢ and up; pre-recorded tape. Send 20¢ for complete LP catalogue. SOUTHWEST RECORDS, 4710 Caroline, Houston 4, Texas.

TELEVISION RECEIVERS \$30 UP. W4API, 1420 South Randolph, Arlington 4, Virginia.

TV FM ANTENNAS. ALL TYPES INCLUDING UHF. Mounts, accessories. Lowest prices. Wholesale Supply Co., Lunenburg 2, Mass.



Free!

Get More Service Calls with

EICO DECALS

For Store Windows & Cars.

Write EICO

Brooklyn 11, N. Y. Dept. DC-9

ENJOY 3 COLOR TELEVISION FILTER SCREEN NOW

Changes dull eye-straining black and white pictures into beautiful color tones. Seconds to attach. No tools used. Helps eliminate glare and snow in fringe areas. Order direct. Send \$1 for screen size up to 16", \$1.25 size 17", \$1.50 size 20", \$2 size 21", \$2.50 size 24", \$3 size 27". (Also available are single solid color screens in blue, green, or amber.) Prices on solid color screens are 10% less. We pay postage except on C.O.D. orders. Satisfaction guaranteed. Inquiries from dealers also welcomed.

Zingo Products, Johnstown 13, New York

Compare AND YOU WILL CHOOSE . . .



New Specially Designed Horn-loaded High Fidelity Speaker System

The Largo is a complete wide range speaker system utilizing the new Permoflux 8V81 Super Royal Eight speaker and 32 KTR Super Tweeter in an acoustically advanced enclosure scientifically matched to the speaker characteristics. The enclosure is an entirely new and unique horn-loaded non resonant baffle with horn loading of the speaker back wave accomplished in the cabinet base. Every inch of the cabinet construction serves an acoustically useful purpose.

Baffle and speaker characteristics were matched octave by octave through laboratory tests to provide undistorted reproduction of all frequencies from 35 cycles to 16,000 cycles. Power handling capacity is 15 watts. A high frequency balance control is provided for matching individual room characteristics.

Its low contemporary styling is gracefully proportioned for decorative blending with the finest room decor. Precision constructed of selected 3/4" Mahogany and Korina veneers.

A Permoflux Exclusive: Special connection for headset extension cord for private listening and hard of hearing music lovers.

The Largo . . . Audiophile Net Price **\$99.75**

Enclosure styled by Contemporary American Furniture.

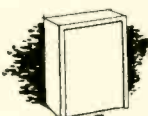

The Fortissimo—A 2-way multiple speaker system. Unique "New Dual Driving Point" Enclosure Design surpasses bass and mid-range performance of finest 12 and 15 inch systems. With 2 Super Royal 8 speakers and Super Tweeter. Cabinet beautifully styled in Mahogany or Korina Blonde veneers. Audiophile Net Price **\$218.00**



The Diminutive—A 2-way speaker system featuring full high fidelity performance with minimum cabinet size and low cost. With 2 Royal 6 speakers and Super Tweeter. In Mahogany or Blonde finish. Audiophile Net Price **\$49.50**

Visit your Hi-Fi dealer for a demonstration; also hear the New Super Royal Speaker (8, 12, and 15 inch sizes).

Send today for complete descriptive literature.

Permoflux
CORPORATION

4912 West Grand Avenue
Chicago 39, Illinois

West Coast Plant

4101 San Fernando Road

Glendale 4, California



(Patent Pending)

Fen-tone UHF CONVERTER

... breathtakingly beautiful
... unsurpassed performance

The new Fen-tone creation is indeed a masterpiece of engineering and styling. Small wonder it created a sensation in the 1954 Radio Parts Show. Use the Fen-tone UHF CONVERTER as a lamp, an illuminated aquarium, an illuminated plant vase. You don't "hide" this decorator's dream piece!

List Price \$29.95

Fen-tone VHF Booster of similar design, list price \$29.95

INTRODUCING . . .

Fen-tone "REX"
3-Speed Automatic Record Changer

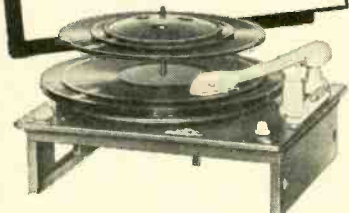

Created by craftsmen whose love for music inspired the finest phonograph instrument ever.

See Your Jobber

Literature on request.

FENTON Company

15 Moore Street, New York 4, N. Y.

OVER 97,000 TECHNICIANS HAVE LEARNED HOW TO GET THE MOST OUT OF BASIC TEST EQUIPMENT

for AM FM-TV

'Servicing by Signal Substitution'

A BEST SELLER FOR OVER 13 YEARS!
(NEW, UP-TO-DATE, 14th EDITION)

The Modern, Simplified, Dynamic Approach to all Receiver Adjustment & Alignment Problems

- ★ Nothing complicated to learn
- ★ No extra equipment to purchase
- ★ Universal . . . non-obsolete
- ★ Employs only Basic Test Instruments

Ask for "S.S.S." at your local Radio Parts jobber or remit 40¢ in small stamps or coin directly to factory.



ONLY 40¢
103 pages. Invaluable information that will help you redouble the value of your basic test equipment.

PRECISION APPARATUS COMPANY, INC.
92-27 HORACE HARDING BLVD., ELMHURST 4, N. Y.

Ring Up BIG PROFITS

in TV—Radio—High-Fidelity—Electronics

with

RADIO - ELECTRONICS

KNOW WHAT'S NEW . . . LATEST IDEAS . . . TESTED SERVICING TECHNIQUES

In the next few months **RADIO ELECTRONICS** will bring you:

- **TED TACKLES TOUGH TV TROUBLES**
Veteran technical writer Matt Mandl uses a lighter vein approach to difficult servicing problems.
- **TEST EQUIPMENT AND PROCEDURES IN UHF SERVICING**
Bob Middleton outlines the specific problems presented by UHF.
- **DESIGN AND CONSTRUCTION CONSIDERATIONS OF A WIDE-RANGE THREE-SPEAKER SYSTEM FOR SMALL SPACE HI-FI**
A description of the Diminutive speaker system.
- **DEMONSTRATION TRANSISTOR CIRCUITS**
Equipment and hookup for self study or classroom use.

. . . and many other practical features

FREE COLOR T.V. SERVICING GUIDE

. . . yours as a gift if you send your payment with your subscription!

O.K. Send me RADIO-ELECTRONICS

I enclose \$ Please bill me

PLEASE CHECK:

- One Year—12 issues—\$3.50
- Two Years—24 issues—\$6.00
- Three Years—36 issues—\$8.00

NAME (Please PRINT CLEARLY)

ADDRESS

CITY P.O. ZONE STATE

MAIL TO: RADIO-ELECTRONICS

25 West Broadway, New York, N. Y.

94

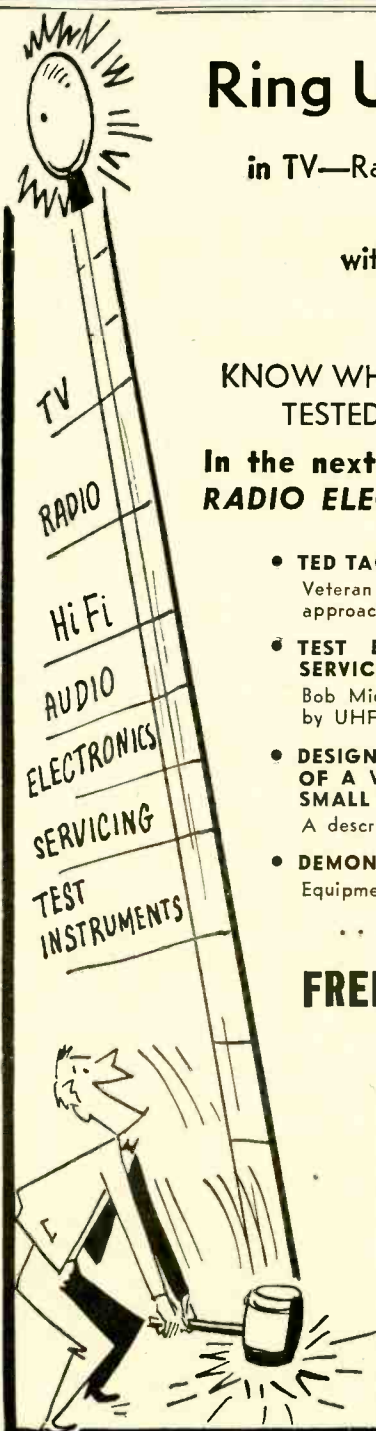

TECHNICIANS' NEWS

UTAH WANTS LICENSES

In reply to a recent questionnaire circulated by the Utah Association of Radio and Television Servicemen (see RADIO-ELECTRONICS, August, page 90), service technicians of the Salt Lake City area have expressed a majority preference for State licensing.

The association is now working with city officials and representatives of the local business men's association to draw up a bill which they expect to present to the Legislature next January.

HOW TO ORGANIZE

Telling radio technicians how to organize a local TV-radio-electronics service association, the National Alliance of Television and Electronic Service Associations has issued what may be to the servicing fraternity the most important document of the year.

Called "Here's How" the booklet is a collection of mimeographed sheets stapled into a 4-page folder which serves both as a cover for the book, and to carry a plea for affiliation with NATESA. Three pages then carry a step-by-step plan—in 12 steps—on the actual work of organizing a local association.

Sheets showing a suggested constitution and by-laws, samples of promotional material, questionnaires, and membership applications follow. These are based on forms used by NATESA or TISA (the Television Installation Service Association of Chicago). There is also a short history of TISA, showing what a service organization can do for its membership and the community.

TECHNICIANS KNOW LAW

The San Antonio Radio and Television Association reports that members participated in a discussion "Law and How It Affects Your Business" by a local attorney at the June 22 meeting.

The discussion took place as a part of the General Electric business course now being conducted by the San Antonio association. The course is being handled in a slightly unconventional manner. Texts are used in class. Meetings discuss the subjects covered by the course—which the members study at home. Each meeting is led by a local authority on the subject discussed that evening and members put their home study to use in the discussion and question period.

An interesting by-product of the course is that some of the wives of members—who in San Antonio attend meetings regularly with their husbands—are said to be using the G-E business methods to set up household budgets and accounting systems.

LOOSE TALK

Technician to customer:

Yes, ma'am, you were perfectly right. It was only a loose wire—in the 27MP4!
—Long Island Guild News

**WE BUILT A NEW PLANT—
TREMENDOUSLY INCREASED OUR PRODUCTION—
BECAUSE:
THEY'RE CALLING FOR MORE and MORE
GOOD Line at BETTER PRICES
with BEST DELIVERY**

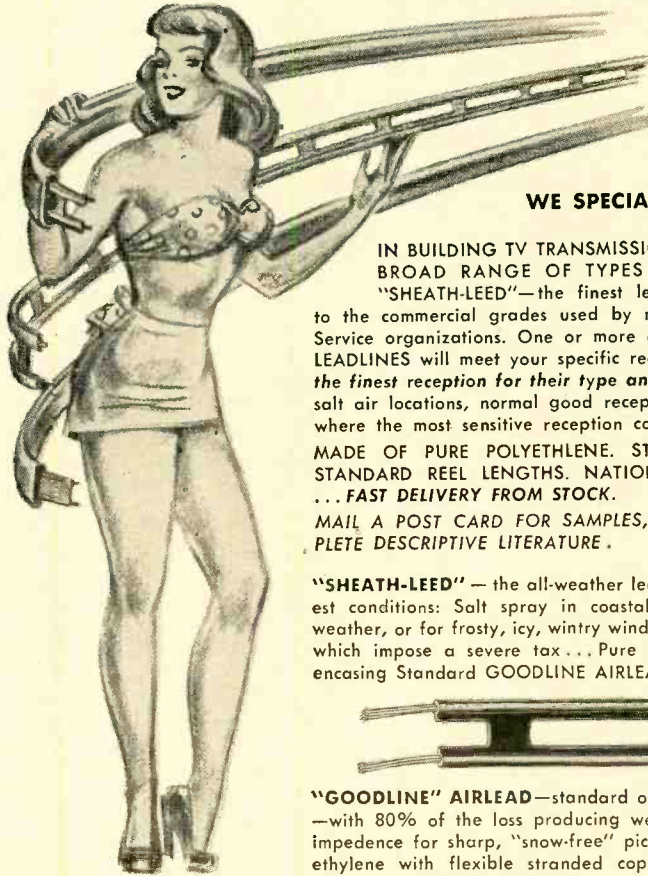

For UHF
and VHF

WE SPECIALIZE

IN BUILDING TV TRANSMISSION LEADLINES in a BROAD RANGE OF TYPES from GOODLINE "SHEATH-LEED"—the finest leadline ever built—to the commercial grades used by many TV Sales and Service organizations. One or more of the DON GOOD LEADLINES will meet your specific requirements. All give the finest reception for their type and price—whether in salt air locations, normal good reception areas or areas where the most sensitive reception conditions prevail. MADE OF PURE POLYETHYLENE. STANDARD COLORS. STANDARD REEL LENGTHS. NATIONALLY ADVERTISED ... FAST DELIVERY FROM STOCK. MAIL A POST CARD FOR SAMPLES, PRICES and COMPLETE DESCRIPTIVE LITERATURE.

"SHEATH-LEED"—the all-weather leadline for the toughest conditions: Salt spray in coastal areas; hot, humid weather, or for frosty, icy, wintry wind-whipping conditions which impose a severe tax... Pure Polyethylene Tubing encasing Standard GOODLINE AIRLEAD.



"GOODLINE" AIRLEAD—standard of leadline excellence—with 80% of the loss producing web removed. Correct impedance for sharp, "snow-free" pictures. Of pure polyethylene with flexible stranded copper-clad conductors. MANY IMPORTANT FEATURES.

NEW FULL-WEB "SHEATH-LEED"—the pure polyethylene of "SHEATH-LEED" and full characteristics of GOODLINE AIRLEAD—but NO PERFORATED WEB. No 20 (7 strand 28) copperweld wire in pure electronic golden clear polyethylene—with a pure silver-gray polyethylene sheath overall—for Maximum Weather Protection.

Don Good, INC.

SOLD BY LEADING
JOBBER & DEALERS

1014 FAIR OAKS AVENUE—SOUTH PASADENA, CALIFORNIA

Hey!
SEE THE NEW
PRINTED
CIRCUIT
Heathkit
VTVM
with P-P Scales

PAGE 71

**BUY DIRECT
MANUFACTURER TO DEALER**
ANTENNAS-INSTALLATION
HARDWARE AND ACCESSORIES
WRITE FOR CATALOG

Skysweeper inc.
P. O. BOX 68
McHENRY, ILL.

Handle Tough Service Jobs

AS "SLICK" AS YOU DO THE EASY ONES!

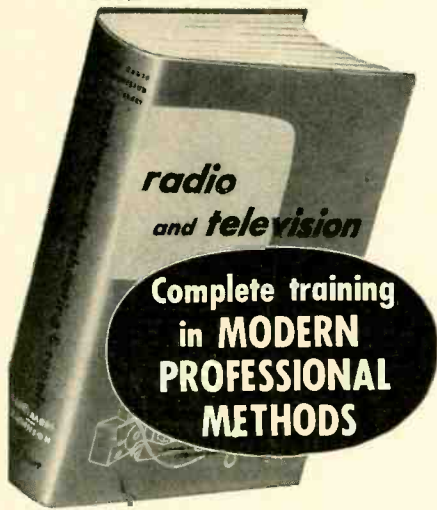

FIX ANY RADIO OR TV SET EVER MADE . . .

Easier . . . Better . . . Faster

How to troubleshoot the professional way

• AM, FM and TV realignment made easy

• Testing tips and ideas

• A complete guide to TV service

• Component problems and how to solve them

• Special problems in Battery Sets, Communications Receivers, Recorders, etc.

• Servicing, tuning and switching mechanisms.

• . . . and dozens of other subjects

Owning this big, up-to-the-minute book is like having two of the world's greatest electronic experts standing by your side on every job . . . telling you just what to do, exactly how to do it!

Written by Ghirardi and Johnson, Radio & Television TROUBLESHOOTING AND REPAIR is a complete guide to modern professional methods . . . the kind that pay off big.

Step by step, it takes you through service procedures . . . from locating troubles fast and with less testing to making repairs accurately and promptly.

For beginners, this giant book is a complete service training course . . . at only a fraction of the price you might expect. For experienced servicemen, it is the ideal way to "brush up" on specific jobs; to develop better methods and shortcuts; and to find quick answers to problems that will enable you to handle tough jobs as fast and accurately as you now handle the easy ones.

Contains 820 big pages. Over 400 pictures, diagrams and charts make things doubly clear.

Remember! More men now in good servicing jobs get their training from Ghirardi books than any others of their type . . . and this new book is the latest and greatest of them all! Practice from it for 10 full days AT OUR RISK!

EXAMINE IT FREE!

Dept. RE-94, RINEHART & CO., Inc.
232 Madison Ave., New York 16, N. Y.

Send Ghirardi's new Radio & TV TROUBLESHOOTING AND REPAIR book for 10-day FREE EXAMINATION. If I decide to keep book, will then promptly remit \$6.75 (plus a few cents postage) in full payment. If not, I will return book postpaid and owe you nothing.

Name

Address

City, Zone, State.....
OUTSIDE U.S.A.—Price \$7.25 cash with order.
Money back if book is returned within 10 days.

TECHNICIANS' NEWS

GUILD HAS NEW EDITOR

The Editor-in-Chief of the Long Island *Guild News*, Murray Barlowe, has resigned his position to enable him to concentrate on his duties as Director of Lecturing and chairman of the Technical Committee. Ralph Milne is the new Editor. The post of corresponding secretary, formerly also held by Barlowe, is now being held by Chris Stratigos

Guild business included reports on the color television lectures being held in Queens, cooperation with the government's plan for selenium salvage by turning scrap rectifiers in to Sarkes Tarzian, and extension of the president's and vice-president's powers to meet the requirements of the Guild's rapid expansion. A committee which had visited a local distributor reported on his company's policy with respect to strict wholesale selling.

TRIPLETT HONORED

A plaque reading: "Very best wishes to Ray L. Triplett on completing his 50th anniversary as president of the Triplett Electrical Instrument Co. of Bluffton, Ohio. His outstanding leadership and direction of the company during this long period has been characterized by wisdom, understanding and a cooperative attitude, reflecting the



finest traditions of the electrical industry", was presented to him recently by NATESA. President Frank Moch made the presentation.

Shown in the photograph, left to right, are Ray Braun, president of the Associated Service Companies of Cincinnati, Mr. Moch, Mr. Triplett, and John W. Hemak of Minneapolis, NATESA treasurer. END

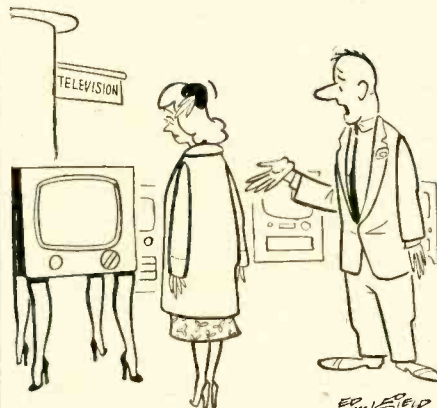

"Uh—let me show you something else, Ma'am—that's for a bachelor apartment!"



ON 3-WAY Portable KITS" and other KITS and WIRED UNITS



3-Way Portable RADIO KIT AC/DC Batteries

NEW, compact, lightweight portable radio kit with the very latest supersensitive superhet. circuit. Wonderful reception from either batteries, or 115 V., 50-60 cycle AC or DC. Includes all complete parts (except wire & solder) necessary to build a great sounding radio. Also includes circuit diagrams and simplified, complete step-by-step instruction folder which makes assembling easy. Housed in a beautifully high-glossed Catalin cabinet in two delightful and distinctive colors, maroon, or alabaster (Ivory). Size: 9 1/2" x 5 7/8" x 4 3/4". Includes tubes! **\$13.95** (maroon or Ivory)

BATTERY KIT: add..... **\$2.59**

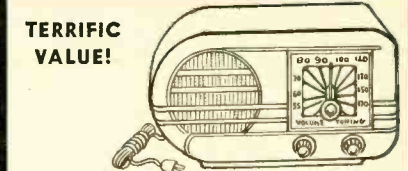

TERRIFIC VALUE!
5 TUBE AC/DC Superhet Kit
Kit #1: 5 tube superhet kit, AC/DC includes all quality components required to construct this latest design, highly sensitive superhet broadcast receiver, complete with black, distinctive bakelite cabinet (excludes wire & solder). Kit of 5 tubes. 12AT6, 2 I2-BAG, 12BE6, 35W4, 50B5. **\$7.95**
Price, Less Tubes..... **\$3.25**
Extra for Tubes..... **\$3.25**

Great Savings!
6-TUBE RADIO KIT
Kit #2: Low priced 6-tube kit designed for extra high sensitivity, excellent selectivity and good, rich tone quality. Uses 251L, 252B, 68Q7, 6SA7, 2/6SK7 in an easily constructed circuit. Includes all parts: punched chassis, resistors, condensers, coils, sockets, FM speaker, hardware, etc. **Special closeout price. (Less tubes & cabinet) \$6.95**
Matched set of 6 tubes for kit..... **\$3.25**

3 TUBE PHONO AMPLIFIER
NOT A KIT
An assembled unit ready for installation using tone and volume control and 6 ft. rubber \$2.95 cord, (less tubes)
Lowest Price!
With complete set of tubes..... **\$4.45**
Phono Oscillator
NEW SAVINGS! NOT A KIT!
Wireless phono oscillator transmits recording for crystal pickups or voice from carbon mike through radio without wires. Can also be used as an intercom by using FM speaker as mike (less tubes) **\$2.95**
With complete set of tubes..... **\$3.95**

PRECISION RESISTOR KIT
Consists of 50-10% Wilkor carbonfilm resistors of 50 different ohmmages, housed in a transparent plastic box. May be combined in series or parallel to produce almost any desired ohmage. Each resistor retails for about 85c. Terrific Cash Saver!
Kit of 50only **\$2.45**

TERMS: All misc shipped FOB New York City, prices subject to change without notice. Include 20% deposit for COD's. WRITE TODAY FOR NEW FREE CATALOG!

EDLIE Electronics
154 Greenwich Street
New York 6, New York
DI 9-3143

A new
dimension
in price and
performance

WALSCO

Scotty

377

LIST

GUARANTEED FOR 1 YEAR

**Greatest Antenna
Value in America**

The new "Scotty" has every quality feature necessary for crystal-clear reception in metropolitan and suburban areas. Good gain and directivity on all VHF channels. Used effectively for UHF, or as a combination antenna. Tested and approved for color reception.

COMPARE

WALSCO "Scotty"	3.77
Antenna B	7.50
Antenna C	4.86
Antenna D	5.40
Antenna E	4.60

Place your order today

Easily
stacked for
semi-fringe
reception



ELECTRONICS CORPORATION

3602 Crenshaw Boulevard, Los Angeles 36, California

Export Distributor:
AD AURIENA, Inc., 25 Broad St., New York 4, N.Y.

ALL RADIO AND TV TYPES

TUBES

CLOSE OUT!
SET MANUFACTURERS

CLOSE OUT

ONE OF AMERICA'S
LARGEST
WHOLESALE

- STANDARD BRAND WARRANTY
- BRANDED
- BULK PACKED OR INDIVIDUALLY BOXED

0A4G	60	3Q4	48	6CR6	42	7K7	80	14C5	80
0Z4	53	3Q5GT	48	6CD6G	1.05	7L7	77	14C7	65
1A4P	35	3S4	46	6E5	76	7N7	57	14E6	65
1A7GT	45	3V4	50	6F6	45	707	57	19A	45
1B3GT	67	5U4G	49	6J6	50	7R7	59	19BG6G	1.15
1C5GT	40	5V4G	76	6J7	49	7S7	83	19T8	75
1C7G	37	5Y3G	39	6K5GT	39	7W7	87	22	40
1E7GT	35	6AG	45	6K7C	38	7W7	85	25AV4GT	80
1F4	40	6AB7	71	6L6GA	39	7X6	57	25B06GT	75
1F5G	44	6AC7	68	6S4	74	7Z4	40	25L6GT	40
1H4G	40	6AG5	47	6SA7	40	7Z4	45	25Z6GT	40
1H5GT	38	6AH6	88	6SC7	75	12A6	49	32L7GT	95
1L4	45	6AK5	59	6SF5GT	45	12A7	58	35C5	37
1L6	61	6AL5	42	6SG7	40	12A7G	35	35L6GT	45
1L4A	59	6AQ5	39	6SH7	60	12A7P	62	35W4	44
1LAG	75	6AQ6	36	6SJ7	54	12AU7	59	35Z3	40
1L6G	49	6A7G	68	6SL7GT	49	12AU7	59	35Z5GT	45
1L8	77	6A7GT	68	6SN7GT	48	12AV7	64	35Z5GT	45
1L83	75	6AV5GT	79	6SR7	45	12AX7	55	36	35
1L85	75	6AV6	36	6T8	57	12AV7	72	37	35
1LNS	55	6BA6	38	6U8	59	12BA6	47	39-44	35
1LNS	55	6BA6	38	6W4GT	41	12BA7	59	46	45
1NSGT	61	6BR7	38	6W6GT	41	12BD6	46	47	85
1R4	59	6B8A	45	6X4	35	12BE6	45	49	85
1R5	47	6B8C	49	7A4	45	12BH7	60	50L6GT	61
1S4	55	6BE6	37	7A7	65	12H6	45	50X6	62
1S4	55	6BFG	69	7B5	55	12H6	45	50Y6GT	57
1S4S	40	6BG6G	1.15	7C7	65	12SA7GT	62	50Y6GT	57
1T4	46	6B16	41	7E5	59	12S07	70	51	1.40
1U4	46	6B17GT	65	7E6	40	12S07GT	53	9003	1.30
1U5	40	6B8G	71	7F7	54	12S07GT	53	9003	1.30
2A5	49	6BQGT	73	7F8	90	12SH7	70	11723	.38
2A7	60	6BQ7	88	7G7	80	12SN7GT	50	11726GT	.70
2X2	39	6C4	35	7H7	56	12SQ7GT	53	9003	1.30
3LF4	71	6C6	54	7J7	75	14A7	53	814	1.25
						14A7F	53	807	3.50
						14B6	45	836	7.95
								866A	1.45

MINIMUM ORDER: \$10.00. Terms: 25% with order, balance C. O. D. Please include postage.
All prices subject to change without notice. F. O. B. New York City. Mail Order Division:

TRANSAMERICA ELECTRONICS CORP.

115 LIBERTY ST., NEW YORK 6, NEW YORK

HERE'S HOW TO GET YOUR START IN RADIO ELECTRONICS

More experts got their basic training from this big book than any other of its type!

Here's basic training you can really understand... training that can help fit you for a good pay radio-television-electronic career!

RADIO PHYSICS COURSE by A. A. Ghirardi

Complete, basic training for beginners

Starts with Basic Electricity (over 300 pages) then takes you step by step through the entire radio-electronics field. Covers principles, theories and practices that are basic to even the most modern equipment. 972 pages; 508 pictures. 856 helpful self-review test questions. Price only \$6.50.

RADIO PHYSICS COURSE
by A. A. Ghirardi

---STUDY 10 DAYS FREE!---

Dent, RE-94, RINEHART & CO., INC.,
232 Madison Ave., New York 16, N.Y.

Send Ghirardi's RADIO PHYSICS COURSE home-training book for 10 days free examination. I will then either return book promptly or send you \$6.50 plus postage in full payment.

Name

Address

City, Zone, State.....

OUTSIDE U.S.A.—\$7.25 cash only. Money back if book is returned in 10 days.

TV GLO-TEST

Replaces \$279 in
TESTING EQUIPMENT

This is the instrument that appeared in feature articles in RADIO-ELECTRONICS and other publications. GLO-TEST is the sensational new tester that almost talks! For TV and Radio servicemen, Sound Technicians, Amateurs, Experimenters, Electricians.

\$14.50

OVER 50 USES, INCLUDING—
PIXTUBE TESTER—AC-DC. VOLTAGE MEASUREMENTS TO 50 KV—SIGNAL GENERATOR—SIGNAL-TRACER—TUBE TESTER—RESISTOR AND CAPACITOR MEASUREMENTS—DISTORTION AND LINEARITY CHECKER. ACCURACY COMPARABLE TO VTVM. FULLY GUARANTEED.

Replaces instruments costing many times its cost, does a comparable job yet is only a small fraction of their total weight and size. GLO-TEST, complete with test leads and instruction booklet, postpaid, is priced at only \$14.50.

Send check or money order. 10-day money back guarantee. Free literature on request.

V. A. ENTERPRISES, Dept. AA
608 East Rosecrans Blvd., Compton, Calif.

HI-GAIN TUNER-BOOSTER

LESS TUBES WITH DIAL

\$2.00

COMPLETE WITH TUBES

\$2.75

Solve Poor TV reception with a Hi-Gain Booster. Banish weak fringe areas, reduce snow. This unit comes to you as a highly serviceable High-Gain Tuner. Uses 6J6 Tubes in very efficient H-G Circuit. Has 8 tuned circuits using pure silver inductances and individual compensation providing high gain on all channels. Built in 5.1 Vernier Drive. All necessary parts and instr. included. Add postage for 5 lb. shipping wt. No C.O.D.'s. Send for TV parts bulletin.

FRANK W. DECRAY & ASSOC.
11842 W. Jefferson Blvd. Culver City, Calif.

NEW DESIGN

new tubes

and Transistors

An important advance in the development of color TV picture tubes has been announced by CBS-Hytron. The CBS-Colortron 205 is a 19-inch, aluminized, round glass-envelope unit. It has been given the RETMA designation 19VP22.

Using the CBS method of screen processing, the tri-color, phosphor-dot screen is placed directly on the inside surface of the spherical face plate, providing a large useful screen area of 205 square inches. The length is 26 7/16 inches.

The tube's three matched electron guns are each tilted toward the tube axis, for better convergence, which is also aided by three pairs of pole pieces mounted 120° apart above the anode, forming part of the dynamic convergence magnetic circuit. The tube operates with an anode voltage of 25,000.

The first commercially available silicon transistors (see photo) have been announced by Texas Instruments,



Dallas. The types are the 900 and 901 general purpose units designed for high-gain low-level audio applications, and the X-15, for medium-power use.

Raytheon and RCA have announced the 17-AP4, a monochrome picture tube using low-voltage electrostatic focusing and magnetic deflection. The 17AP4 has a screen area of 145 square inches and a deflection angle of 90°.

The 21ALP4-A direct-view, rectangular glass picture tube has been announced by Raytheon and RCA. The tube has a 90° deflection angle and uses low-voltage electrostatic focus and magnetic deflection. It has a metal-backed screen and a screen area of 263 square inches.

END

**BLAK-RAY SELF-FILTERING
ULTRA-VIOLET LAMP**



BLAK-RAY 4-watt lamp, model X-4, complete with U-V tube. This lamp gives long-wave ultra-violet radiation having a wave-length of 3654 to 4000 angstrom units. Some of the substances made to fluoresce visibly when illuminated by U.V. light are certain woods, oils, minerals, milkstone, cloth, paints, plastics, yarn, drugs, crayons, etc. This lamp is self-filtering and the invisible U-V rays are harmless to the eyes and skin. Equipped with spectral-finish aluminum reflector. Consumes only 4 watts and can be plugged into any 110 volt 50-60 cycle A.C. outlet. Will give 2000 to 3000 hours of service. It weighs but 1 3/4 lbs. Approved by the Underwriters Laboratories and has a built-in transformer so that it may be safely used for long periods when necessary. Extra U-V tubes are available.

Ship wt. 4 lbs. **\$16.75**
ITEM NO. 125
UNUSUAL BUY (Shp. Chgs. 70c)

POWERFUL ALL PURPOSE MOTOR



Sturdy shaded pole A.C. Induction motor. 15 watts, 3000 rpm. 3"x2"x1 3/4"; 4 mounting studs; 7/8" shaft, 3/16" diameter; 110-120 volts, 50-60 cycles. A.C. only. When geared down, this unit can operate an 18" turntable with a 200 lb. dead weight. Use it for fans, displays, timers and other purposes. Ship wt. 2 lbs.

\$2.45
ITEM NO. 147
UNUSUAL BUY (Shp. Chgs. 35c)

WATTHOUR METER

Leading makes—reconditioned. Ideal for trailer parks. 100-110 volts, 60 cycles, 2-wire A.C. 5 amp. Heavy metal case 8 1/2" x 6 1/4" x 5". Easy to install. Ship. wt. 14 lbs.



ITEM NO. 33 **\$4.50**
NOW ONLY (Shp. Chgs. \$1.25)

WESTERN ELECTRIC BREAST MIKE



Lightweight 1 lb. carbon microphone. Aircraft type. Breastplate mounting, adjustable 2-way swivel. Easily fastened straps. For home broadcasts, communications etc. Complete with 6 foot cord, hard rubber plug. Sherardized plate, non-rusting finish. Ship. wt. 2 lbs.

ITEM NO. 152 **\$1.98**
NEW LOW PRICE (Shp. Chgs. 32c)

AMAZING BLACK LIGHT



250-watt ultra-violet light source. Makes fluorescent articles glow in the dark. Fits any lamp socket. For experimenting, entertaining, unusual lighting effects. Ship. wt. 2 lbs.

ITEM NO. 87 **\$2.45**
A SAVING AT (Shp. Chgs. 35c)

250 POWER TELESCOPE LENS KIT

Make your own high powered 6 ft. telescope! Kit contains 2" diam., 75" focal length, ground and polished objective lens and necessary eye pieces. Magnifies 50x to 250x. Full instructions. Ship. wt. 1 lb.

ITEM NO. 123 **\$2.95**
YOU SAVE AT (Shp. Chgs. 10c)

HUDSON SPECIALTIES CO.
25 West Broadway, Dept. RE-9-54
New York 7, N. Y.

I am enclosing full remittance for items circled below. (Be sure to include shipping charges.)

OR, my deposit of \$..... Ship balance C.O.D.
MINIMUM C.O.D. ORDER \$5.00.

C.O.D. ORDERS ACCEPTED ONLY WITH 20% DEPOSIT
INCLUDE SHIPPING CHARGES.

Circle Items Wanted
87 147 33 152 125 123

Name
Please Print Clearly

Address

City Zone State

ROHN *the Foremost Name
in TV Towers...*

**2 PRESENTS
new additions**

**the "PACKAGE"
TOWER**

The "Superiority" secret is in the "magic" triangle!

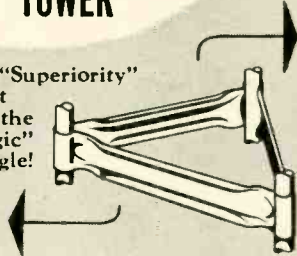

The answer to your storage space dreams — reduced freight rates give you the edge on competition!

PAT. PENDING

Both towers are self-supporting and have all the Rohn "Superior Design" features that make the Rohn line truly proved in performance and nationally accepted!

**the NO. 6
TOWER**

Built to fill 75% of your requirements — structurally as sound as the Rohn Standard No. 10 Tower — yet costs less!

These new Rohn Towers continue to feature the famous triangular design, the self-supporting features and the simplicity of design which gives extraordinary ruggedness and durability! New, advanced Rohn designing utilizes mass production machinery to greatly lower cost — yet actually produce a tower structurally sturdier than before! Get full facts today on Rohn Towers that are loaded with "Sales Appeal" . . . so far advanced in design and engineering to be truly years ahead!

See your authorized Rohn Representative or Distributor for catalog sheets and complete details. Or . . . write, phone or wire . . .



MANUFACTURING CO.
DEPT. RE 116 LIMESTONE BELLEVUE
PEORIA, ILL.

"Pioneer designers and manufacturers of towers of all kinds . . . sold with assurance and satisfaction coast-to-coast!"

Audiorama 1954
Presented by **THE AUDIO FAIR**

More than 125 manufacturers, from all over the world, will exhibit and demonstrate their products — the finest components, equipment and accessories. Their representatives will answer your questions and help you with your audio problems. AUDIORAMA 1954 is for broadcast engineers, sound-on-film men, governmental, military and municipal agencies, business and industrial purchasing agents — for everybody interested in quality sound reproduction.

AUDIORAMA 1954 is presented by THE AUDIO FAIR
Harry N. Reizes, Managing Director, 67 W. 44th St., N. Y.
An AUDIO FAIR-VIDEO FAIR, INC. Project

**NO
ADMISSION
CHARGE
YOU ARE
INVITED**

FOUR DAYS
Oct. 14, 15, 16, 17

FOUR FLOORS
5th, 6th, 7th, 8th

Hotel New Yorker
New York City

1 to 10 P.M. Daily
Sun. 12 Noon to 6 P.M.

SPONSORED BY

FO8AJ

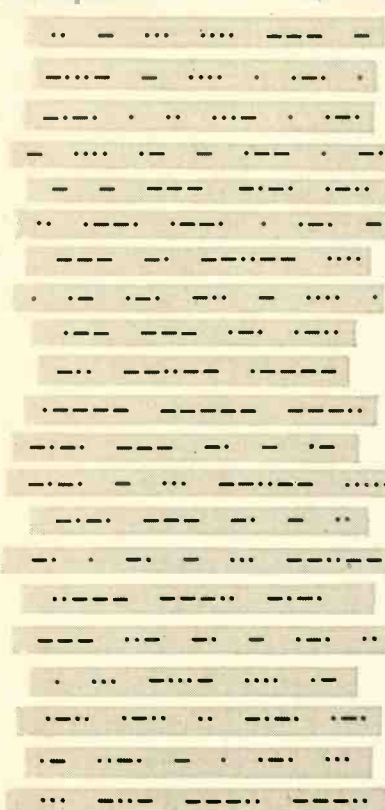

hallicrafters

CHICAGO 24, ILLINOIS



MAIL THIS COUPON

FREE—Send me World-wide Time Conversion Dial Calculator and all band frequency allocation chart plus a fund of other handy data.

Name _____

Address _____

City _____ State _____

Ham (call letters _____) Listener

Occupation _____

Hallicrafter equipment I would like to know about: _____

TECHNOTES

RCA KCS-83 SERIES CHASSIS

Oscillations in the sound i.f. circuits of these chassis may be caused by a change in the value of the .01- μ f screen bypass capacitor (C101-b) in the first sound i.f. stage. A defective capacitor at this point allows the first sound i.f.

and C101-b. Replace C101-a with a .01- μ f positive temperature-coefficient type (RCA stock number 73960) and C101-b with a .001- μ f positive temperature-coefficient type (RCA stock number 78623). Note that the replacement

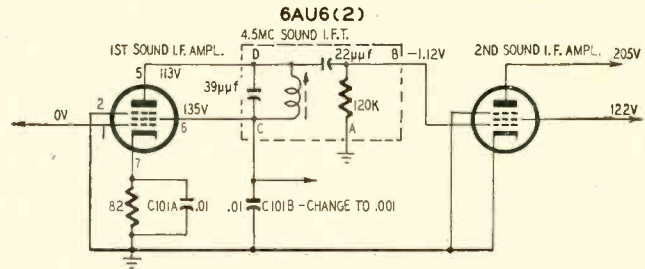

to oscillate within the range of 2 to 3 mc and cause raspy sound and a beat pattern in the picture.

Two replacement capacitors are recommended for dual capacitor C101-a

for C101-b is a .001- μ f type where the original value was .01 μ f. Keep the bypass capacitor leads short and make the connection to the same points as the original parts.—*RCA Service*

CHEVROLET 985793 AUTO SET

The set played normally on distant stations. On strong local stations the signal was distorted with an intermittent rasping noise. Using a signal tracer and a strong unmodulated signal from

indicated by the values on the partial schematic.

A further check showed that the mica insulation in the antenna-to-grid coupling capacitor (a part of the antenna

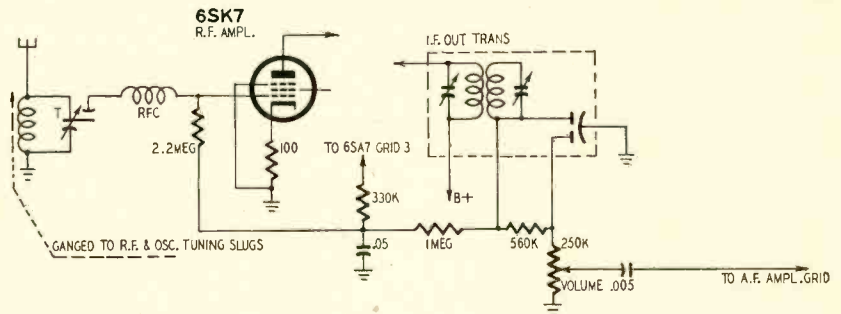

a signal generator, we localized the trouble in the r.f. stage. A resistance check from the grid of this stage to ground showed 100,000 ohms. The normal resistance is 3.7 to 4 megohms as

trimmer) had shattered and was partially shorted.

The set was restored to normal operation by replacing the mica insulation.—*Floyd Holton*

INTERMITTENT 12SA7'S IN A.C.-D.C. SETS

Check heater voltages when tubes test good in intermittent a.c.-d.c. sets. In two cases, I traced intermittents to

“good” 12SA7's drawing only 7-9 heater volts. New tubes cured the ills.—*Alfred Hollinden*

ARVIN SERIES 9200 TV SETS

Horizontal wavering in the top one-third of the picture on these sets (chassis TE-355, -358, -359, -362, -364, and TE-357) may be caused by intermittent partial loss of horizontal sync pulses when the set receives piped-in r.f. signals from a faulty multiple-dwelling or community antenna system. This wavering does not occur on a normal sig-

nal into a separate antenna. When this condition prevails the trouble can be cleared up by inserting a parallel R-C network consisting of a 270- μ f mica capacitor and a 270,000-ohm, 1/2-watt resistor in the line to the sync separator. The diagrams show the original and modified circuits.—*Arvin Service Bulletin*.

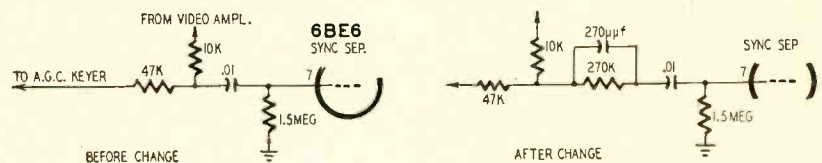

TECHNOTES

MOTOROLA 17K5E

The set worked normally for about an hour and then began losing height, intermittently with the picture shrinking to a line about one-quarter inch high. All components in the vertical oscillator and output checked normal. The set was turned on again. After

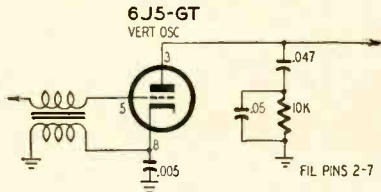

about an hour of normal operation, a faint ticking sound was heard coming from the .047- μ f, 400-volt vertical discharge capacitor connected to the plate of the 6J5-GT vertical oscillator as shown in the diagram.

This capacitor was normal when the set was cold but began to break down when it warmed up. Replacement with a 600-volt unit of the same capacitance cured the trouble.—*Michael L. Tortariello*

ZENITH CHASSIS 5537

When this 3-way portable is dead and all voltages and parts check O.K., the trouble may be a high-resistance short between the chassis and the metal-clad wirewound resistor on top of the chassis. This resistor supplies 6 volts to the four 1.4-volt tubes. The short to chassis increases the current drain and drops the voltage to less than 4.

Replace the defective unit or insulate it from the chassis.—*Geo. R. Anglado*

POWER LINE ARCING?

In the "TV Service Clinic" of last November, a reader described TVI in the form of two dark horizontal bands across the screen on channels 2, 4, and 5. The reader believed, and Mr. Mandl agreed, that the trouble was probably caused by corona discharge from nearby high-tension power lines.

I have experienced at least three cases of TVI with exactly the same symptoms. The cause of this trouble turned out to be an oscillating 117-volt light bulb. In two cases the bothersome lamp was located in the same building with the TV receiver.

I'll bet that reader J. M. has the same trouble.—*A. F. Popelarski*

A.C.-D.C. MOTORBOATING

Although motorboating is comparatively uncommon in modern 5- and 6-tube a.c.-d.c. radios, we do run across a set with this complaint from time to time. In every case so far, the trouble has been caused by common coupling through the power supply circuit and has been eliminated by installing a 4,700-ohm decoupling resistor and a .05- μ f bypass capacitor in the B plus lead to the primary of the second i.f. transformer.—*Wayne Miller* END

your customers want the BEST!...the "ORIGINAL"

MOSLEY

Wall

Thru



CONVENIENT
LOW LOSS SOCKET
MAY BE INSTALLED
ON INSIDE PLATE

POLYSTYRENE
THRU-OUT! FULL
1/8" THICK WALL
- BEST FOR UHF,
VHF, COLOR

TAKES ALL
POPULAR LINES!
RUBBER GROMMET
SEALS OUT
MOISTURE!

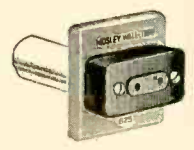

Cat. No. 625
MOSLEY WALL-THRU,
in brown or ivory.
List Price \$1.95

Cat. No. 625-PK
WALL-THRU, with
Universal TV Socket
& mating Plug.
List Price \$3.00

Write for free copy of MOSLEY Condensed Catalog, Form D-1. Tells - How To Make More Installation Profits!

Mosley
Electronics, Inc.
8622 ST. CHARLES ROCK ROAD
ST. LOUIS 14, MISSOURI

A Word Of Caution!

Because there are numerous imitations, similar in appearance to the popular Wall-Thru, the TV installer is cautioned to ask for the Original MOSLEY Wall-Thru - by name!

For Quality, Value, Practical Design - insist upon the MOSLEY Wall-Thru . . . Another PREMIUM QUALITY MOSLEY Accessory for Better, More Profitable TV Installations!

SAVE MONEY.. MAKE MONEY..

LEARN TV

the practical way..



ASSEMBLE A
**TRANSVISION
TV KIT**

Pay as You Wire \$**39**
Down Payment

I WILL HELP YOU to start learning TV the practical way - by assembling a TRANSVISION TV KIT in EASY STAGES. For only \$39 you get PACKAGE #1 (standard first pkg. for all of our kits). This package gives you the BASIC CHASSIS and over 450 TV COMPONENTS with complete Instructions, Drawings, Photos, Service Booklet, and a year's subscription to my "TV and Electronics Notes". When ready, you order the next stage (pkg. #2), etc. Low prices make your complete kit a terrific buy!



FREE CATALOG Shows 6 Great TV Kits:
EXCLUSIVE: Only Transvision TV Kits are adaptable to UHF. Ideal for FRINGE AREAS. No Previous Technical Knowledge required. Write now!
TRANSVISION, INC., Dept. E9
NEW ROCHELLE, N. Y.

--- MAIL THIS COUPON TODAY ---
Educational Director
TRANSVISION, INC., NEW ROCHELLE, N. Y. Dept. E9
 I'm enclosing \$_____ deposit. Send standard kit PACKAGE #1, with all Instruction Material. Balance C.O.D.
 Send FREE copy of your new TV Kit Catalog.
Name _____
Address _____
City _____ State _____

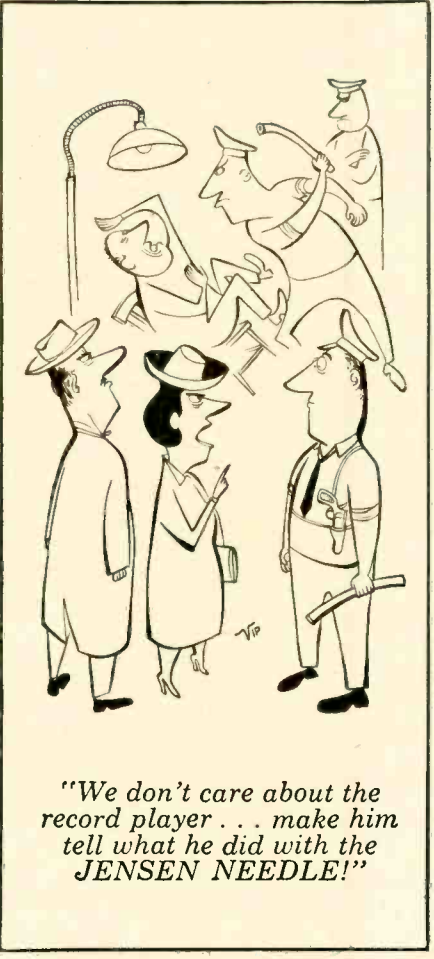

"We don't care about the record player . . . make him tell what he did with the JENSEN NEEDLE!"

Inventory

OF EQUIPMENT AT

Western Union Telegraph Co.
Development & Research Dept.
Electronics Research Div.
Water Mill, N. Y.

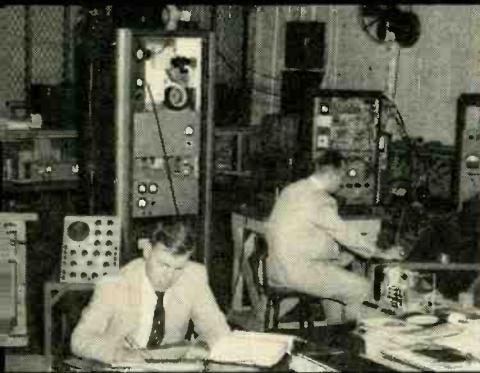

INCLUDES **13**
hallicrafters
RECEIVERS



HALLICRAFTERS SX88

Wherever world wide, all band radio reception is important and reliability of receiver performance paramount, there is bound to be **HALLICRAFTERS!** The radio man's radio.

*Used by 33 governments,
sold in 89 countries.*

hallicrafters

CHICAGO 24, ILLINOIS

MISCELLANY

THE FUND REACHES
\$11,445.11



HELP-FREDDIE-WALK FUND

We here at RADIO-ELECTRONICS have had some wonderful reports about little Freddie Thomason, six year old, armless and legless son of radio technician Herschel Thomason, of Magnolia, Ark., and we are more than happy to bring them in turn to you. His father writes:

"I have the best news that I have been able to write you in a long time. Freddie is now walking and is doing a real nice job of it. He can walk all over the house, so his Mother puts a football helmet on him almost every morning and lets him go. He usually walks for about three hours before he



Freddie and his friends watch TV

gets tired. I will be writing you more about his progress later."

As most of our readers know, for many years Freddie will be dependent upon special devices to get the exercise and education he needs to prepare him for a self-reliant adulthood. All contributions to the Help-Freddie-Walk Fund have been sent on to Herschel Thomason, who then turns them over to a General Fund. \$15,000 of this fund has been set aside on a time deposit and is drawing interest. A smaller fund has been set up to be used for immediate expenses.

Recently, we received the welcome news that a special room has been added to the Thomason house for Freddie's personal use, using these "immediate" funds. Mr. Thomason writes:

"Please express to your readers our appreciation for their part in helping to build the room. The addition, built at a cost of about \$2,300, was badly needed for Freddie's present and future convenience. We hope in the future to equip it with special devices for exercise and education."

RADIO-ELECTRONICS readers will be proud of the part they have had in

!! TUBES... UP TO 90% OFF !!

90 DAY GUARANTEE! Standard Brands, unsealed cartons. STOCK UP NOW! THOUSANDS OF OTHER TUBES AVAILABLE AT SAME SAVINGS!

#24, 26, 27, 34, 41, 42, 55, 56, 89 or 9K7...ea. 29c
#1A6, 1C6, 1H4, 1H6, 1J6, 5Y3, 5Y4, 6B7, 6C5, 6F5, 6G5, 6G6, 6SD7, 6SQ7, 6RT, 6Y3, 76, 77, 78, 80, VT-52, 1B19...ea. 39c
#01A, 024, 1A7, 1L4, 6AR, 6AU6, 6CB6, 6FB, 6H8, 6J8, 6SA7, 6SK7, 6W4, 7A4, 7AT, 7AG7, 7B8, 7C5, 7C6, 7G7, 7J4, 12SN7, 25L6, 35, 37, 39/44 or 45...ea. 49c
#1B3, 1LA6, 1LC6, 1LH4, 1LE5, 2A6, 2A7...ea. 69c
6AG, 6AG, 6AK5, 6B8, 6AC7, 6L7, 6SC7, 6SP5, 6T8, 6U7, 7C7, 12A6, 47, 50, 5B or 81...ea. 69c
#0C3, 0D3, 6BG6, 6L6, 7H8, 7Q7, 10B0, VT-5, 574...ea. 89c

G-E TUNGAR BULBS #206501 (2 Amps) \$1.75 #289881 (.6 Amp) 1.49

PHILCO TV TURRET TUNER (Pt. #78-3109, less coil, contact strips), For '48 & '49 models...1.49
Above Tuner with 3 socket wired RF strip...1.98
18 FT. WHIP ANTENNA, 6 steel tapered screw sections...\$3.75 Extra Extension Sections...ea. 75c
RADIO HARDWARE TREASURE... FULL LB. CAN of Nuts, Screws, Washers, Lugs, etc...ea. 89c 3 lbs. 2.49
CRYSTAL MIKE... Hi-fidelity, hi-imped. Rubber shock mtd. (1 3/4" x 1/4"). Less housing...1.29
ALUMINUM HOUSING for above mike...1.15
HANDY CARBON MIKE... 100 ohm S.B. 51c
rubber cord & plug. 200 ohm S.B. \$2.49

KITS!! KITS!! KITS!!

WHOPPING VALUES FOR EVERYONE!!
RELAYS incl. multi-contact & midget keying types. Kit of 5 assorted...2.49
RF-ANT-OSCILL. COILS... std. b'cast & S.W., incl. shielded types. Kit of 10 assorted...98c
MOLDED BARLEITE CONDENSERS... 50mm to .2mtd. 200-600V. Kit 50 asstd...\$1.98 100/\$2.98
RADIO-TV BUILDERS' LIBRARY... for Students, Home, Service, 25 asstd. Radio & TV schematics including Photofacts. Kit of 25 asstd...98c
TUBE SOCKETS... wifer. 4 to 8 pin. 12 asstd...49c
ROTARY SELECTOR SWITCHES... incl. multi-deck types. 1/4" shafts. Kit of 6 asstd...1.49
CARBON RESISTORS... 1/3-2 watt. 100 asstd...1.95



"DIRECT FACTORY SPEAKER REPAIRS SINCE 1927"
Min. Order \$3.00. 20% deposit req. on all C.O.D.'s. Full remittance with foreign orders. Please add sufficient postage—excess refunded.

LEOTONE RADIO CORP.
67 Dey Street
New York 7, N. Y.

Gov't Surplus PANEL METERS

0-200 Milliamp., G.E. Model DO-58, 4" square. Each...\$395

0-15 D.C. Milliamp., G.E. Model DO-58, 6" square... Each \$3.95

0-750 D.C. Milliamp., G.E. Model DD-6, 6" square... Each \$10.95

110 Volt, A.C. Relays, 2 N.O., 2 N.C. Contacts... Each \$3.95

28 Volt, D.C. Relays, 2 N.O. Contacts... Each 97c

Full Remittance Must Accompany Order
Postage Prepaid in U.S.A.

ZIDELL
MACHINERY & SUPPLY CO. (Elec. Div.)
3121 S. W. Moody St. • Portland 1, Ore.

SEE ALL Three

BRAND NEW

HEATHKIT

SCOPES

ON PAGE

69



When answering advertisements please mention **RADIO-ELECTRONICS**

RADIO-ELECTRONICS

MISCELLANY

making Freddie's progress to date possible. The bulk of the money in his General Fund has come from you, in contributions ranging from \$.50 to several hundred dollars. BUT—the job is only beginning—and the end isn't even in sight. Freddie is an otherwise healthy and normal boy. As he continues to grow and develop, all the special devices he needs will have to "grow" with him, and this will take money, thousands and thousands of dollars over the span of some fifteen or more years before Freddie will have reached his full growth.

We therefore ask that you continue sending in your contributions as often as you can. No amount is too small to receive our sincere thanks and appreciation, as well as the thanks and appreciation of the entire Thomason family. *Make all money orders, checks, etc., payable to Herschel Thomason.* Address all letters to:

Help-Freddie-Walk Fund
c/o RADIO ELECTRONICS Magazine
25 West Broadway
New York 7, N. Y.

FAMILY CIRCLE Contributions.....	\$ 602.50
RADIO-ELECTRONICS Contributions as of April 8, 1954.....	10,809.59
Anonymous, Northampton, Mass.....	1.00
Anonymous, Roseville, Mich.....	1.00
Anonymous, New York, N.Y.....	.50
Anonymous, Toledo, Ohio.....	1.00
Anonymous, Portland, Oregon.....	5.00
Fred M. Brenner, Dayton, Ohio.....	1.00
J. Salvador Donaire, Honduras, C.A.....	7.02
Dorn, Murrysville, Pa.....	1.00
Van H. Ferguson, Tallahassee, Fla.....	3.50
E. F. Long, General Electric Co., Schenectady, N.Y.....	1.00
Shirley Pinner, Hamilton, Ontario, Canada.....	1.00
Albert Steinberg & Co., Philadelphia, Pa.....	10.00

TOTAL CONTRIBUTIONS as of July 2, 1954 \$11,445.11

Radio Thirty-five Years Ago In Gernsback Publications

HUGO GERNSBACK Founder

Modern Electrics.....	1908
Wireless Association of America.....	1908
Electrical Experimenter.....	1913
Radio News.....	1919
Science & Invention.....	1920
Television.....	1927
Radio-Craft.....	1929
Short-Wave Craft.....	1930
Television News.....	1931

Some of the larger libraries still have copies of ELECTRICAL EXPERIMENTER on file for interested readers.

In September, 1920 Science and Invention (formerly Electrical Experimenter)

A Giant Radio Central Station
New de Forest Buzzer Radiophone
A Direct-Reading Microfaradmeter
How to Become a Professional Radio Man, by Pierre H. Boucheron
Sea Plane Flies by Radio Compass

SEPTEMBER, 1954

Power beyond its size—beyond its cost beyond belief!

SKYLINE IMPERIAL

the great new

with the FULL SIZE RADAR SCREEN

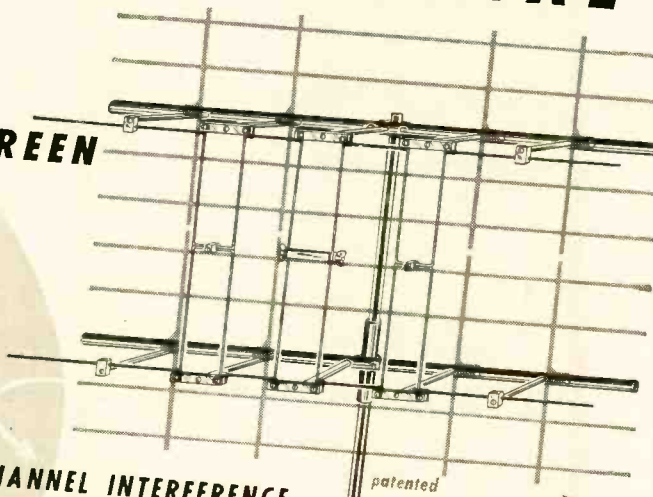

- REJECTS CO-CHANNEL INTERFERENCE
- INCREASES FRONT TO BACK RATIO
- GREATLY AMPLIFIES GAIN
- SCREENS OUT GHOSTS—NOISE AND VENETIAN BLIND EFFECT!

- All aluminum—Extra heavy throughout—Weatherproof—Minimum wind resistance

Model #701-CT (2 bay with famous "Co-Trap" screen)

\$27.50 LIST!

patented
QUICK RIG TIME—FOLDOUT DESIGN—ALL ASSEMBLED—JUST UNFOLD—TIGHTEN

SKYLINE MFG. CO., 1652 Rockwell Ave., Cleveland 14, Ohio

NOW! HIGH FIDELITY Excellence in a TWIN FURNITURE Masterpiece

The MASTER-TONE System



Equipment Cabinet has Fold-Away Door (illustrated).



Shipped completely installed F.O.B. New York. Wt. 160 lbs. Same System, Model 400, Provincial Style, Mahogany or Fruitwood \$499.50 Net

An outstanding performance-proven complete radio-phonograph high fidelity system in a beautiful compact and separable twin-cabinet ensemble—luxury-crafted of rich woods, exquisitely styled, hand-rubbed to a mirror finish . . . to inspire the ear and the eye. Equipment Cabinet contains: Bogen R-300 FM/AM Tuner and D010 Power Amplifier, Collaro 3/532 3-Speed Automatic Intermix Changer, GE Reluctance Cart-ridge. Speaker Cabinet contains University 6201 12" Coaxial 2-Way Speaker System. Each Cabinet approximately 30" H x 24" W x 17" D.

Model 300
Modern, Mahogany
\$478.50
Net

Dealer Inquiries Invited. Write for Catalog CM-8

MASTER-TONE ELECTRONICS

47 W. 63 St., New York 23, N. Y.

**"LIKE MOST HAMS
I STARTED WITH
HALLICRAFTERS"**



says
W9JZN, Hibbard E. Bannard, Trustee of
North Suburban Radio Club—W9AP

"I started on the air with a Hallicrafters Sky Buddy. I still have it and it functions well. Later I got a Hallicrafters S-40 and it really performed for me. I don't think you can beat any Hallicrafters equipment at the price. I'm certainly impressed with the many features of the SX-88, such as the main tuning and band spread locking device and the built in crystal calibrator."

*Used by 33 governments,
sold in 89 countries.*

hallicrafters

CHICAGO 24, ILLINOIS

TRY THIS ONE

CROSSOVER NETWORK

The diagram shows a simple method of isolating an 8-ohm woofer and tweeter without chokes when the output transformer has 8- and 16-ohm taps. The tweeter connects to the common and 8-ohm taps through an 8- μ f capacitor. The woofer and an 8- μ f capacitor are paralleled between the 8-

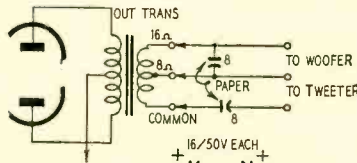

OPTIONAL CONNECTION USING ELECTROLYTICS

and 16-ohm taps as shown. Paper capacitors are recommended but you can replace each 8- μ f unit with a pair of 16- μ f electrolytics connected back-to-back.

The crossover point will be about 2,500 cycles with this arrangement.—*John Carlson.*

IMPROVISED SCREWDRIVER

Ever have a tough time trying to get the cover off the back of an auto radio in a tight place? Did you skin your knuckles trying to get a small wrench in the tight place to get the self-tapping screws out of the cabinet? You could have saved those knuckles if you had used a dime. A dime fits in the slot of most of the screws in the newer car radios and is easier to get into many tight places than even a short-handled screwdriver. — *B. W. Welz*

INSTALLING CABLE CONNECTORS

When terminating shielded cables with connectors that have cable clamps, it is desirable to connect the braided shield to the connector shell. This is usually done by removing the outer insulation and tightening the clamp over the braid. This method weakens the cable by eliminating the outer insulation at the point where it enters the connector. The insulation provides a large part of the cable's resistance to bending so its removal may allow the conductors to be damaged by excessive flexing almost bound to occur at the connector.

Weakening of the cable at the connector can be avoided by folding the shield braid back over the outer insulation and then clamping to it. In this way the original cable strength is retained while a good electrical contact is made between the shield and connector shell. —*Charles Erwin Cohn*

A HINT FOR BATTERY SETS

Before installing fresh batteries in portable radios, we wrap them in aluminum foil to protect the set from damage should the batteries corrode or become leaky.

Make sure that the foil doesn't short-circuit any connections.—*Harry J. Miller*

GREAT SAVINGS | Fall Specials

TV PICTURE TUBES ONE YEAR GUARANTEE

10BP4 .. \$10.95	17BP4 .. \$16.95
12LP4 .. 11.95	17CP4 .. 17.95
12LP4A .. 12.95	17GP4 .. 18.95
12QP4 .. 12.95	17HP4 .. 18.95
12JP4 .. 12.95	19AP4 .. 19.95
14BP4 .. 13.95	19BP4 .. 18.95
16RP4 .. 15.95	19DP4 .. 18.95
16AP4 .. 16.95	20CP4 .. 19.95
16CP4 .. 16.95	21AP4 .. 22.95
16GP4 .. 16.95	21EP4 .. 21.95
16DP4 .. 15.95	21FP4 .. 22.95

All Prices With Old Tube
Add \$5.00 deposit to tube price. Deposit is fully returned upon receipt of your old tube.

630-DX TECH-MASTER CHASSIS, \$145.00
with Cascode Tuner..... now

UHF CONVERTER Mfd. by Tech-Master for 630-DX or any 630 Chassis. (Fits into well of chassis) \$32.50

TV Wire, 300 ohm, 55 mil., 100 ft. \$1.00

DEFLECTION YOKES

60° Yokes..... 69c ea.
70° Yokes..... \$1.95 ea.

New CASCODE Tuners

Complete, \$14.95
factory aligned \$19.00 ea.

FP CONDENSER with Metal Plate,

4 Section 20/150 V. 3-20/20 V. 25c ea. 10 for \$1.95

Special! VARIABLE CONDENSERS

2 gang super het 29c ea.
3 gang AM/FM 89c ea.

2 gang mini. type 89c ea.

Small single gang 98c ea.

CONTROLS

2 meg. IRC..... 39c ea.
Sw. for above. 9c ea.
25K, Type J, A.B..... 6/89c
180K Type J, A.B..... 6/89c

CRYSTAL MIKES

Removed from equipment, 69c ea.
hearing aid type 3 for \$1.89

Miniature Chokes 29c ea.
3 leads. 3K ohms hearing aid type, 4 for \$1.

WRITE FOR FREE NEW CIRCULAR. Terms: 25% dep. with order, bal. C.O.D. F.O.B. New York City. Prices subject to change without notice.

ROSE ELECTRONICS, Inc.

76 Vesey St., New York 7, N.Y. | CO. 7-6195

GET MORE WORK OUT OF YOUR

OSCILLOSCOPE



Here, written so you can easily understand it, is a complete guide to the handiest, most widely used test instrument of them all—the cathode ray oscilloscope!

This big book, MODERN OSCILLOSCOPES AND THEIR USES by Jacob H. Ruiter, Jr. of Allen B. DuMont Labs gets right down to brass tacks. It shows where and how to use 'scopes on all types of AM, FM and TV service work . . . and on other electronic jobs as well. No fancy theory. You quickly learn how 'scopes work and how to use them for fast, accurate servicing from troubleshooting to set realigning and everything in between. You learn how to make connections; how to adjust circuit components; how to set the controls, and how to ANALYZE PATTERNS fast and right! Practice from it 10 days . . . at our risk!



MODERN OSCILLOSCOPES AND THEIR USES

The most widely used book of its kind!

326 pages
370 pictures
Price \$6.00

Dept. RE-94, RHINEHART & CO., Inc.
232 Madison Ave., New York 16, N. Y.

Send MODERN OSCILLOSCOPES AND THEIR USES for 10-day FREE EXAMINATION. If I decide to keep book, I will then send you \$6.00 plus a few cents postage in full payment. If not, I will return book postpaid and owe you nothing.

Name _____

Address _____

City, Zone, State _____

OUTSIDE U.S.A.—Cash with order only. Price \$6.50. Money back if book is returned in 10 days.

TRY THIS ONE

USEFUL DESIGN HINT

When designing electronic equipment I always keep a set of colored pencils handy for noting corrections and changes in the diagram and chassis layout. I use the crayons in increasing order according to the RETMA color code. For example, I prepare the original drawings in black lead pencil. The first change is made in red, the second in orange, and so on. When making the final drawings I follow the colored lines having the highest value in the color code.—*Ron Alexander*

IRON-CORED I.F.'S

In permeability-tuned i.f. transformers, the bottom slug is usually held by a sheet-metal nut in the middle of the fiber terminal board. When a metal screwdriver is used to tune this slug the circuit alignment may change as the screwdriver is applied and removed from it.

The slug is ungrounded so the metal tool changes its capacitance to ground, thus upsetting the tuning. The obvious cure is to solder a short jumper from the sheet-metal nut to a convenient point.—*J. Sareda*

(An equally obvious cure is, of course, to use a non-metallic aligning tool to set the slugs.—*Editor*)

TINTED TV SCREEN

If you like the filter screen TV sets and are not ready to trade your old one in, try this idea. I have used it for some time.

Go to a garage or a company dealing in automobile glass and have them cut a piece of a tinted windshield the size of the safety glass in your set. Many times a cracked windshield may be found with enough unbroken glass in it to satisfy your needs. Sometimes you can get it for just the cost of cutting and dressing the edges. Do not destroy the original glass, some people do not like it and when the time comes to trade your set you will have either one the dealer or new purchaser wants.—*Bruce C. Vaughan, Jr.*

SPLICING SHORT LEADS

Some salvaged resistors and capacitors have leads that are so short—only about one-half inch in some cases—that they cannot be used in some applications. I use a method of splicing which enables me to lengthen the leads without bulky joints.

I use either a No. 58 wire drill or a sewing needle about .045 inch in diameter as a mandrel in a pin vise and wind a tight spring-like spiral of No. 23-26 tinned wire around it. I then cut the spring into pieces of about 8 turns each. The leads to be joined are pushed into opposite ends of the spring so their ends butt in the middle. Flowing solder over the spring connector and leads completes the joint and makes it electrically and mechanically sound.—*Charles B. Carlson*

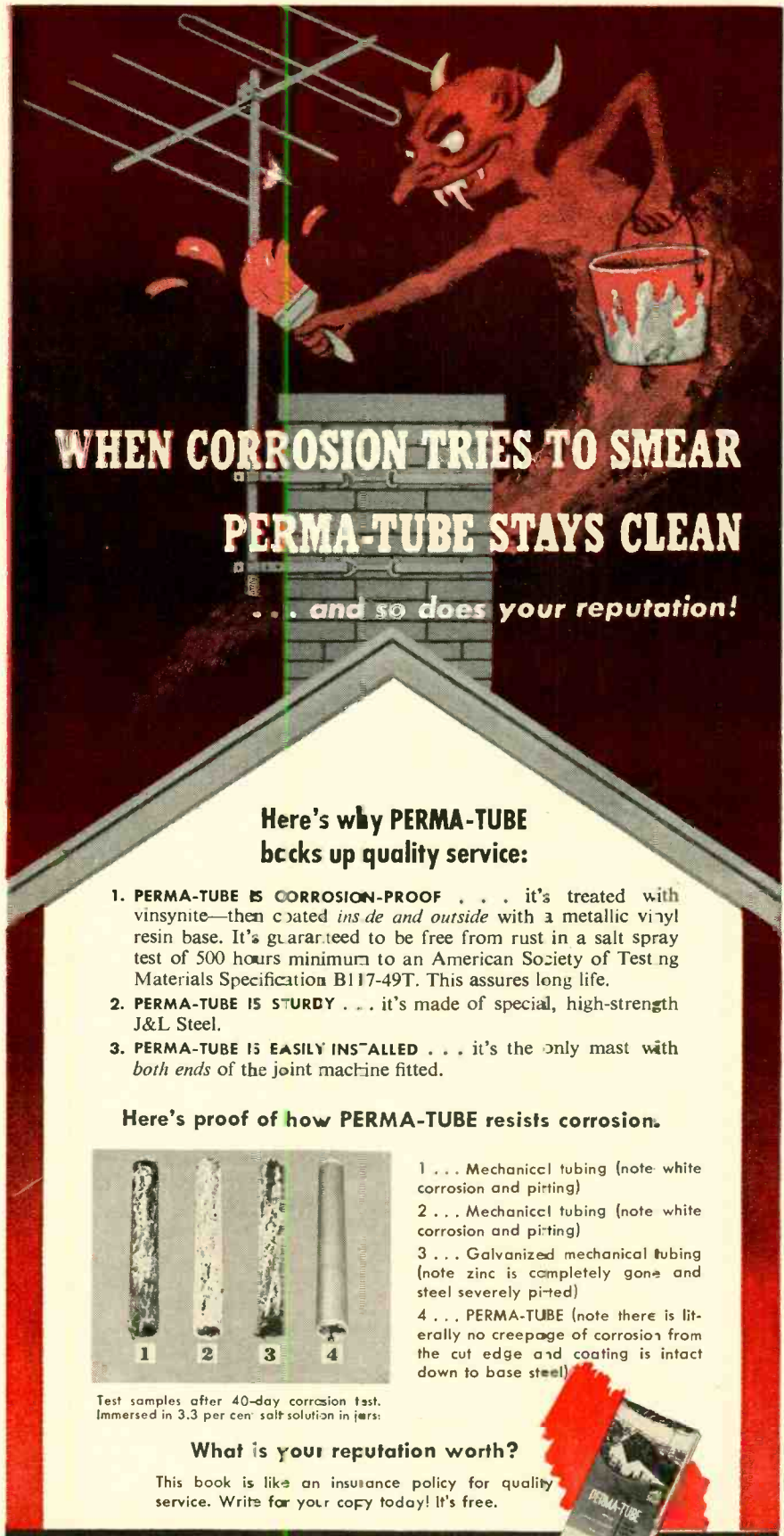

**WHEN CORROSION TRIES TO SMEAR
PERMA-TUBE STAYS CLEAN**

... and so does your reputation!

**Here's why PERMA-TUBE
backs up quality service:**

- 1. PERMA-TUBE IS CORROSION-PROOF . . .** it's treated with vinsynite—then coated *ins de and outside* with a metallic vinyl resin base. It's guaranteed to be free from rust in a salt spray test of 500 hours minimum to an American Society of Testing Materials Specification B117-49T. This assures long life.
- 2. PERMA-TUBE IS STURDY . . .** it's made of special, high-strength J&L Steel.
- 3. PERMA-TUBE IS EASILY INSTALLED . . .** it's the only mast with *both ends* of the joint machine fitted.

Here's proof of how PERMA-TUBE resists corrosion.



- 1 . . . Mechanical tubing (note white corrosion and pitting)
- 2 . . . Mechanical tubing (note white corrosion and pitting)
- 3 . . . Galvanized mechanical tubing (note zinc is completely gone and steel severely pitted)
- 4 . . . PERMA-TUBE (note there is literally no creepage of corrosion from the cut edge and coating is intact down to base steel)

Test samples after 40-day corrosion test. Immersed in 3.3 per cent salt solution in jars:

What is your reputation worth?

This book is like an insurance policy for quality service. Write for your copy today! It's free.



**J&L
STEEL**

Jones & Laughlin Steel Corporation
Dept. 496, 3 Gateway Center, Pittsburgh 30, Pa.

Please forward a copy of your "PERMA-TUBE" booklet.

Name _____
Company _____
Address _____

IT'S A
CRIME
TO OWN A
hallicrafters



A crime punishable by death behind the Iron Curtain yet there are **HALLICRAFTERS** owners there using receivers left by the Allied armies—who risk everything to maintain contact with freedom and truth.

Hidden in cellars, **HALLICRAFTERS** receivers dependably perform their part against the complete blotting out of information and truth.

Used by 33 governments,
sold in 89 countries.

hallicrafters

CHICAGO 24, ILLINOIS

TRY THIS ONE

CIRCUIT ANALYZER

The construction of some TV sets and small radios often makes it difficult to take voltage and resistance readings at the tube sockets. I solved this problem by mounting a number of wafer sockets—one for each type of tube base—on standoffs on a small wooden panel or board. Multiconductor cables connect each set of socket terminals to corresponding pins on male plugs or salvaged tube bases.

The analyzer test panel is handy when you don't want to pull a heavy TV or radio chassis or when the socket terminals of a set are not readily accessible because of parts mounted over them. Remove the tube from the stage to be checked and insert the test plug in its place. Plug the tube into the panel and take the measurements.—*Martin Bolton*

(When checking high-gain and high-frequency circuits, the long analyzer leads may cause oscillations or circuit detuning which affects the circuit performance and voltage readings.—*Editor*)

SOCKET FOR C-R TUBE

While constructing a scope I found that I did not have a socket for the C-R tube. I looked around for a temporary substitute to keep the project going until one could be ordered. I removed the contacts from a few wafer sockets, soldered appropriate leads to them and then slipped them over the base pins on the C-R tube. The resulting setup was neater than alligator clips and produced better contacts.

This arrangement worked so well that I have since used socket contacts and matching pins from old tube bases in numerous applications where simple connectors can be employed.—*Wm. B. Rasmussen*

(It is advisable to color-code the leads or tag them with the numbers of the matching pins to facilitate replacing the tube and to eliminate error. A plastic cup can be fitted over the exposed pins to avoid shock.—*Editor*)

DRY-BATTERY STORAGE

Spoilage and deterioration are problems when a large supply of dry batteries is held in stock. This can be solved by placing the batteries in a deep freezer or refrigerator that will hold the temperature below freezing. Freezing the batteries slows up chemical action and greatly increases their shelf life.—*J. Sareda*

PLUG CONNECTIONS

When preparing cables for soldering to male plugs or tube bases, it is a good idea to dip the bared wire into some soldering paste before inserting it into the prong. This makes the solder run more easily into the prong, thus simplifying the job.—*C. Cohn* **END**

**HERE'S Fast, Easy
Picture Tube
and Receiver
Testing**



**FOR ALL
MAGNETIC
BLACK-
AND-WHITE
OR
COLOR SETS**



Take the guesswork out of C-R tube testing and TV troubleshooting! New Boland & Boyce C-R Tube Tester tests all magnetic picture tubes *dynamically*—under the receiver's own power. Tells instantly whether tube or set is at fault. 600 V. d-c range extends to 30 or 60 KV by HV Probe.

Tests: Grid to cathode, heater to cathode, and grid to screen leakage; grid to cathode voltages from receiver; receiver screen and video output voltages; beam current at HV anode; grid control of beam; effect of brightness and contrast controls; aids in checking alignment and effectiveness of antenna system.

Prices include cabled leads and instruction manual. **KIT—\$29.95. FACTORY WIRED & TESTED—\$39.95.** Sold by leading distributors.

Locates picture tube or receiver faults instantly

Builds customer satisfaction . . . shows quality of each element directly on GOOD-7-BAD scale

factory wired or easy-to-build kit form

Send today for brochure describing complete line of B&B products.

B&B #703 Power Supply—Plugs into #701 C-R Tube Tester. Provides continuously variable d-c voltages to simulate receiver operation for out-of-set tests. Operates from 115 volt a-c source. **KIT—\$9.95. FACTORY WIRED & TESTED—\$12.95.**

B&B #702 Universal HV Probe—Extends range of any VTVM, multimeter, or voltmeter having sensitivity of 10,000 ohms-per-volt or more. Supplied with complete set of plug-in precision resistors and instructions to accurately match any meter . . . any range—30KV, 60KV, and many others. Save money. Use this one probe with several instruments. Ideal for B&B #701 C-R Tester.



BOLAND & BOYCE, Inc.

Dept. RE-94, 236 Washington Avenue
Belleville 9, N. J.

MAIL TODAY. LEARN RADIO AT HOME WITH THE PROGRESSIVE RADIO "EDU-KIT"

BUILD 15 RADIOS

ONLY

AT HOME \$19.95

With the New Improved 1955

Progressive Radio "EDU-KIT"

NOW INCLUDES
HIGH FIDELITY,
SIGNAL TRACER, and
CODE OSCILLATOR

- ATTRACTIVELY GIFT PACKED
- FREE SOLDERING IRON
- NO ADDITIONAL PARTS NEEDED
- EXCELLENT BACKGROUND FOR TV
- 10 DAY MONEY-BACK GUARANTEE
- SCHOOL INQUIRIES INVITED
- ABSOLUTELY NO KNOWLEDGE OF RADIO NECESSARY



WHAT THE PROGRESSIVE RADIO "EDU-KIT" OFFERS YOU

The Progressive Radio "Edu-Kit" offers you a home study course at a rock bottom price. Our Kit is designed to train Radio Technicians, with the basic facts of Radio Theory and Construction Practice expressed simply and clearly. You will gain a knowledge of basic Radio Principles involved in Radio Reception, Radio Transmission and Audio Amplification.

You will learn how to identify Radio Symbols and Diagrams; how to build radios, using regular radio circuit schematics; how to mount various radio parts; how to wire and solder in a professional manner. You will learn how to operate Receivers, Transmitters, and Audio Amplifiers. You will learn how to service and trouble-shoot radios. You will learn code. You will receive training for F.C.C. license.

In brief, you will receive a practical basic education in Radio, worth many times the small price you pay.

THE KIT FOR EVERYONE

The Progressive Radio "Edu-Kit" was specifically prepared for any person who has a desire to learn Radio. The Kit has been used successfully by young and old in all parts of the world. It is not necessary that you have even the slightest background in science or radio.

The Progressive Radio "Edu-Kit" is used by many Radio Schools and Clubs in this country and abroad. It is used for training and rehabilitation of Armed Forces Personnel and Veterans throughout the world.

The Progressive Radio "Edu-Kit" requires no instructor. All instructions are included. All parts are individually boxed, and identified by name, photograph and diagram. Every step involved in building these sets is carefully explained. You cannot make a mistake.

PROGRESSIVE TEACHING METHOD

The Progressive Radio "Edu-Kit" comes complete with instructions. These instructions are arranged in a clear, simple and progressive manner. The theory of Radio Transmission, Radio Reception, Audio Amplification and servicing by Signal Tracing is clearly explained. Every part is identified by photograph and diagram. You will learn the function and theory of every part used.

The Progressive Radio "Edu-Kit" uses the principle of "Learn by Doing". Therefore you will build radios, perform jobs, and conduct experiments to illustrate the principles which you learn. These radios are designed in a modern manner, according to the best principles of present-day educational practice. You begin by building a simple radio. The next set that you build is slightly more advanced. Gradually, in a progressive manner, you will find yourself constructing still more advanced multi-tube radio sets, and doing work like a professional Radio Technician. Altogether you will build fifteen radios, including Receivers, Transmitters, Amplifiers, Code Oscillator and Signal Tracer. These sets operate on 105-125 V. AC/DC. An Adaptor for 210-250 V. AC/DC operation is available.

THE PROGRESSIVE RADIO "EDU-KIT" IS COMPLETE

You will receive every part necessary to build 15 different radio sets. Our kits contain tubes, tube sockets, chassis, variable condensers, electrolytic condensers, mica condensers, paper condensers, resistors, line cords, selenium rectifiers, tie strips, coils, hardware, etc.

Every part that you need is included. These parts are individually packaged, so that you can easily identify every item. A soldering iron is included, as well as an Electrical and Radio Tester. Complete, easy-to-follow instructions are provided. In addition, the "Edu-Kit" now contains lessons for servicing with the Progressive Signal Tracer, F.C.C. instructions, quizzes, high fidelity instructions. The "Edu-Kit" is a complete radio course, down to the smallest detail.

TROUBLE-SHOOTING LESSONS

Trouble-shooting and servicing are included. You will be taught to recognize and repair troubles. You will build and learn to operate a professional Signal Tracer. You receive an Electrical and Radio Tester, and learn to use it for radio repairs. While you are learning in this practical way, you will be able to do many a repair job for your neighbors and friends, and charge fees which will far exceed the cost of the "Edu-Kit". Here is your opportunity to learn radio quickly and easily, and have others pay for it. Our Consultation Service will help you with any technical problems which you may have.

FREE EXTRAS

- ELECTRICAL & RADIO TESTER ● ELECTRIC SOLDERING IRON
 - TV BOOK ● RADIO TROUBLE-SHOOTING GUIDE ● CONSULTATION SERVICE ● QUIZZES ● F.C.C. TRAINING
- Progressive "Edu-Kits" Inc., 497 Union Ave., Dept. RE-96, Brooklyn 11, N.Y.

MAIL TODAY—Order shipped same day received.

10-Day Money-Back Guarantee. Include ALL FREE EXTRAS

- Send "Edu-Kit" Postpaid. I enclose full payment of \$19.95 (U.S.A. only).
- Send "Edu-Kit" Postpaid. I enclose full payment of \$20.95 (Outside U.S.A.).
- 210-250 V. Adapter for "Edu-Kit"—\$2.50.
- Send "Edu-Kit" C.O.D. I will pay \$19.95 plus postage (U.S.A. only).
- I wish additional information describing "Edu-Kit". No Obligation.
- Send me FREE Radio-TV Servicing Literature. No Obligation.

Name.....
Address.....

PROGRESSIVE "EDU-KITS" INC.

497 UNION AVE., Dept. RE-96, Brooklyn 11, N. Y.

NEW DEVICES

NEW ANTENNA

Walsco Electronics Corp., 3602 Crenshaw Blvd., Los Angeles, Calif., has introduced their new low-price *Scotty* antenna which is designed for metropolitan and suburban areas, and is capable of producing a strong signal 20 to 30 miles from the transmitter.



It is not a fringe antenna, but can be readily stacked for semi-fringe reception. The antenna has an unbreakable polystyrene insulator with outstanding electric properties. This insulator is silicone-treated to prevent the formation of dust, soot, moisture, etc.

TUBE TESTER

Radio City Products Co., Inc., Easton, Pa., has introduced a new portable tube tester, model 327P, which contains a large 4½-inch rectangular meter. It is compact in size and weighs only 9½ pounds, making it con-

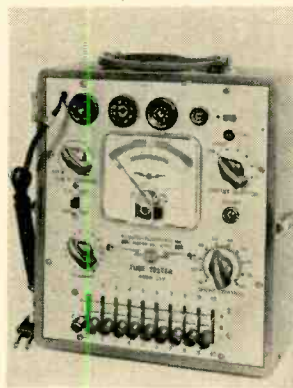

venient to take out on the job or to use in the shop or store.

Cathode-ray picture tubes, including color picture tubes, can be tested with adapter cables that are available, and can be housed in the cover of the tester. Rather than the conventional roller chart, a tab index tube chart gives quick reference. This permits immediate setup in the tube chart for new tube test data as the tubes are brought out.

MIKE AND STAND

Turner Co., Cedar Rapids, Iowa, has announced that the 50D *Aristocrat* microphone is now available in a satin black finish with a matching desk stand for TV use.

The TV version is called the 50D-TP. The stand has a built-in shock mount to minimize dis-

turbance from vibration, jars, and knocks. The microphone mounting is designed for fast conversion from desk to hand or floor stand use.



It is essentially nondirectional in operation and has an ultra-wide range. The response is listed as 50 to 15,000 c.p.s.

An advanced circuit design with a high output dynamic generator requires no closely associated auxiliary equipment. The low-impedance model with a 4-pin Cannon connector may be used for either 50-ohm or 200-ohm output. A high-impedance model also is available.

OSCILLOSCOPE

Sylvania Electric Products, Inc., Great Arrow Drive, Buffalo, N.Y., has announced the type 404 wide-band all-purpose oscilloscope for designing and servicing television receivers. It utilizes a seven-inch cathode-ray tube for extra large patterns.



Sensitivities are: vertical—10 millivolts per inch; horizontal—150 millivolts per inch. The vertical plates are 24 volts per inch, and the horizontal plates are 26 volts per inch. The input impedances are: vertical amplifiers—5 meg. 26 µf; horizontal amplifiers—5 meg., 31 µf; vertical and horizontal plates (direct)—4.7 meg. 16 µf; accelerating potential—2,200 volts. Sweep rates are from 25 cycles to 50 kilocycles.

SPEAKER CABINETS

Jensen Manufacturing Co., 329 S. Wood St., Chicago, Ill., has introduced two new back-loading cabinets for 12-inch and 15-inch speakers. They can be used with coaxial or Triaxial speakers, mid-channel and high-frequency units, and woofers. All units are mounted from the rear of the cabinet and are concealed behind the acoustic-type plastic grill cloth. The pre-cut openings in the front baffle are blocked by an adapter baffle. The cabinets are designed to fit into a corner or they may be placed against a

new --- model 114-093

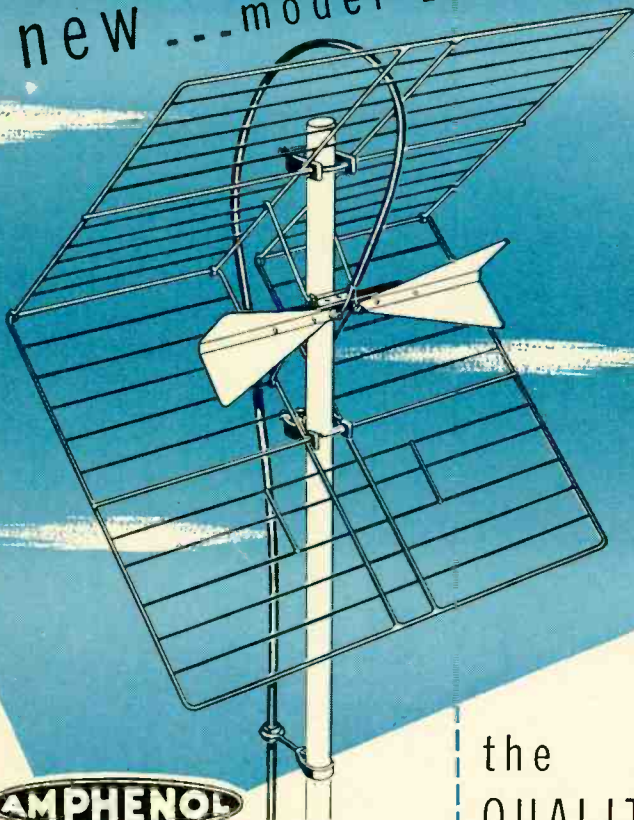

AMPHENOL

LIGHTWEIGHT UHF CORNER REFLECTOR

Here is the fastest-to-install antenna that you will ever handle! The new LIGHTWEIGHT UHF Corner Reflector is ingeniously designed so that when the two reflector screens are opened like a book the element snaps out automatically. The antenna is then easily attached to the mast (with two sturdy mast clamps) and installed in a matter of seconds!

The electrical characteristics of the new LIGHTWEIGHT Corner Reflector are excellent. The gain rises from 8 db to 12½ db across the UHF channels, more than enough gain to provide sharp, clear pictures in weak signal areas. Directivity, as on all AMPHENOL antennas, is exceptionally fine. There is one strong forward lobe that makes antenna/station alignment easy for the installer.

With the addition of the LIGHTWEIGHT Corner Reflector to the AMPHENOL line of quality antennas, AMPHENOL now offers every installer a quality choice of UHF Corner Reflectors--the new 114-093 LIGHTWEIGHT and the "king-size" model 114-058 Corner Reflector, previously in production.

AMERICAN PHENOLIC CORPORATION
chicago 50, illinois

the
QUALITY
antenna
line

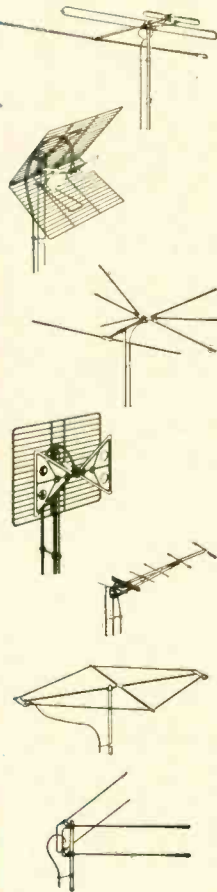

AMPHENOL

in canada:
AMPHENOL CANADA LTD.

NEW DEVICES

side wall. Low-frequency radiation is augmented by acoustic passages opening into the sides of the cabinet. Model BL-250 is for 12-inch speakers, and model BL-121 is for 15-inch speakers.

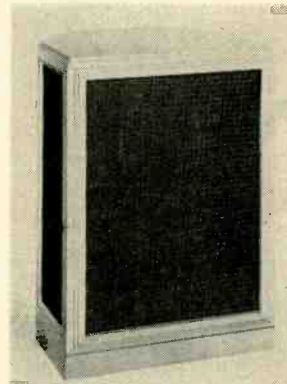

INDOOR ANTENNA

Peerless Products Industries, 812 N. Pulaski Rd., Chicago 51, Ill., has announced its new *Diron Golden Wand* TV indoor antenna, model DV11G. It has been pretuned to receive all v.h.f. channels and FM. The broad-band characteristics of

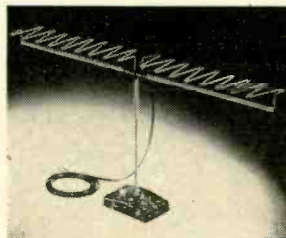

the *Diron* permit black and white and color transmission. Directly coupled elements provide high gain.

Twelve feet of 300-ohm twin lead permits location behind a bookcase or even in a closet. It is available in gold and in black.

SOLDERING GUN

Wen Products, Inc., 5808 Northwest Highway, Chicago 31, Ill., has announced the new *Quick-Hot* soldering gun, model 199. It weighs only 1½ pounds. It is ready to work 2½ seconds after power is applied. It is designed for extra-long reach. Its balance makes it handy to use without tiring the user.

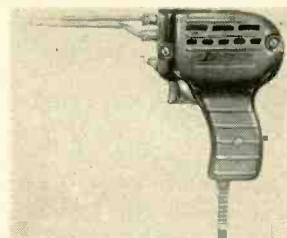

PANEL INSTRUMENTS

Simpson Electric Co., 5200 W. Kinzie St., Chicago 44, Ill., has announced an addition to its panel instrument line. These sealed ruggedized panel meters will be made with d.c. ranges showing any practical scale from 300 µa to 800 ma. The

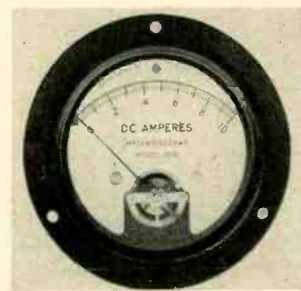

meters will be available in two sizes--2½ inches and 3½ inches.

REPLACEMENT TRANSFORMERS

Merit Coil & Transformer Corp., 4427 N. Clark St., Chicago 40, Ill., has put on the market three new horizontal output transformers which are designed as exact replacements for similar Admiral units. The

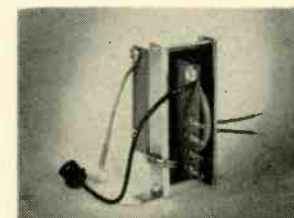

models HVO-22, HVO-23, and HVO-24 all have mounting brackets, mounting centers, terminal boards, and terminal locations exactly comparable to the Admiral television transformers they are designed to replace.

SOLDER DISPENSER

CBS-Hytron, Danvers, Mass., has announced the development of a solder dispenser and refills for it. It is a one-hand tool and does away with haywire coils of solder. The operator's thumb



on the knurled wheel of the solder dispenser feeds solder and retracts it when the job is done. It holds 72 inches of solder. The dispenser is light and pencil-like with a pocket-clip; it comes ready to use--loaded with 20 refills.

REPLACEMENT FLYBACKS

Stancor Division of the Chicago Standard Transformer Corp., Addison & Elston, Chicago 18, Ill., has announced the addition of exact replacement flyback transformers for Motorola and Muntz, both physically and electrically, which do not require chassis or circuit alterations.

Stancor flyback A-8239 is an

RADIO-ELECTRONICS

exact replacement for Motorola parts Nos. 24K792753 and 24K-701099. A-8239 has application in over 100 Motorola models and chassis. A-8240 is an exact replacement for the Muntz part No. TO-0036.

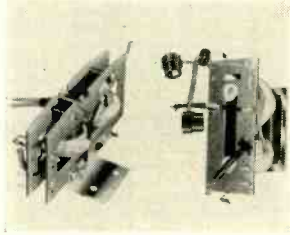

NEW TESTER

Triplet Electrical Instrument Co., Bluffton, Ohio, has introduced a new tester, model 631,

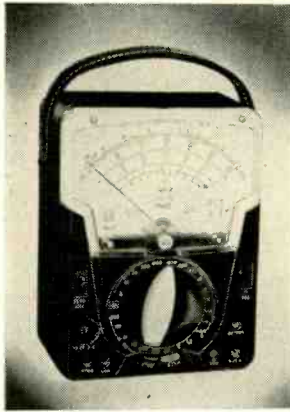

that combines a volt-ohm milliammeter and a vacuum-tube volt-meter in a single unit.

Its characteristics include: 34 ranges, v.o.m. 10 a.c.-d.c. volts; six direct current; resistances from 0.1 ohm to 150 megohms; decibel and output readings. V.t.v.m.: four, including 1.2-volt range for grid voltage and accurate discriminator alignment.

Sensitivity: V.o.m. 20,000 ohms per volt on d.c.; 500 ohms per volt on a.c.; V.t.v.m.: 11 megohms.

One switch on the unit selects all ranges and minimizes chance of incorrect settings and burnouts. The knob is large and flush with the panel.

The model 631 has a large 5½-inch meter with an exceptionally legible scale.

NEW LOUDSPEAKERS

RCA Victor Division, Radio Corporation of America, Harrison, N. J., has announced the availability of two new loudspeakers which feature larger-than-usual Alnico V magnets.

The speakers are a 6½-inch permanent-magnet type 220S1, for replacement service in table model radio and television receivers, and in centralized sound systems; and a 6 x 9-inch permanent-magnet type 218S1, for use in automobile radios and home music systems.

The 220S1 type incorporates a 2.15-ounce Alnico V magnet, a 3.2-ohm voice coil, and a

special universal flange for mounting a wide range of transformer sizes.

The 218S1 speaker has a 3.2-ohm voice coil and an Alnico V magnet weighing only 2.9 ounces; yet it has the performance capabilities of a speaker designed with a 3.16-ounce magnet.

AUTO AERIALS

Brach Manufacturing Corp., 20 Central Ave., Newark 3, N. J., is delivering to the replacement market two new universal auto aerials, models 473, *Speed-mount*, and model 501, the *Fendermount*.

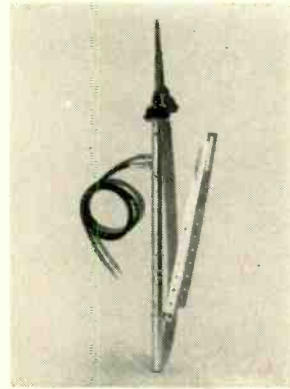

Each unit has a three-section triple chrome-plated brass mast, automatic ground connection, and an adjustable (0-32°) insulator.

INVERTER

American Television & Radio Co., 300 E. 4th Street, St. Paul, Minn., has announced an ATR inverter which can be used in any auto for operating standard tape recorders, wire recorders, or any other type of dictation machine.



The ATR tape recorder inverter operates from the 6- or 12-volt d.c. automotive storage-battery system and provides 110 volts a.c. household electricity for operating the recorder.

The inverter is available with mounting brackets for under-dash or trunk mounting. A remote-control unit is available for use with inverter, when inverter is mounted in trunk compartment.

8-BOW ANTENNA

JFD Manufacturing Co., Inc., 6101 16th Avenue, Brooklyn 4, N. Y., has announced a new 8-bow antenna with a calibrator. This precision calibrator

Just Out

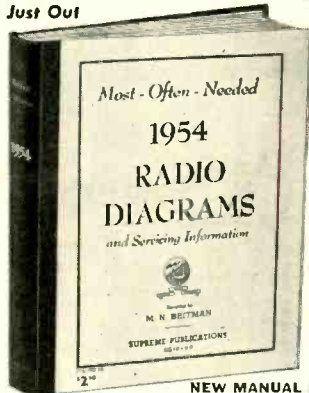

NEW MANUAL
Be prepared to repair quickly all new 1954 radio receivers. In this big single volume you have easy-to-use, extra large schematics, needed alignment data, replacement parts lists, voltage values, and information on stage gain, location of trimmers, and dial stringings, for almost every 1954 radio. Includes auto radios, portables, changers, and all types of home sets. Giant size, 8½x11"; manual style, sturdy binding. Price, only... **\$2.50**

New Supreme 1954 Radio Manual

Now you can benefit and save money with Supreme amazing scoop of 1954. This one giant volume has all the service data you need on all recent radio sets. A full year of models of all popular makes, home and auto sets, portable radios, combinations, changers, all included. The full price for this mammoth 1954 manual is only \$2.50, nothing else to buy for a whole year. Other Supreme radio service volumes for previous years (mostly at \$2) are described below. Separate TV manuals listed at right.

SUPREME RADIO MANUALS FOR PREVIOUS YEARS

Use Supreme manuals to repair all radios faster, easier; save time and make more money. Here is your lowest-priced service data. Covers all years, from 1926-38 to 1954 models, in 14 volumes. Used by 163,000 shrewd servicemen. Most volumes only \$2 each, see coupon. Average volume 192 large pages, 8½x11 inches. Quality printing, manual-style binding. Amazing values. Be wise, use these manuals to get all needed diagrams, parts lists, alignment facts, and service hints, at the smallest cost. Send no-risk coupon.

SUPREME TELEVISION SERIES

Here is your complete source of TV service data. These manuals at only \$3, \$2, and \$1.50 each are amazing bargains and defy competition. Each manual covers a whole year of models, using original, factory material. Include giant double-spread circuits and blueprints, alignment procedure, voltage charts, test patterns, wave forms, factory revisions, and helpful service hints. Select volumes from list below and send no-risk coupon.

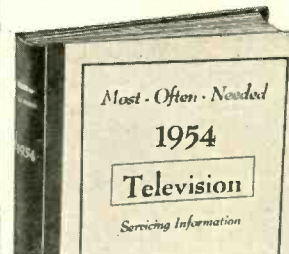

- 1954 TV Manual. New, giant volume of TV factory data. Complete, only \$3
- 1953 TV Manual, \$3
- 1952 TV Manual, \$3
- 1951 TV Manual, \$3
- 1950 TV Manual, \$3
- 1949 TV Manual, \$3
- 1948 TV Manual, \$3
- 1947 FM & TV, \$2
- UHF Manual, \$1.50

NO-RISK TRIAL ORDER COUPON

SUPREME PUBLICATIONS, 1760 Balsam Rd., Highland Park, ILL.

Radio Diagram Manuals

- 1954 Radio Manual, \$2.50
 - 1953 Diagrams
 - 1952 Radio
 - 1951 Diagrams
 - 1950 Manual
 - 1949 Radio
 - 1948
 - 1947
 - 1946
 - 1942
 - 1941
 - 1940
 - 1939
 - 1926-1938 Manual, \$2.50
 - Master INDEX only 25¢
- EACH \$2.50**
PRICED AT ONLY \$2 EACH

Rush today Radio manuals checked at left and TV manuals below. Satisfaction guaranteed.

- Supreme 1954 Television Servicing Manual, only \$3.
- 1953 TV Manual, \$3.
- 1952 Television Manual, \$3.
- 1950 Television Manual, \$3.
- 1948 TV, \$3.
- Television Servicing Course, complete, only \$3.
- UHF Manual, \$1.50
- 1951 TV, \$3.
- 1949 TV, \$3.
- 1947 TV & FM, only \$2.

I am enclosing \$..... Send postpaid.
 Send C.O.D. I am enclosing \$..... deposit.

Name:
Address:

TELEVISION SERVICING COURSE
Let this new course help you in TV servicing. Amazing bargain complete, only \$3, full price for all lessons. Giant in size, mammoth in scope, topics just like a \$200.00 correspondence course. Lessons on picture faults, circuits, adjustments, short-cuts, UHF, alignment hints, antenna problems, trouble-shooting, test equipment, picture analysis. Special, only **\$3**

Supreme Publications
Sold by All Leading Parts Jobbers

New EMC instruments increase your testing ability

EMC model 107 VTVM



Directly measures capacity, resistance and complex waveforms peak to peak..

This new multi-function meter contains an exclusive combination of features never before offered for less than \$100. Expanded scale meter cannot burn out... measures capacity from 50 MMFD to 5000 MFD... inductance from 1.4 henries to 140,000 henries in 4 ranges... uses an electronic balanced push-pull circuit and peak to peak rectification... 1% multipliers for voltage capacity and resistance measurements... has zero center position for FM discriminator alignment.

Measures directly in 6 ranges—all peak to peak voltages of complex waveforms... between .2 volt and 2800 volts—RMS values of sine wave voltages... between .1 volt and 1000 volts—capacity of condensers between 50 MMFD to 5000 MFD—resistance from .2 ohms to 1000 megohms.

model 107 **\$4890**
complete with leads

kit form..... **\$34.50**

ACCESSORY PROBES AVAILABLE

CONTI

EMC model 206 mutual conductance tube tester

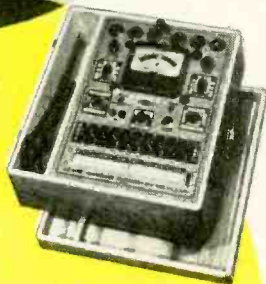

Extremely accurate results with new ease of operation.

Lever-type switches assure complete and extremely accurate testing

of all present and future tube types regardless of element location. Mutual conductance checked on calibrated micromho scale and "reject-good" scale... tubes checked for gas content... 5 element tubes checked as pentodes... all loctal, octal, miniature and subminiature tubes checked for both shorts and opens... sufficient plate current to check emission and mutual conductance... tests all tubes from .75 volts to 117 filament volts... checks for radio frequency and other noise... tests all cold cathode, magic eye, voltage regulators and ballast resistors... plus individual sections of multipurpose tubes... individual tube sockets eliminate prong damage... instrument fuse replaced from panel front... handy built-in roll chart makes accurate testing easy.

model 206 **\$8350**
(hand rubbed oak carrying case)

MODEL 206C (sloping counter case) **\$79.50**

MODEL CTA (picture tube adaptor) **\$9.95**

SAVE MORE... SERVICE BETTER... with EMC precision test equipment.

New EMC catalog of precision test equipment available... write Dept. RE-9 today!

EMC ELECTRONIC MEASUREMENTS CORPORATION
280 LAFAYETTE STREET NEW YORK 12, N. Y.
EXPORT DEPT.—136 LIBERTY ST. N. Y. 6, N. Y.

NEW DEVICES

is a custom-built graduated slide. It connects the bow to the screen element, and is easy to peak for any u.h.f. channel or group of channels. It adjusts the spacing between bows and grids. This provides high signal-to-noise ratio.

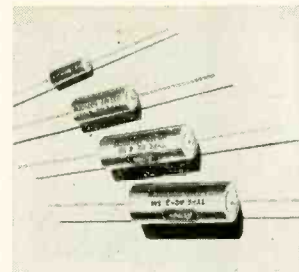

tion of Astron Meteor line of capacitors. X-250 provides high capacitance stability, low power factor, low resonance loss, and high test voltage. The capacitance versus temperature curve of Meteor capacitors is practically flat from -40°C to $+125^{\circ}\text{C}$, and at -65°C the capacitance decrease with temperature is less than 5%.

Type AQ and TQ capacitors are hermetically sealed metal-tubular subminiature units designed for operation over a wide temperature range of -65°C to $+125^{\circ}\text{C}$ without derating. They are available also in a variety of MIL-C-25A case styles and higher capacitance values for broader application in electronic designs.

NEW SYLUS

Pickering & Company, Inc., Oceanside, Long Island, N. Y., announces that its model 260 turnover magnetic pickup cartridge is now available with a diamond stylus for long-playing recordings and a sapphire stylus for standard 78 record-

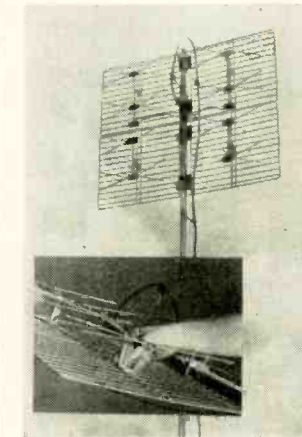

In addition to the adjustable dipole mounting bracket, there is side-by-side stacking of two 4-bay bows. The antenna has a sharp horizontal pattern which indicates a narrow beam width, and side lobes are negligible. The beam pattern of the major lobe width is 15° at the half power points, and average back rejection is 18 db.

DUAL PURPOSE PROBE

Scala Radio Co., 2814—19th St., San Francisco, Calif., has announced a dual-purpose probe which can be used as both a direct probe and an alignment probe.

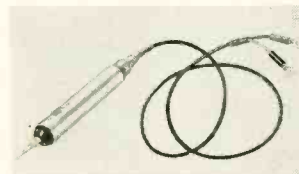

A switch governs use. As a direct probe, the BZ-5 is designed for general troubleshooting. Shielding guards against pickup of stray fields near the chassis, with a minimum of circuit loading.

In visual alignment work, where a filter characteristic is required and the direct probe should not be used, a flip of the switch converts the BZ-5 into a resistive isolating probe. Thus used it provides the optimum filter characteristics essential for visual alignment. The arrangement is basically that of a low-pass filter which sharpens up the alignment markers and also cleans up noisy response curves.

The new probe will work efficiently with any oscilloscope. It is furnished complete with calibrated low-capacitance coaxial cable which can be used with all Scala probes.

X-250

Astron Corp., 255 Grant Ave., East Newark, N. J., has developed impregnant X-250 which is being used in the construc-



ings. The diamond stylus is of .001 inch radius for long-playing records and the sapphire stylus is of .0027 inch radius for standard groove 78-r.p.m records.

Except for the sapphire stylus, this unit is identical in all respects to the Pickering model 260 double-diamond turnover pickup which features low over-all distortion, high compliance, low-moving mass, minimum tracking force and high output.

NEW PROJECTOR

Atlas Sound Corp., 1449 39th St., Brooklyn 18, N. Y., has announced a new wide-angle, all-purpose projector called the Cobra-projector, model CJ-30. It features a polyester fiber-glass projector, Alnico-V-Plus magnetic assembly, 100% phenolic diaphragm and voice coil assembly, and universal bracket.

It is excellent for applications such as paging and talk-back, intercommunication, and marine and industrial installations. It reproduces with a crisp, penetrating characteristic giving coverage of wide areas and under difficult conditions such as high noise, adverse winds, etc.

SPEAKER SYSTEM

Permoflux Corp., 4900 W. Grand Ave., Chicago 39, Ill., has introduced its new *Largo* speaker system which utilizes the new Permoflux model 8V81 *Super Royal* speaker (8-inch) and 32KTR super-tweeter model in an enclosure.

The compact speaker system's enclosure is a horn-loaded non-resonant baffle with the horn loading of the speaker back-wave taking place in the cabinet base. Baffle and speaker characteristics provide undistorted reproduction of all frequencies from 35 cycles to 16,000 cycles.

The *Largo* speaker system features a high-frequency balance control and a special connector to receive a headset extension cord for private listening and



hard-of-hearing music lovers. It is constructed of mahogany and Korina veneers. END

All specifications given on these pages are from manufacturers' data.

high, low resistance range with a 2-ohm center scale; low-voltage range provides 1.2 volts full scale, both a.c. and d.c.; an extended low d.c. current range starts at 0-160 microamperes.

Range selection with the model 120 is achieved through



a 36-range, 18-position, positive-detenting, master range selector with low resistance, silver-plated contacts.

The ranges are: 8 d.c. voltage, 0-1.2-3-12-60-300-600-1200-6000 volts; 8 a.c. voltage and output; 0-1.2-3-12-60-300-600-1200-6000; 7 current (d.c.) 0-1.2-120-600 ma, 0 to 12 amperes; 5 resistance, 0-200-2000-200,000 ohms, 0-2-20 megohms; 8 decibel, from -20 to + 77 db (0 db taken as 1 milliwatt across 600 ohms).

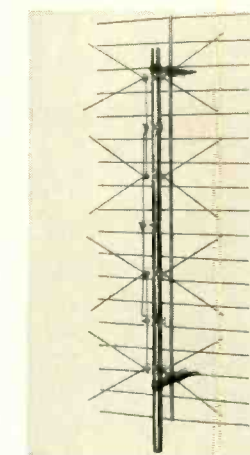

model; and UBT-4, a four-stack model especially designed for ultra-fringe areas.

The manufacturer claims high gains, excellent front-to-back ratios, and unusually good match to the standard 300-ohm line.

NEW TESTER

Precision Apparatus Co., 92-27 Horace Harding Blvd., Elmhurst, L. I., N. Y., has announced the new model 120 multirange test set which operates on 20,000 ohms per volt d.c. and 5,000 ohms per volt a.c.

It has 44 self-contained ranges which start low and go



Electrical connections can be made either to the extending plastic-covered leads or directly to the driver unit terminals. The universal mounting bracket permits adjustment in both a vertical or horizontal position without the need to change the bracket position on the wall or mounting surface.

The specifications are: input power (continuous), 15 watts; input impedance, 8 ohms; response 250 to 9,000 c.p.s.; and dispersion, 120° x 60°. Shipping weight is 6 lbs.

U.H.F. ANTENNAS

Trio Mfg. Co., Griggsville, Ill., now has an improved version of their UBT series of u.h.f. antennas. The new antennas are of the bowtie and reflector type with all elements and phasing bars constructed of hard-drawn aluminum rod for extreme rigidity, low wind resistance, and light weight. They are made in three models: UBT-1, a single bowtie with reflector; UBT-2, a two-stack

Windsor

RADIO & TV RECEIVING

TUBES

GUARANTEED ONE FULL YEAR

... FOR PEAK PERFORMANCE!

Thousands of Service Organizations and Dealers send us REPEAT orders month after month—they KNOW you can DEPEND on the WINDSOR promise of PEAK PERFORMANCE! Every tube we ship is first carefully tested in our labs, right in a radio or TV set, under actual operating conditions. Each WINDSOR tube is attractively packaged in the famous WINDSOR carton that has gained consumer acceptance throughout America.

BUY—AND SELL—WINDSOR TUBES, with CONFIDENCE!

Type	Each	Type	Each
OA2	.90	IR4	.85
OB2	.88	IR5	.62
OC3	.95	IS4	.67
IA7GT	.67	IS5	.52
IAE4	.90	IT4	.62
IB3GT	.69	IU4	.61
IHSGT	.51	IU5	.51
IJ6	.93	IV2	.45
IL4	.63	IX2A	.74
IL6	.66	2X2	1.43
ILA4	.82	3A5	.90
ILA6	.80	3LF4	.76
ILB4	.82	3Q4	.66
ILC5	.80	3Q5GT	.72
ILC6	.80	3S4	.61
ILD5	.80	3V4	.62
ILE3	.80	5R4GY	1.00
ILG5	.80	5U4G	.49
ILH4	.80	5V4G	.83
ILN5	.80	5Y3GT	.37
IN34	.90	5Y3GT	.42
IN48	.50	5Y4G	.43
IN5GT	.63	6A8GT	.68
IN64	.75	6AB4	.51

Type	Each	Type	Each	Type	Each	Type	Each	Type	Each
6AC5GT	.82	6BF6	.43	65A	.51	7A7	.58	7D7	.58
6AC7	.90	6BG6G	1.47	65A7GT	.75	7A8	1.05	7E7	.58
6AF4	1.10	6BH6	.63	6S7	.63	7AF7	.63	7F7	.92
6AG5	.59	6BJ6	.53	6SC7	.63	7AG7	.65	7W7	.99
6AH4	.68	6BK5	.76	6SD7	.55	7AH7	.65	7X6	.62
6AH6	.89	6BK7	.97	6SF5GT	.66	7AJ7	.70	7Y4	.45
6AK5	1.05	6BL7GT	.94	6SG7	.55	7B4	.54	7Z4	.50
6AL5	.44	6BN6	.98	6SH7GT	.52	7B5	.51	12A6	.60
6AN8	.95	6BQ6GT	.98	6S7GT	.52	7B6	.52	12AL5	.44
6AQ5	.51	6BQ7	.92	6SK7GT	.55	7B7	.58	12AT6	.53
6AO6	.47	6BY5G	.85	6SL7GT	.68	7C5	1.05	12AT7	.75
6AQ7	.75	6BZ7	1.09	6SN7GT	.59	7C6	.56	12AU6	.47
6AR5	.42	6C4	.41	6SQ7GT	.46	7C7	.58	12AU7	.58
6AS5	.55	6C5GT	.60	6T8	.85	7C8	.72	12AV6	.41
6ASTG	4.50	6CB6	.58	6U4GT	.75	7E6	.85	12AV7	.87
6AT6	.42	6CD6G	1.57	6U5	.65	7E7	.65	12AX4	.72
6AU5GT	.85	6CS6	.56	6U8	.86	7E8	.85	12AX7	.67
6AU6	.47	6D6	.63	6V3	1.09	7F6	.69	12AY7	2.15
6AV5	.85	6E5	.72	6V6GT	.51	7F7	.97	12AZ7	.78
6AV6	.41	6F5GT	.54	6V8	.85	7F8	.85	12B4	.66
6AX4	.72	6H6GT	.55	6W4GT	.50	7H7	.61	12BA6	.50
6BBG	.93	6J5GT	.44	6W6GT	.63	7J7	.85	12BA7	.66
6BA6	.50	6J6	.68	6X4	.37	7K7	.85	12BD6	.51
6BA7	.66	6J7	.70	6X5GT	.36	7L7	.85	12BE6	.52
6BC5	.58	6K6GT	.45	6X8	.82	7N7	.62	12BF6	.50
6BC7	.78	6K7	.70	6Y6G	.64	7Q7	.62	12BH7	.69
6BD5GT	.98	6L6G	.88	6ZY5	.60	7R7	.70	12BY7	.77
6BD6	.54	6L6GA	.88	7A4/XXL	.57				
6BE5	.51	6Q7GT	.55	7A5	.70				
6BF6	.66	6R7	.75	7A6	.57				

WINDSOR "WONDER-BEAM" 3-WAY TV ANTENNA

For Average Areas, Fringe Areas and UHF, Adjustable arms, and new electronic wonder-switch for optimum performance with any TV set!

SPECIAL PRICE \$5.69 each
Lots of Six \$34.14 (Singly \$5.95 each)

FREE! WINDSOR TUBE CADDY

Most practical service-aid ever designed for Radio & TV repairmen! Now offered FREE with every purchase of \$160.00 or accumulated purchases totaling \$160.00 within 90 days. (You get Caddy credit memo with each purchase).

- Carries approximately 125 tubes including meters and tools.
- 16 3/4" Long, 8 1/2" Wide, 1 3/4" High. Weighs only 9 lbs.
- Ruggedly constructed with heavy leatherette covering, strong plastic handle, nickel plated hardware, and reinforced with metal clamps.

WINDSOR TUBE CADDY MAY ALSO BE PURCHASED OUTRIGHT FOR \$14.95.

Note to our Latin-American Friends: "Se Habla Espanol!"



WINDSOR "BROW-LITE"

LEAVE BOTH HANDS FREE TO WORK!

World's most useful flashlight! Ideal for Radio & TV Repairmen. Uses standard penlite batteries and bulb. Won't interfere with glasses, rides above them over the brow. Complete with Batteries. \$4.95

25% Deposit with Order. All merchandise F.O.B. N.Y.C. For orders less than \$10, add \$1 handling cost. Deduct 2% if full remittance accompanies order. All merchandise subject to prior sale and price changes without notice.

Windsor ELECTRONIC TUBE CO.
2612-C NOSTRAND AVENUE, BROOKLYN 10, N. Y.

Write for Additional Tube Types and Prices. We also stock Special Purpose and Transmitting Tubes at Similar Savings! Dept. C-9.

SERVICEMEN: CASH IN 6 WAYS with the New, Improved



TV Component Tester

for the COMPLETE TESTING of

- | | |
|--------------------------------------|--------|
| 1. PICTURE TUBES, value..... | \$ 39. |
| 2. FLYBACKS & YOKES, value..... | 39. |
| 3. SELENIUM RECTIFIERS, value..... | 29. |
| 4. CONDENSERS, value..... | 39. |
| 5. CONTINUITY, value..... | 15. |
| 6. PIC. TUBE REACTIVATOR, value..... | 15. |

Total Instrumentation value.....\$176.

Yes, \$176 worth of TV
Test Equipment in one
instrument for only....

\$49.95



This great instrument performs 6 vital functions:

- PICTURE TUBE TESTER
- FLYBACK & YOKE TESTER
- SELENIUM RECTIFIER TEST.
- CONDENSER TESTER
- CONTINUITY TESTER
- PIC. TUBE REACTIVATOR

TRY IT for 10 DAYS

On Money-Back Guarantee:

10 DAY TRIAL: Try this Transvision TV COMPONENT TESTER for 10 days. Then, if you are not 100% satisfied, you may return it. Your purchase price, less 10% (our cost of handling and repacking) will be promptly refunded.

TRANSVISION, INC. • NEW ROCHELLE, N. Y.

TRANSVISION, INC., New Rochelle, N. Y. Dept. E9

() Send TV COMPONENT TESTERS @ \$49.95

() Enclosed find \$ deposit. Balance C.O.D.

() Enclosed find \$ in full.

I accept your 10 Day Trial terms.

Name _____

Address _____

City _____ State _____

My Jobber is _____

—JOBBER INQUIRIES INVITED—

RADIO-ELECTRONIC CIRCUITS POWER FOR PHOTOFLASH

For years, lightweight power supplies for electronic photoflash units have been designed and constructed by engineers and experimenters alike. Most modern photoflash tubes operate with about 900 volts between plate and cathode; earlier types require 2,000 volts or more. There are several general approaches to the design of the power pack. Some are a.c. operated with oscilloscope-type high-voltage supplies, some have storage batteries with vibrator-type supplies, while others use small 300-volt B-batteries in series to develop the required voltage for the photoflash tube.

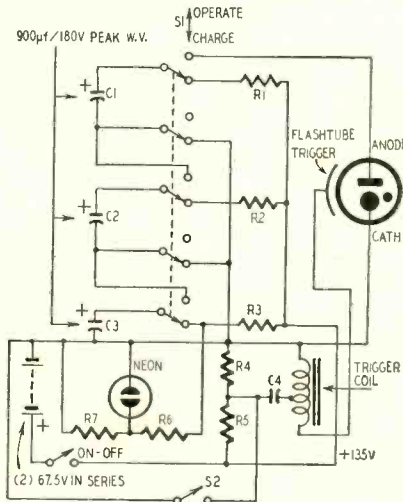

An article in *The Radio Constructor*, a British publication, describes an electronic photoflash unit using two 67.5-volt portable radio batteries in a novel arrangement to supply operating voltage for a flash tube requiring 400-450 volts.

When switch S1 is in the CHARGE position as in the diagram, C1, C2, and C3 are connected in parallel across the 135-volt battery supply so they charge through R1, R2, and R3, respectively. Throwing S1 to OPERATE connects C1, C2, and C3 in series to apply 405 volts between plate and cathode of the photoflash tube. The neon indicator lamp is across a section of a 135-volt voltage divider consisting of R3, R6, and R7. The values of R6 and R7 are proportioned so the neon lamp lights when the charge on the capacitors reaches about 110 volts. The combined values of R3, R6, and R7 should be comparatively high to minimize the load on the batteries.

The trigger coil may be a G-E type 86G41 or a model airplane spark coil. C4 is a 400-600-volt paper capacitor of about 0.25 μ f. The combined resistance of R4 and R5 should be high enough to limit the current drain to 5-8 ma. Adjust their values so the coil supplies a trigger pulse of sufficient amplitude for reliable operation.

The time-constant of R5-C4 should not be longer than the time required for C1, C2, and C3 to reach full charge.

I JUST WANT THE FACTS—LEE
NOTHING PAYS OFF LIKE THE FACTS



PERMO'S CATALOGS,
REPLACEMENT GUIDES AND SALES AIDS
HAVE ALWAYS BEEN LOADED WITH FACTS

NOW! in addition

**PERMO
PHONO NEEDLES**

WILL BE LISTED IN
SAMS' PHOTOFACTS



PERMO, INC.

CHICAGO 26

NEW EICO PROBES*

SCOPE PROBES



SCOPE DEMODULATOR PROBE
KIT \$3.75 WIRED \$5.75

LOW CAPACITY PROBE
KIT \$3.75 WIRED \$5.75

DIRECT PROBE
KIT \$2.75 WIRED \$3.95

SPECIAL All 3 Scope Probes
KIT \$9.95 WIRED \$14.95

VTVM PROBES

VTVM RF PROBES
KIT \$3.75 WIRED \$4.95

PEAK-TO-PEAK PROBES
KIT \$4.95 WIRED \$6.95



Sensational High Voltage Probe

Model HVP-2 . . . ONLY \$4.95

© 54 Extends range of VTVMs & VOMs to 30 KV
*pat. pend.



Write for FREE Catalog CP-9

ELECTRONIC INSTRUMENT CO., INC.
84 Withers Street • Brooklyn 11, N. Y.

RADIO-ELECTRONIC CIRCUITS

R1, R2, and R3 are current limiting resistors to equalize the charge on the capacitors and prevent arcing across the contacts of S1 when it is thrown to OPERATE. Consult the photoflash capacitor manufacturer's data for recommended resistor values at the specified charging voltage.

S2 is the firing switch which may be on the synchronizer solenoid or a contact on the camera shutter. S1 must be rated to handle the voltages in this circuit.

This same type of supply can be adapted so that a single 300-volt B battery can be used to supply a G-M tube or a photoflash tube requiring 900 volts.

VARIABLE BANDWIDTH

When a wide-band AM signal is tuned in on a receiver which has a narrow peaked i.f. response or a flat topped band-pass response substantially narrower than the transmitted band of frequencies, the higher modulation frequencies are greatly attenuated. The more common methods of broadening i.f. amplifier response are well known to readers of this magazine. Patent No. 2,514,443, issued to Murray G. Crosby, describes two radically new methods of

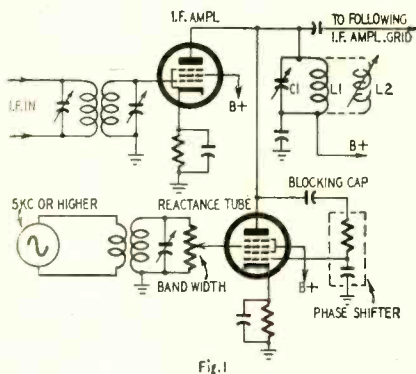
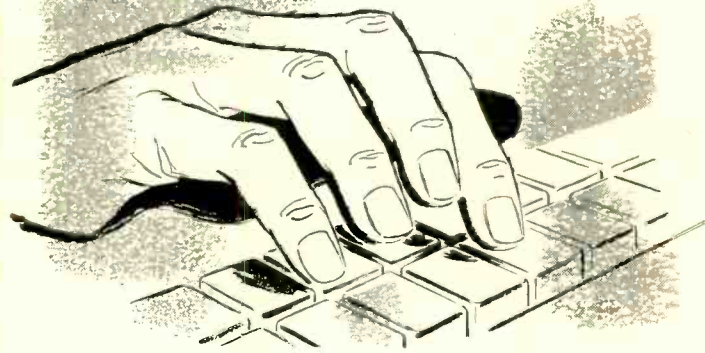

Fig. 1

controlling the apparent bandwidth of i.f. amplifier circuits. The circuit in Fig. 1 is for controlling the response of a conventional single-peaked response curve.

Here we have an i.f. stage with a single-tuned circuit L1-C1 as its plate load. A reactance tube is connected to the i.f. amplifier circuit so its plate-cathode impedance shunts the tuned circuit and appears as an inductive shunt (L2) in parallel with L1. The effective inductive reactance of L2 is determined by the gain of the reactance tube and the voltage on grid 3. The inductive reactance increases when the voltage on grid 3 is varied in one direction and decreases when the voltage is shifted in the opposite direction.

Grid 3 of the reactance tube is fed with a supra-audible signal of about 5 kc or higher. This causes the reactance of L2 to vary and change the instantaneous frequency of the i.f. amplifier plate circuit. The speed of the frequency shift is determined by the frequency of the signal fed to the reactance tube,



HERE'S ONE KEYBOARD

You can learn to play fast

And, it plays a mighty profitable tune. For, it's the Sequence Switching Keyboard on a Jackson Dynamic Tube Tester—“service engineered” to give you accurate, lightning fast tube checks.

SPEED

You'll save up to 50% in tube checking time—your first and most important task on any set, TV or radio.

SIMPLICITY

Even inexperienced help can learn to use this tube tester quickly. And, it tests every receiving type, even subminiatures.

ACCURACY

The original Dynamic Tube Tester. Checks tubes under actual load conditions. Eliminates guesswork.

FEATURES

Good-Bad, plus % Transconductance Readings—Shorts and Noise Tests—Life Line Indicator detects tired tubes—Accurate Filament Voltages—Simplified Load Setting—Sequence Switching, Keyboard Style—Line Voltage Adjustment calibrated to show actual line voltage—Easily read, smooth running Roll Chart—Bench, Portable and Counter Models.

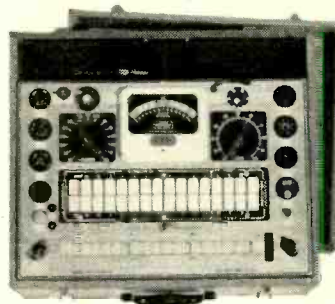

*“Service Engineered”
Test Equipment*



Before you buy any tube checker, see the **JACKSON DYNAMIC[®] TUBE TESTER** sold by all leading jobbers.

16-18 S. Patterson Blvd. • Dayton 2, Ohio • In Canada: The Canadian Marconi Company

Supreme in the FRINGE

NEW ROCKET ULTRA-POWERED

Fringe-King

- Super Broad-band Reception
- Synchronized for Color or Black and White
- Super Front-to-Back Ratio
- Gain: 8 db Low-Band 11 db hi-band
- Minimum co-channel interference

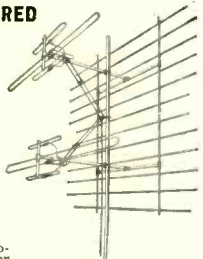

The Rocket Fringe King provides a new improved super broad-band reception in fringe and deep fringe areas that measurably increases reception pleasure. New design greatly increases uniform antenna response, with very good UHF primary and sub-primary receptivity. Front-to-back ratio higher than multi-channel yagis. When installed, we guarantee you can "see" the difference.

Model FK-232
\$23.95 ea.

With stacking harness



NEW LOW PRICE!

RADIART TELEROTOR

Radiart's famous TR-2 at new money-saving price. Powerful, rugged, weather-proof—handles installations up to 150 lbs. Control box light indicates orientation of antenna. Factory lubricated for life. Truly a good buy at our new price. Uses 8-cond. wire. 8-cond. wire.....\$0.08 ft.

\$26.97

MODEL TR-2

FAMOUS ROCKET ZOOM-UP TOWERS

- Sturdy • Reliable • Easiest Installation
- Economize with Rocket Zoom-up Towers. Offers quickest, easiest way to make an installation up to 50'. Each section telescopes inside the other—to erect, simply slide out each section in its turn—insert bolt thru section below—tighten to keep mast from turning. Each tower complete with guy rings, bolts, and mounting base suitable for peak or flat roof. Handsome and sturdy Rocket Zoom-ups offer you economy and long life. Order by size.

20' \$ 9.95 30' \$15.95
40' 19.95 50' 29.95

(Deduct 10% discount in lots of 3)

SUPER RECEPTION IN FRINGE AREAS AT BARGAIN PRICES!

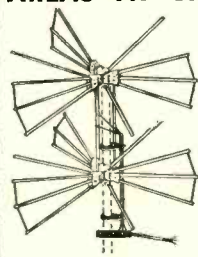

360° Super Directive Electronically Rotates in All Directions
VHF-UHF CHANNELS 2-83

Exclusive Engi-**\$23.50** neering and design cuts costs to
Powerful, 24 element 2 bay Directronic antenna is electronically beamed to any transmitter in fringe area by 6-position selector switch. No motors or electricity. Extremely high gain. COMPLETE WITH 6-POSITION DIRECTRONIC BEAM SELECTOR, 75' TUBULAR TREN. CABLE, UNIVERSAL U-CLAMPS.

Order model AX-524.

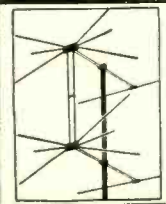

2 BAY 16 ELEMENT CONICAL ARRAY

\$4.99 EACH in Single Lots
LOTS OF 3 \$5.30 Each
Hi-gain 16-element conical with sturdy 3/4" hi-tensile aluminum elements. For fringe use. Complete coverage of Ch. 2 thru 13. Packed in cartons of three 16-element arrays, per carton, with tie rods, at \$14.95 per carton. Single 16-element array, \$ 5.90
1 carton 6 arrays—
no tie rods..... 13.50
4 bay stacking assembly..... 12
No. 4B..... 1.95

Low-loss Tubular twin lead—100' coil.....\$4.95
Lt. arrestor-tubular or flat lead..... .69
7" UHF Mast standoffs..... .12
7" UHF Screw standoffs..... .06

UHF CORNER REFLECTOR

ONLY \$2.99 SINGLE LOTS \$3.50 EACH
EACH IN LOTS OF 6

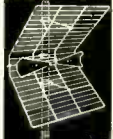

This hi-gain UHF Corner Reflector can only be offered you at this low price for a short time. 8 to 11 db gain across UHF band. Order Model F-6.

ALL PRICES F.O.B. CLEVELAND, OHIO
Do not remit more than complete purchase price. Pay shipping charges on receipt of goods. 25% deposit on all C.O.D. orders, please. Money-back guarantee. Prices Subject to Change Without Notice

National Electronics
OF CLEVELAND
THE HOUSE OF TV VALUES
209 Delco Bldg. Cleveland 3, Ohio

RADIO-ELECTRONIC CIRCUITS

and the amount of reactance variation is determined by the amplitude of the applied a.c. voltage.

The solid curve in Fig. 2 illustrates the typical peaked response of a conventional i.f. amplifier circuit. The dashed lines show how the peaked response of the tuned circuit is shifted periodically by equal amounts above and below the normal resonant frequency. The effect of this periodic detuning of the i.f. circuit is an apparent flat-topped band-pass curve.

The inventor also describes how the effective width of a narrow flat-topped i.f. response curve may be increased

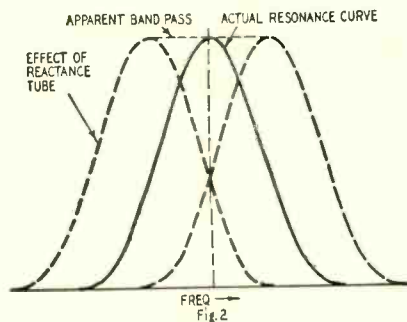

by using the reactance tube to modulate the receiver's local oscillator. Frequency-modulation of the local oscillator results in rapid shifting of the intermediate frequency so the upper and lower side-bands are alternately passed through the relatively narrow i.f. circuits.

The inventor also describes a method of using carrier strength to control the sweep width produced by the reactance tube. Thus, the bandwidth can be automatically increased on strong signals and decreased to reduce background noise on weak ones.

NOVEL PARALLEL-T USE

Some form of simple mixer circuit is often used to compare the frequency of a variable oscillator with a frequency standard. In many instances, the less stable of the two oscillators tends to lock in with the other when the frequency difference is small. This makes it difficult, if not impossible, to get an exact zero beat between the reference oscillator and the one whose frequency is to be measured.

In *Electronic Engineering* (London, England), J. S. Nisbet shows a parallel-T network as a linear mixer for two signal sources in a frequency meter. One oscillator connects to the input end of the parallel-T and the other to the output end. Output for the detector can be tapped off of either T—from the junction of the series resistors or from the series capacitors. At the null or resonance frequency of the network, the transfer impedance between the ends of the circuit is zero, so no voltage is fed from one oscillator to the other. With the circuit shown, coupling and pulling between oscillators are avoided to a point where the frequency difference is less than a cycle at 50 kc. A

GET INTO ONE OF THESE GREATER OPPORTUNITY FIELDS

Electricity or Radio-Television

TRAIN IN THE GREAT SHOPS OF **COYNE** OLDEST, BEST EQUIPPED SCHOOL OF ITS KIND IN U. S.

Prepare for your future NOW. Get practical training in TELEVISION—RADIO—ELECTRICITY—ELECTRONICS—all vital in Industry. Prepare now for a better job that also offers a real future in the years ahead. Learn on real equipment at Coyne—no advanced education or previous experience needed.

Approved for Veterans—finance plan—enroll now, pay most of tuition later. Part time employment service while training if needed.

FREE BOOK Clip coupon for Big Free Illustrated Book. No salesman will call. Act NOW.

B. W. COOKE President FOUNDED 1899
COYNE ELECTRICAL SCHOOL
A TECHNICAL TRADE INSTITUTE CHARTERED NOT FOR PROFIT.
500 S. Paulina St., Chicago, Dept. 64-81H
ELECTRICITY • TELEVISION • RADIO • REFRIGERATION • ELECTRONICS

B. W. COOKE, Pres.
COYNE ELECTRICAL School
500 S. Paulina St., Chicago 12, Ill. Dept. 64-81H

Send FREE BOOK and details on:

RADIO-TELEVISION ELECTRICITY

NAME.....

ADDRESS.....

CITY..... STATE.....

New
PRINTED CIRCUIT BOARDS
NOW USED IN HEATHKITS
SEE PAGE 69

URGENT! URGENT!
ELECTRONIC TUBES
We Pay Spot Cash for:
RADIO, TV—all types
State types, condition of merchandise, quantities and price.
COLUMBIA ELECTRONICS CORP.
115 Liberty Street, N. Y. C.

ARKAY KITS WORLD'S FINEST
RADIO PHONOGRAPHS TV
TEST EQUIPMENT HI-FI
Write for FREE Brochure
RADIO KITS, INC. • 120 Cedar St., N. Y. 6

RADIO-ELECTRONIC CIRCUITS

British type Y63 electron-ray indicator tube is used as a detector and zero-beat indicator. A 6E5 or similar type may be used instead.

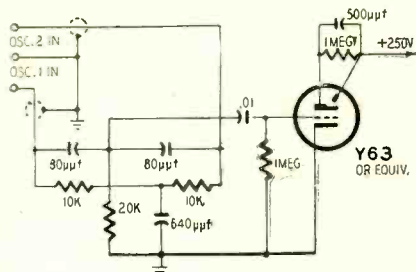

In the usual parallel-T designed as a filter or for the feedback circuit of an oscillator, the constants are selected for maximum possible attenuation at the null frequency and minimum losses elsewhere in the spectrum. In this application, the attenuation must be high through the comparatively wide band of frequencies where pulling may occur, so the values are slightly different from those in normal filter and null circuits.

S-METER CIRCUIT

Many receivers used by amateurs and SWL's lack S-meters for measuring relative signal strength. Instructions for installing an S-meter usually require several components and some circuit alterations. This circuit, described by G2HR in *The Short Wave Magazine* (London, England), does not require any alteration of the original circuit and uses only four components including the meter.

In this circuit, a diode and microammeter are used as a high-resistance r.f. voltmeter. The meter is shunted by a germanium diode and is in series with a resistor and capacitor between ground and the plate of the last i.f. amplifier. The values for R and C may have to be determined by trial and er-

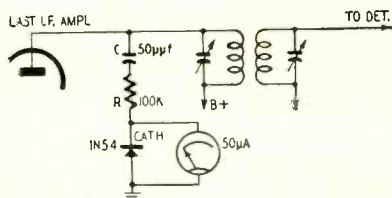

ror. C should not be much larger than about 50 µf and R should be about 100,000 ohms. The type of diode was not specified in the article. A 1N54 or equivalent should work satisfactorily.

Different values of R and C may be required with meters less sensitive than the 50-µa unit shown.

The sensitivity of most all-wave receivers varies from band to band. If you calibrate the S-meter with a laboratory-type signal generator, you can select sets of R-C constants to give the same S reading for equal signal inputs on each band. The R-C combinations can be connected into the circuit as needed with a multipurpose switch ganged to the band switch in the receiver. END



more servicemen prefer

STANCOR
REPLACEMENT TRANSFORMERS

than all other brands combined*

because they like the . . .

- ease of installation
- completeness of the Stancor line
- availability of accurate replacement information
- rugged, breakdown-proof construction
- quick delivery from distributor's stock

Brand Name Surveys, Chicago, Illinois; brand preference survey of electronic replacement components, May, 1954. Answered by servicemen from all over the U.S.

FREE NEW STANCOR GENERAL CATALOG listing over 500 transformers for TV, radio, high fidelity, communications and other electronic applications. Available from your local Stancor distributor or by writing Standard Division, Chicago Standard Transformer Corporation.

Stancor transformers
are listed in Photofact Folders and Counterfacts



CHICAGO STANDARD TRANSFORMER CORPORATION

3592 ELSTON AVENUE • CHICAGO 18, ILLINOIS

EXPORT SALES: Roburn Agencies, Inc.
431 Greenwich Street, New York 13, N. Y.

New TV DYNATRACER

THE 3-IN-1 TEST TOOL:

SIGNAL TRACER • VOLTAGE TRACER
COMPONENT CHECKER

*Presents a Different, Simplified Method
of Troubleshooting*

REQUIRES NO ADDITIONAL EQUIPMENT

The self-powered DYNATRACER isolates trouble to a stage or component . . . tracing signals through any Video, Sound, Sync, AFC, Horizontal or Vertical Sweep Circuit.

What's more, the remarkable DYNATRACER traces voltages (50/500v AC/DC) and instantly locates open, shorted, intermittent or leaky (up to 20 MEGOHMS) condensers, resistors, coils, transformers, etc.

Save time, labor & money with the DYNATRACER . . . the most indispensable TV repair tool ever made.
Complete troubleshooting manual enclosed.

Century ELECTRONICS CO.
211-04 99th Ave. Dept. 117 Queens Village, N. Y.

Only
\$4.95

Postpaid
U.S.A. only
Queens Village, N. Y.



For a limited time only . . .

FREE TRIAL OFFER

Send No Money With
Order — No C.O.D.

If the marvelous DYNATRACER isn't all we say, send it back within 10 days without cost or obligation. But we know you'll agree that the DYNATRACER is the best friend you ever had on your work bench. So order your DYNATRACER now!

When answering advertisements please mention
RADIO-ELECTRONICS



The Miller K-Tran I.F. Transformers are available for the following frequencies: 262 KC, 455 KC, 1500 KC, 4.5 MC and 10.7 MC.

4.5 MC transformers are for use in television receivers having an intercarrier sound channel. 10.7 MC transformers find their main application in FM receivers and tuners.

All transformers are shell core permeability tuned, thus providing a magnetic shielding of the windings and reducing the influence of the aluminum can. Stable silver mica fixed capacitors are enclosed in the low-loss terminal base.

CAT. NO.	Frequency	Use	NET PRICE
12-H1	262 KC	Input Transformer	1.50
12-H2	262 KC	Output Transformer	1.50
12-H6	262 KC	Output Transformer diode filter	1.59
12-C1	455 KC	Input Transformer	1.32
12-C2	455 KC	Output Transformer	1.32
12-C6	455 KC	Output Transformer diode filter	1.41
12-C7	455 KC	Input Transformer for Battery Radios	1.32
12-C8	455 KC	Output Transformer for Battery Radios	1.32
12-C9	455 KC	Input Transformer for AC-DC Radios	1.32
12-C10	455 KC	Output Transformer for AC-DC Radios	1.32
13-W1	1500 KC	Input Transformer	1.44
13-W2	1500 KC	Output Transformer	1.44
13-PC1	455 KC	Input I.F. Transformer For Printed Circuits	1.44
13-PC2	455 KC	Output I.F. Transformer For Printed Circuits	1.44
6203	4.5 MC	Input or Interstage Transformer	1.65
6204	4.5 MC	Discriminator Transformer	1.98
6205	4.5 MC	Ratio Detector Transformer	1.98
1463	10.7 MC	Input or Interstage Transformer	1.65
1464	10.7 MC	Discriminator Transformer	1.98
1465	10.7 MC	Ratio Detector Transformer	1.98
SUB-MINIATURE K-TRAN - Only 1/2" Square by 1 1/2" High			
10-C1	455 KC	Input Transformer	1.50
10-C2	455 KC	Output Transformer	1.50

(Available through your local distributor.)

*Manufactured under "K-TRAN" patents of Automatic Mfg. Co. *K-TRAN is registered trademark.

J. W. MILLER COMPANY
 5917 South Main Street • Los Angeles 3, California
 Canadian Representative: Atlas Radio Corporation, Ltd. 560 King Street, W. Toronto 2B, Canada

"1000 ELECTRONIC QUESTIONS & ANSWERS"
 By R. J. Fredericks
Test YOUR Electronic I.Q.!!!

A new manual containing 1000 interesting problems and puzzles encountered in everyday, practical work. Chapters cover all principle topics, including test equipment, FM, TV, Hi-Fi, transmitters, receiver and many others. Ideal practice for service and lab technicians, amateurs, experimenters and students. **ORDER TODAY!** 10-day money back guarantee.

only
\$1 ppd.
 FULL PRICE

RADIO SOUND PUBLICATIONS
 Box 38, Utopia Station, Flushing 66, N.Y.

New **HEATHKIT**
VFO
 AND
HAM GEAR
 ON PAGE
76

QUESTION BOX

NOISE-FIGURE MEANING

What is noise-figure, how is it measured, and how is it used to compare receivers? I see the term used very often, but have never yet met anyone who can tell me just what it really means.—M.B.B., Denver, Colo.

Noise-figure is a factor used to indicate the quality of an actual receiver compared to a theoretically perfect set with the same bandwidth and absolutely no internal noise. The noise-figure is the signal-to-noise power ratio of the ideal receiver divided by the signal-to-noise power ratio of the actual receiver. The ability to read weak signals increases as the noise-figure of the receiver decreases. The diagram shows a basic noise generator used in measuring noise-figure.

The circuit is designed around a temperature-limited diode—a diode operated with enough plate voltage to attract to the plate all the electrons emitted by the filament. Under these conditions, the diode produces a wide-band r.f. hiss or noise with amplitude directly proportional to the plate cur-

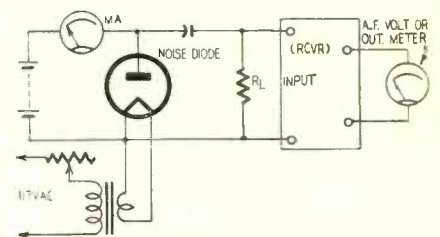

rent. Plate current and amplitude of the r.f. output are controlled by varying the filament voltage.

The noise voltage is produced across R_L (a noninductive resistor) with resistance equal to the antenna or lead-in impedance. Connect the generator and output meter to the receiver as shown. With the receiver operating at maximum sensitivity and the noise generator turned off, advance the set's volume control to obtain an arbitrary reading on the output meter. Then turn the generator on and increase the filament voltage until the output meter reading increases 3 db.

The noise-figure (F) of the receiver is equal to $20 \times I \times R_L$, where I is diode plate current in amperes. In decibels, F is 10 times the logarithm of the figure obtained with the equation above.

The physical construction of a tube largely determines the noise it introduces. Thus, a triode amplifier will produce less noise than the very best of mixer tubes.

Bibliography:

F. E. Terman, *Radio Engineering*, 3rd Edition, pp. 770-773.

Byron Goodman, "How Sensitive Is Your Receiver?" *QST*, Vol. 31, No. 9, September, 1947, pp. 13-21.

William Orr, "The Silicon Crystal Noise Generator," *CQ*, Vol. 8, No. 6, June, 1952, pp. 25-27.

Edward F. Tilton, "Noise-Generator Techniques for the V.H.F. Man," *QST*, Vol. 33, No. 8, August, 1949, pp. 20-21, 90-92.

QUESTION BOX

SCOPE SWEEP REVERSAL

I have an Eico 5-inch scope. I want to install a switch to reverse the sweep direction so response patterns will have the same time-versus-frequency direction as in set manufacturers' service manuals. Please show how this is done.—R. D., Springfield, Mo.

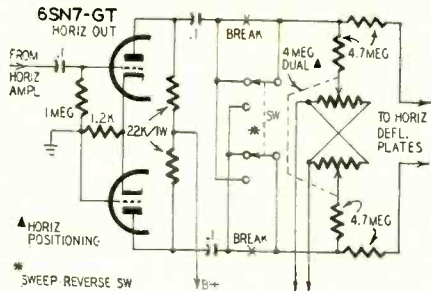

The diagram shows the horizontal output circuit of the Eico 425 scope with the sweep reversal switch added. The signals on the plates of the push-pull horizontal amplifier are 180° out of phase so the sweep changes direction when the plate output leads are reversed by throwing the switch.

TV TRANSMITTER DATA

I want to construct an amateur TV station and a closed-circuit TV camera chain for experimental purposes. Can you supply practical circuits of simple sync generators, timing circuits, flying-spot scanners, r.f. amplifiers, and modulators? I have lots of theoretical material from magazines and textbooks but no practical circuits. I need practical circuits with typical values. Can you supply circuits or references that will be useful to me?—J. McN., Wyandanch, N. Y.

The article "Experimental TV Relay," RADIO-ELECTRONICS, May, 1949, describes a 10-watt transmitter with line amplifier, and modulator. Additional references are given in the following bibliography:

- G. Zaharis. "Television Synchronizing Generator," *Electronics*, Vol. 23, No. 5, May, 1950, pp. 92-93.
- L. E. Flory, W. S. Pike, J. E. Dille, and J. M. Morgan. "Pack-Carried Television Station," *Electronics*, Vol. 25, No. 6, June, 1952, pp. 92-95.
- S. R. Patremio. "The Du-Mitter," *Radio & Television News (Radio-Electronic Engineering Section)* Vol. 49, No. 2, February, 1952, pp. 3-5.
- J. R. Popkin-Clurman. "Simplified Ham TV Station," *Radio & Television News*, Vol. 43, Nos. 5-6, Vol. 44, No. 1, May, June and July, 1950. **END**

Interest in the Question Box, as indicated by letters received, is not high, and the question has arisen as to whether the space might not be better devoted to other subjects. What do our readers think? Should we: (1) continue the Question Box as is; (2) discontinue it; or (3) substitute some other material, and if so, what? Please mail your vote to Question Box, Radio-Electronics, 25 West Broadway, New York 7, N.Y.

NOW! HANDLE TELEVISION REPAIRS THIS EASY "SHORT CUT" WAY!

Eliminate useless testing . . . Fix TV sets twice as fast



PIX-O-FIX TV TROUBLE FINDER GUIDES

by Ghirardi & Middleton

PIX-O-FIX No. 1—This handy little, pocket-size dial chart and booklet identifies 24 of the most common troubles by actual television screen photos. Gives 192 causes and 253 remedies for these troubles. Price separately, \$1.25.

PIX-O-FIX No. 2—Covers 23 additional and more "advanced" troubles not included in Pix-O-Fix No. 1. Tells what to do—just how to do it. Together, the two volumes are a comprehensive guide to fast "picture analysis" servicing of any TV set. Price separately, \$1.25.

ONLY \$2 for the two
Check combination offer in coupon.

Use PIX-O-FIX to handle most television troubles by fast, easy picture analysis

Cut TV test time to minutes. Make repairs fast and right! Just turn the dial of your PIX-O-FIX. When the picture in the PIX-O-FIX window matches the screen image on the television set you're repairing . . . presto! . . . you've got your clue. PIX-O-FIX then directs you to the causes of this particular trouble. Next it indicates the exact section of the receiver in which the trouble has probably happened. Then it gives step by

step repair instructions. Usually, it even specifies the component likely to be at fault. Quick tests to use on it are explained . . . or parts substitution recommended where this is best.

The two PIX-O-FIX units cover 47 different TV troubles . . . just about anything you're likely to be called on to fix. Operation is simple and easy. Our money-back guarantee protects you fully.

10-DAY MONEY-BACK GUARANTEE

Dept. RE-94, RINEHART & CO., Inc., 232 Madison Ave., New York 16, N. Y.

Enclosed find \$_____ for which please send the following:
 Pix-O-Fix No. 1 (\$1.25) Pix-O-Fix No. 2 (\$1.25)
 COMBINATION OFFER . . . both Pix-O-Fix No. 1 and No. 2 at special price of only \$2.00 for the two.
 If not satisfactory, I will return Pix-O-Fix postpaid in 10 days and you guarantee to refund my purchase price.

Name _____
 Address _____
 City, Zone, State _____

OUTSIDE U.S.A.—\$1.50 each, \$2.50 for both. Same 10-day return privilege with money refunded.

JUST A FEW SAMPLES FROM OUR NEW FALL CATALOG!!

AUTOMATIC SYNCHRONOUS DUAL TIME DELAY Cramer Relay Model 1-C2H



\$1.98 ea!

worth \$12.50

Dual continuously interrupting switch timer. 60 cycle AC synchronous motor revolves at 1/2 RPH operating 2 single pole single throw 15 ampere switches. One switch is cammed so that it is open for one hour and then closed for one hour. The other is cammed to open for one 5 minute period every two hours. The two cams are so arranged that the two switches are in the open position simultaneously for 5 minutes out of each 2 hour period. Guaranteed Brand New. Overall size — 4 x 3 x 2 3/8". Shpg. wt. 1 1/2 lbs. Stock No. 89-G-1C2H. Worth \$12.50.

Safety Before Sorrow!!

Miniature 20 amp Circuit Breakers

Single Pole — 98¢ ea.

Non-Trip Free 94¢ ea. Lots of 6

Good for 20 Amps 115 Volts AC/DC

DOOR INTERLOCK SAFETY SWITCHES

TYPE A
GE Pressure Type
10 Amp-125 Volts



TYPE B
BRYANT AC Receptacle
Type 10 Amp-125 Volts



Your Choice Type A or B 79¢

Lots of 10 73¢

HEADSET "POT-LOCK"

High Impedance U.S. Govt. 98¢ ea.



Fantastic Value!!

HAYDON 3.6 Watt — 1 RPM TIMING MOTORS 110 V — 60 Cy. Reg. \$7.50 Value Quantity Limited \$1.39



FM Dipole 98¢ VEE-DX MODEL DRFM



Concord Radio

54 VESEY ST. NEW YORK 7, N. Y. •

CONCORD RADIO 53 Vesey St., N. Y. 7, Dept C9
 20% deposit with C.O.D. MINIMUM ORDER \$5.00
 Send new CONCORD CATALOG!

NAME _____
 ADDRESS _____
 CITY _____ ZONE _____ STATE _____

Digby 9-1132

HERSHEL RADIO CO. BIGGEST BUYS!

FIL. TRANSFORMER

PRI. 117V. 60 cycle
 Sec.,
 #1 6.4v 12amp.
 #2 6.4v 10amp.
 #3 5.5v 3amp.
 #4 5.5v 3amp.
 #5 5.5v 3amp.
 #6 2.5v 1.75amp.
\$4.95
 SIZE: 5 1/16" x 5 1/16" x 5 1/4" H.

RCA OUTPUT

TRANSFORMER
 P.P. 616'S 25 watt
 PRI 5000 Ohms
 output. Sec. #1
 500 Ohms. Sec.
 #2 600 Ohms.
 Sidelane 15 to
 15,000 cy. flat.
\$1.95

FILTER UNITS

\$2.95 FL-41
 Phone plug and
 Jack JK36 2
 BINDING POST.
 Prevents RF
 Feed Back. Has
 2 RF CHOKES,
 72 UH Powered
 Iron Cores.

2 METER ANTENNA

GROUND PLANE
 CT2 66-AFJ
 144 MC to
 156 MC
\$9.95

OIL COND.

MFD	VDC	PRICE
.05	3000	\$1.95
.05	7500	2.29
.1	4000	1.29
.1	7000	1.75
.1	7500	2.49
.5	2500	1.75
2 x .5	8000	1.49
1	3000	2.49
1	3600	2.95
1	5000	4.95
2	600	.49
2	1000	.95
2	3000	4.95
4	1000	1.95
6	600	1.29
7	600	1.39
8	600	1.75
8	1000	2.49
10	600	2.49
10	1500	4.95

DUAL 4-1000

2x4 600 3.95
 13.5 220 vac. 1.95
 6 330 vac. .95

PAPER CAN

MFD	VDC	PRICE
250	10	\$.39
500	12	.49
1000	3	.69
1000	15	.95
1000	25	1.29
1200	10	.95
1600	15	1.29
24000	3	1.49
117	110 vac.	1.45

PHOTO-FLASH SPECIAL!

MFD	VDC	PRICE
525	450	\$9.95

1 KW ANT. CHANGEOVER

RELAY
 110 VAC
 60 Cycle
 15 Amp
 2500 Volt
 D. P. D. T.
\$9.95

BUTTERFLY CONDENSERS

TYPE A-106-330 MC-
 Antenna Type
 TYPE B-300-1000 MC-
 Uses 388AS tube
 TYPE C-300-1000 MC-
 Clip for Xial Bet.
 TYPE D-135-485 MC
YOUR CHOICE \$4.95

CHOKO SPECIALS!

DUAL 4.5 120MA	\$ 1.95
4.5 70MA	
DUAL 1H 400MA	\$2.95
4.2H 75MA	
15H 80MA 385 OHM	\$ 1.95
2-7H. Swinging 550MA	\$ 5.95

MODULATION and DRIVER TRANSFORMERS

\$4.95 for Both
 Modulation trans. 815 Class
 AB2 56 Watt
 DRIVER, 65N7
 to Modulator.

VIBRATOR SUPPLIES

PE 117C YOUR CHOICE \$9.95
 Input 6 or 12V DC to Supply Fil. and Plate Power. Used with BC 659.
PE 204C
 Input 12V DC. Supply Fil. and Plate Supply. Used with EE99.

HERSHEL RADIO CO.

5245 GRAND RIVER
 Detroit 8, Michigan
 Phone TYler 8-9400

TERMS: Cash with order or 25%
 DOWN—BALANCE C.O.D. NET
 10 DAYS RATED ACCOUNTS
 ALL PRICES NET F.O.B. DETROIT
 Merchandise Subject to Prior Sale

NEW! ATLAS CJ-30 COBRA-JECTOR

INDESTRUCTIBLE FIBER-GLASS
 ALL WEATHER
 WIDE ANGLE DISPERSION



List \$40.00
NET \$24.00
 Complete with Driver.

Weatherproof
 Line Matching
 Transformer
 as shown,
 Net \$5.10.

New versatile all-purpose projector—excellent for paging & talk-back, intercom, marine, and industrial voice & music systems. Penetrating articulation assures wide angle intelligible coverage even under adverse sound conditions. "ALNICO-V-PLUS" magnetic assembly. Double-sealed against all weather. Omni-directional mounting bracket. Quick, easy installation. An amazing "power package"—Specify the CJ-30 for the "tough" jobs!

Input Power (continuous)	15 watts
Input Impedance	8 ohms
Response	250-9000 cps
Dispersion	120° x 60°
Dimensions	Opening, 14" x 6" Overall Length, 14"



WRITE FOR COMPLETE CATALOG
ATLAS SOUND CORP.
 1443—39 St., Bklyn. 18, N. Y.
 In Canada:
 Atlas Radio Corp., Ltd., Toronto, Ont.

Tremendous Opportunities in COIN TV and COMMERCIAL TV

TRANSVISION

offers
SPECIALLY DESIGNED TV SETS
 with important
 Pat. Pend. Features
 for use in

Hotels, Motels, Hospitals, and Public Locations

Also:
Master Amplified TV Antenna Systems

Get details now.
 TRANSVISION, INC.
 NEW ROCHELLE, N. Y.



MAIL THIS COUPON TODAY
 TRANSVISION, INC., NEW ROCHELLE, N. Y. Dept. RES
 Rush full details on COIN OPERATED TV.
 Name _____
 Address _____
 City _____ State _____

RADIO BUSINESS

Merchandising and Promotion
 Cornell-Dubilier Electric Corp., South Plainfield, N. J., and Radiart Corp., Cleveland, developed a new animated



display for the complete line of CDR rotors which they manufacture. The illuminated display turns to show the rotating action of these rotors.

Pyramid Electric Co., North Bergen, N. J., introduced a new type of pack-



aging which aids distributors in the stocking of and displaying of the company's line of tubular electrolytic capacitors.

Hallcrafters Co., Chicago, has built new point-of-sale material for com-



munications dealers around its recently sponsored expedition to Clipperton Island. A group of five hams set out for this Pacific atoll with the idea of establishing a "new country" which world-wide hams could add to their scores of countries worked.

Sprague Products Co., North Adams, Mass., is reprinting its "Beware the Service Bargain" flyer which originally appeared as an advertisement in Radio-Electronics and other trade magazines. It is available from the company in quantities at a nominal cost.

Rek-O-Kut Co., Long Island City, N. Y., designed a new stroboscopic speed

test disc for checking turntable speeds. It is available free upon request.



Shure Brothers, Inc., Chicago, developed a new plastic cartridge replacement kit housing three cartridges which will replace 192 of the cartridges most likely to need replacement.

General Electric Tube Department, Schenectady, N. Y., produced a new



one-minute movie for TV showings, illustrating for the public what it takes to fix a TV set. It is part of the G-E campaign to promote better public understanding of the TV service technician's function. The film is available to G-E tube distributors for local TV showings. A pamphlet illustrated by stills from the film also is available from either the company or its distributors.

Allen B. Du Mont Laboratories, Television Receiver Division, Clifton, N. J., is offering purchasers of new Du Mont



THANK YOU, Mr. Serviceman

for naming



your preferred brand!

In a recent nationwide survey*, radio and TV servicemen were asked this question: "What brand of replacement speakers do you prefer? Why?" QUAM was first in number on mentions—almost 30% more than the next most preferred brand.

* Conducted by Brand Name Surveys of Chicago, Illinois, May 1954.



- "Adjust-a-Cone feature-ruggedness"
- "Complete range of sizes and types"
- "Stand up best in service"
- "Include hardware for easier installation"
- "Good construction"
- "Listed in Sams' Photofacts"
- "Heavier magnets"
- "Good quality at a reasonable price"
- "Always satisfactory"

ask for **QUAM** the quality line, for **ALL** your speaker needs

QUAM-NICHOLS COMPANY

236 EAST MARQUETTE ROAD • CHICAGO 37, ILLINOIS

Terrific Hi-Fi
VALUES
HEATHKIT
AMPLIFIERS
and PREAMP



PAGE

76, 77

RECEIVING TUBES BRANDED—INDIVIDUALLY BOXED GUARANTEED 6 MONTHS

6AQ5 ..\$.50	6C4\$.40	7A7 ...\$.69
6AT6 .. .40	6SA7GT .. .55	7B669
6AU6 .. .45	6SK7GT53	7B869
6AV6 .. .40	6SN7GT59	7C559
6BA6 .. .40	6V6GT50	7E639
6BE6 .. .40	6X440	7Y469

(Write for types not listed)

TERMS: 25% with order, balance COD. Orders over \$15.00 with full remittance, prepaid to you in Continental U.S.A. Prices subject to change without notice. Minimum order \$5.00.

DORIAN ELECTRONICS CORP.
89-39 163rd St., Jamaica 32, N.Y.

N.J.R.T. TUBES 70% to 90% OFF LIST

GUARANTEE ALL NJRT TUBES ARE BRAND NEW AND FULLY GUARANTEED FOR ONE YEAR

Type	Price	Type	Price	Type	Price	Type	Price	Type	Price	Type	Price
1A7GT	.45	6AF6	.75	6BF5	.55	6SA7GT	.41	12A76	.35	25BQ6GT	.75
1B3GT	.67	6AG5	.49	6BG6G	1.20	6SB7Y	.76	12A77	.65	25L6GT	.45
1H5GT	.38	6AH4	.67	6BH6	.45	6SC7	.59	12A78	.38	25W4GT	.45
1L4	.50	6AK5	.59	6BJ6	.41	6SD7GT	.39	12A79	.55	35A5	.49
1NSGT	.62	6AL5	.39	6BK7	.89	6SK7GT	.39	12AV6	.50	35B5	.38
1R5	.48	6AQ5	.39	6BL7GT	.65	6SL7GT	.49	12AV7	.60	35C5	.38
1S5	.40	6AQ6	.36	6BQ6GT	.77	6SN7GT	.55	12AX4GT	.55	35L6GT	.45
1T4	.48	6AQ7	.68	6BQ7A	.92	6SX7	.37	12AX7	.55	35W4	.45
1U4	.48	6AR5	.45	6BZ7	.95	6T8	.75	12BA6	.40	35Z5GT	.45
1U5	.40	6AS5	.50	6C4	.39	6U7	.56	12B7	.57	45	.53
1X2	.65	6AT6	.39	6CB6	.45	6U8	.59	12BE6	.41	50B5	.41
3A4	.45	6AU4GT	.70	6CD6G	1.15	6V6GT	.45	12BH7	.65	50C5	.41
3Q4	.48	6AU5	.82	6F6	.45	6W4GT	.45	12BY7	.65	50L6GT	.59
3Q5GT	.48	6AU6	.45	6H6	.53	6W6GT	.45	12BZ7	.65	70L7GT	1.07
3S4	.48	6AV6	.39	6J5	.40	6X4	.39	12SL7GT	.49	76	.42
3V4	.50	6AX4GT	.59	6J6	.50	6X5GT	.35	12SN7GT	.50	81	1.25
5U4G	.55	6BA6	.40	6K6GT	.39	7E6	.40	12SR7met.	.55	117L7GT	1.19
5Y3GT	.39	6BA7	.57	6L6	.62	7X6	.58	12V6GT	.50	117P7GT	1.39
5Y4G	.39	6BC5	.49	6R7	.49	7L7	.77	12X4	.35	117Z3	.39
6AB4	.42	6BD6	.45	6S4	.39	12AL5	.40	19B6G6	1.15	807	1.25
6AF4	.92	6BE6	.39	6S8GT	.51			19T6	.75		

T.V. PIX TUBES
BRIGHTENER.....\$1.39

PEE-WEE "HIDE-A-WAY" ANTENNA
no bigger than a half dollar..... 79c

HI-PO TV RECTIFIER TUBES LAST LONGER

Makes Picture brighter, larger
HI-PO 567 TO REPLACE \$1.39
HI-PO 6S78 TO REPLACE \$1.95
6SN7GT

Free Five 1L4 tubes individually cartoned list value \$11.25 with every order of \$25.00 or more.

Many 7 volt types not listed. All tubes individually boxed. Orders under \$10 subject to \$1 handling charge. Tubes offered subject to prior sale. Prices subject to change. All orders shipped F.O.B. 25% deposit required on c.o.d. shipments.

SEND FOR FREE TUBE LISTING



NEW JERSEY TELEVISION SUPPLY CO.

Sole Distributor of NJRT Tubes

906A WESTFIELD AVE., ELIZABETH, N. J. EL. 5-3900

HI-FI FANS—

SPECIAL FOR YOU—two books to help you get better performance from your high-fidelity equipment.

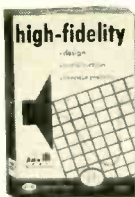

128 Pages
Over 100
Illustrations.
\$1.50

High-Fidelity -- Design, Construction, Measurements

For the real audio fan! Assumes you know fundamentals and from there outlines practical methods for working toward perfection in a hi-fi system. Unique 3-way approach covers hi-fi from standpoint of design, construction and measurements.

High-Fidelity Techniques

A classic in the field! No true hi-fi can afford to be without this one! You'll get more practical information from James R. Langham's breezy observations on how to get top performance from each high-fidelity component, than you would from many more conventional books. Get your copy today.

See coupon on page 152



112 Pages,
Illustrated
\$1.00

GERNSBACK PUBLICATIONS, INC.

25 West Broadway

New York 7, N.Y.

Publishers of RADIO-ELECTRONICS

RADIO BUSINESS

TV receivers a toy television service truck for the kiddies. The same truck will be sold nationally in retail toy stores.

CBS-Hytron, Danvers, Mass., developed another in its series of service aids, a new service coat, available from its distributors.

RCA Tube Division, Harrison, N. J., announced the winners in its recent \$50,000 "Tell and Sell" tube contest in which distributor salesmen who aided the winning service technicians were awarded duplicate prizes. G. Lee Hurlburt, Lakewood, N. J., service technician won the first prize, a 1954 De Soto hard-top convertible. E. Frank Roberts, Cleveland, Ohio, won second prize, a \$1,000 U.S. Savings Bond. Allan J. Holmes, Orange, N. J., won third prize, a deluxe RCA Victor TV-radio-phonograph console combination. Duplicate distributor prizes went to Robert Bursley, Krich-New Jersey, Newark, N. J., first prize; L. Fromwiller, Maine Line Cleveland, Inc., Cleveland, Ohio, second prize; and Bruce Douglas, Krich-New Jersey, Newark, N. J., third prize.

Calendar of Events

A Symposium on Propagation, Standards, and Problems of the Ionosphere, September 8-11 at the new Boulder (Colorado) Laboratories of the National Bureau of Standards.

Fifth Annual Fall NATESA Convention, September 24-26, Morrison Hotel, Chicago.

High-Fidelity Show, September 30-October 2—Palmer House, Chicago.

Second National Conference on Tube Techniques, October 26-28, Western Union Auditorium, 60 Hudson Street, New York, N. Y.

Fourth Annual Eastern Joint Computer Conference and Exhibition, December 8-10, Bellevue-Stratford Hotel, Philadelphia, Pa.

Production and Sales

RETMA reported the production of 2,301,005 TV sets and 4,048,904 radios during the first 21 weeks of 1954. This compares with 3,309,757 TV sets and 6,102,711 radios produced in the same 1953 period. The association noted that during the first five months of this year 7,713 color TV sets were manufactured.

RETMA reported the manufacturers' sale of 3,275,301 cathode-ray tubes for the first five months of this year compared with 3,633,288 for the 1953 period.

New Plants and Expansions

Cornell-Dubilier Electric Corp., South Plainfield, N. J., formally opened its new plant in Sanford, N. C., last June. Leslie A. Johnson, newly appointed vice-president of the corporation, is plant manager.

Howard W. Sams & Co. formally dedicated its new plant at Sams Park, 34th and Sutherland Ave., Indianapolis, recently. The Sams operations will be centered in the new building and the plant at 2201 East 46th St.

Allen B. Du Mont Cathode-ray Tube Division, Clifton, N. J., opens permanent headquarters for its West Coast sales and service depot in Los Angeles this September.

YOU CAN WIN A NEW FORD!

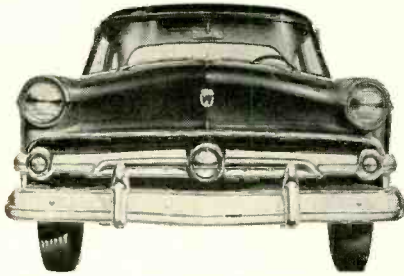

Nothing to buy! Nothing to sell!

**Just Illustrate and Explain
a New Application for
International Rectifier Corporation
Selenium Diodes**

**50 PRIZES
Grand Prize**

**New Ford V-8 Mainliner Tudor Sedan
and 49 other
valuable prizes**

INTERNATIONAL RECTIFIER CORPORATION'S Selenium Diode Application Contest is open to everyone! Here's all you have to do — pick up an official entry blank from your favorite parts distributor. Illustrate and explain a new practical application for International Rectifier Selenium Diodes. Have the entry blank countersigned by your distributor's salesman and then forward it to us before January 1, 1955. Rules and regulations for this contest are included in the entry blank along with helpful hints on selenium diode applications.

JUDGES—Dr. Lee de Forest—United Engineering Labs., Los Angeles, California. J. T. Cataldo, F. W. Parrish—International Rectifier Corp.

SAMPLE ENTRY ↓
—APPLICATION—

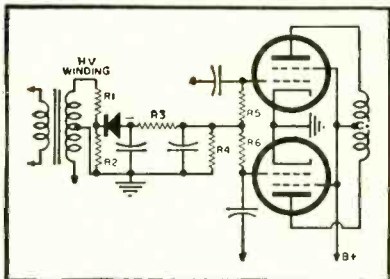

—EXPLANATION—

Typical application for providing fixed bias for push-pull stage of an audio system using International Rectifier Corp. Selenium Diode in conjunction with a voltage divider and filter network... etc.,... etc.

**DON'T DELAY! ENTRY BLANKS ARE
AVAILABLE FROM YOUR
PARTS DISTRIBUTOR
CONTEST ENDS JANUARY 1ST, 1955
INTERNATIONAL RECTIFIER CORP.
EL SEGUNDO, CALIFORNIA**

Granco Products, Long Island City, N. Y., opened a new annex adjoining its present plant.

Pioneer Electronics Corp., Los Angeles, completed a 5,000 square foot addition to its present plant. The added space will be used for warehousing picture tubes.

Wheatland Tube Co. has begun production of electric-welded steel tubing in its new mill in Delair, N. J. The company's home plant is located in Wheatland, Pa., with executive offices in Philadelphia.

National Cash Register Co., Hawthorne, Calif., established its subsidiary, Computer Research Corp. of California, as the Electronics Division of NCR. The new division will manufacture electronic computers for business application in addition to its present line of computers.

Elco Corp. moved to larger quarters at M Street, south of Erie Ave., Philadelphia.

Business Briefs

... Paramount Pictures' Barney Balaban predicted the sale of 21- and 24-inch color TV sets for about \$500 before the end of next year. Paramount owns 50% of Chromatic Television Laboratories which developed the Lawrence color TV tube.

... Technical Appliance Corp., Sherburne, N. Y., awarded its 1954 Taco Scholarship, worth \$2,500, to Wayne F. Wales, a graduate of Sherburne High School. The company awards the scholarship annually to foster an interest in technical education among local high school students.

... RETMA announced that the admission of seven new members to the association had brought total membership to a new high of 387. New members include: Allied Research & Engineering, Inc., Hollywood, Calif.; Crescent Industries, Inc., Chicago, Ill.; D & M Products, Detroit, Mich.; International Electronic Industries, Inc., Nashville, Tenn.; Morhan Exporting Corp., New York; Pan-Electronics Corp., Atlanta, Ga.; Sylvan Ginsbury, New York.

Pyramid Electric Co., North Bergen, N. J., announced that its recent offer of 92,000 shares of common stock had been completely sold out.

... RCA Tube Division, Harrison, N. J., is now producing and marketing commercial ferrite cores for use in standard components and to manufacturers' specifications.

... Radion Corp., Chicago, recently won a decision in the U.S. District Court of the Southern District of California which upheld the patent covering its "Bullseye" antenna. Defendants in the case were Pacific Bolt Corp. and Central Industries Corp.

... Radio Receptor Co., New York City, changed the name of its Seletron and Germanium Division to Semi-conductor Division to better identify products manufactured by the division under its recent expansion program. END



SH!

**LIKE
NEW!**



QUIETROLE

Reg. U. S. Pat. Off.

**The ORIGINAL
NON-INFLAMMABLE
NON-CONDUCTIVE
LUBRICANT CLEANER**

CONTROLS & SWITCHES like new by the BASKETFUL for only a few PENNIES . . . that's what QUIETROLE can do for you, and only QUIETROLE will give that long lasting smooth, quiet operation . . . even



new controls last longer and operate quieter when treated with QUIETROLE . . . the original and most reliable product of its kind.

**THE CHOICE OF
BETTER SERVICEMEN
"EVERYWHERE"**

Supplied in 2, 4, and 8 oz. sizes. Ask for it at your distributor.



manufactured by

**QUIETROLE
COMPANY**

Spartanburg, South Carolina

A New Champion!

tops in the
field of
molded tubular
capacitors



- * Outperforms all other molded tubulars in humidity tests!
- * Stands up under temperatures up to 100°C.
- * You get more for your dollar with this premium tubular designed and built especially for replacement needs, with "better-than-the-original" performance!

* Ask your C-D jobber about the special "Cub-Kit"!

* * * *

For the name of your C-D distributor, see the yellow pages of your classified phone book. Write for Catalog to: Dept. RC-954, Cornell-Dubilier Electric Corp., South Plainfield, N. J.

CONSISTENTLY DEPENDABLE
CORNELL-DUBILIER

There are more C-D capacitors in use today than any other make.

PLANTS IN SOUTH PLAINFIELD, NEW JERSEY; NEW BEDFORD, WORCESTER AND CAMBRIDGE, MASSACHUSETTS; PROVIDENCE AND HOPE VALLEY, RHODE ISLAND; INDIANAPOLIS, INDIANA; SANFORD AND FUGUAY SPRINGS, NORTH CAROLINA. SUBSIDIARY RADIART CORPORATION, CLEVELAND, OHIO



NEW! Two Probes in One

IT'S A DIRECT PROBE! FLIP THE SWITCH—IT'S AN ALIGNMENT PROBE!



Here's a versatile, low-cost probe. As a direct probe, excellent for general troubleshooting. Well shielded to avoid pickup of stray fields; minimum circuit loading. In visual alignment, where a filter characteristic is required, flip the switch—it's a resistive isolating probe. Works efficiently with any oscilloscope. Complete with calibrated coaxial cable which can be used with all Scala probes.

BZ-5 DUAL PURPOSE PROBE.....\$6.90

AVAILABLE AT LEADING JOBBERS

Scala

RADIO COMPANY

2814—19th St., SAN FRANCISCO, 10

PEOPLE

S. A. Loeb, former chairman of the Board of Webster Electric Co., Racine, Wis., was elected to chairman of the Executive Committee. Arthur C. Kleckner, formerly president, succeeds him



P. Crewe



A. C. Kleckner

as chairman of the Board. Preston Crewe, formerly executive vice-president and treasurer, was elected president and treasurer. David J. Munroe, former vice-president, Manufacturing and Engineering, is now executive vice-president. The following officers were re-elected: Frederic A. Fishel, vice-president and secretary; B. T. Wiechers, vice-president in charge of industrial sales; P. A. Karll, vice-president in charge of purchasing; Joseph O. Mitthus, assistant treasurer, and Elliott M. Ray, assistant secretary.

Leslie A. Johnson was recently elected vice-president of Cornell - Dubilier and appointed as manager of the new Sanford, N. C., plant. He has been with Cornell-Dubilier since 1939.



L. A. Johnson



G. L. Werner

G. Leonard Werner joined Astatic Corp., Conneaut, Ohio, as general sales manager. Werner was formerly sales manager of Mark Simpson Manufacturing Co.

Dr. Rodolfe M. Soria was promoted to director of engineering of American Phenolic Corp., Chicago. He was formerly head of the Development Division of the company. In his new position he succeeds Richard M. Purinton, who recently resigned as vice-president of American Phenolic and is now representing it in the New England area.



Dr. R. M. Soria



James O. Burke

James O. Burke was elected executive vice-president of Standard Coil Products, Chicago. Jere H. Cavanaugh joined Standard Coil as financial administrator. James Burke, one

Save 
Alignment Time
 with the **EAZY** to use
Align-O-Pak
 TV alignment Bias
 Battery Eliminator



★ Quickly determines
 AGC troubles

Think of the time wasted
 connecting batteries in series...
 The *Align-O-Pak* provides all
 the voltages recommended by
 these leading TV manufacturers:

- ADMIRAL 1½-4½v
- MOTOROLA 3v • PHILCO 7½v
- RCA 1v • ZENITH 2v Variable.

- ★ Forget messy Bias Batteries
- ★ Fix only TWO AGC troubles and your *Align-O-Pak* is paid for
- ★ Just Plug it in...
- ★ Provides from 0 to 10 Volts BIAS Instantly
- ★ Completely isolated from Power Line and Case

Only
7.85
 DEALER NET

INSTRUCTIONS

FOR ALIGNMENT: Plug *Align-O-Pak* in and turn unit on. Connect black lead to the Receiver AGC buss and red lead to B minus (usually chassis). Set *Align-O-Pak* knob to voltage recommended by TV manufacturer.

FOR AGC TROUBLE SHOOTING: With *Align-O-Pak* connected as described above, turn control knob slowly from 0 to 10. If normal picture appears, AGC is defective.

Carried by leading jobbers!

SI SERVICE INSTRUMENTS COMPANY
 422 South Dearborn Street, Chicago 5, Illinois

PEOPLE

of the founders of Standard Coil, is also treasurer and director of the company.

Albert Brand, secretary-treasurer of Radio Merchandise Sales Corp., New York City, now also assumes the responsibilities of sales manager for the company. Mr. Brand together with Sidney Pariser are the founders of the company.



Albert Brand

S. John La Puma joined JFD Manufacturing Co., Brooklyn, N. Y., as publicity director for all the firm's divisions. He has had wide public relations experience with the U. S. Army overseas and was formerly a copywriter with a New York advertising agency.



S. J. La Puma

Jerry Kirshbaum of Precision Apparatus Co., was re-elected president of the Eastern Division of the Sales Managers' Club. Robert Ferree, International Resistance Co., was re-elected vice-president. Walter Jablon, of Freed-Eisemann Radio Co., was elected to the Board of Directors of the Show Corporation for a period of two years.



J. Kirshbaum

Obituary

David Turner, chairman of the Board, and one of the founders of the Turner Company, Cedar Rapids, Iowa, died recently of a heart ailment. Quintin G. Noblitt, co-founder and chairman of the Board of Arvin Industries, Columbus, Ind., died in the Bartholomew County Hospital at the age of 71.

Personnel Notes

... Max F. Baleom, director-consultant of Sylvania Electric Products, was elected chairman of the RETMA Board of Directors. Glen McDaniel was re-elected president and general counsel. ... David H. Newton was appointed advertising manager of Telex, Inc., St. Paul, Minn., for both its electro-acoustic and its hearing aid divisions. ... Ray L. Triplett, founder of Triplett Electrical Instrument Co., Bluffton, Ohio, was honored by local citizens and sales representatives from 24 states and 6 foreign countries at a community celebration of his 50th anniversary in the industry. ... Don Larson, advertising director of Hoffman Radio Corp., was appointed general manager of the West Coast Electronic Manufacturers' Association.

Color Servicing
 IS NOW IN THE FAMOUS
Mandl's TV Servicing



A MASTER HANDBOOK FOR ANY SERVICE JOB
A COMPLETE COURSE IN TV SERVICING

The new section on color servicing and color circuits gives you the same clear how-to-do-it instruction that has made this book a favorite with servicemen everywhere. You'll be FULLY prepared to service any set, do the best job of installation or trouble shooting in minimum time, either for color or for black and white.

EASY to learn

Simple, clear explanations show you how each unit in the TV receiver functions, with lists of the flaws that may occur in it, what points in the circuitry cause them, how they affect other components, how they show up on the TV screen. Every step is fully illustrated with large clear schematics, photographs of test patterns, scope patterns and other helpful illustrations.

How to locate trouble quickly

A complete master trouble index gives the possible causes of distortions or faults in picture or sound, with references to the pages on which servicing instructions are given. You can quickly and easily diagnose the source of trouble and know just what to do about it.

Methods used by experts

You'll learn the practical time-saving methods used by the most experienced servicemen and technicians:—ways of locating those hard-to-find troubles, simple signal tracing procedures, how to improve reception in fringe areas, how best to use test equipment. You'll learn the necessary why's and wherefore's of TV reception, but won't be confused by unnecessary theory or involved math—just what you need in order to do a skilled servicing job is given here.

Recent improvements

In addition to the instruction on color—how it works, how to service color sets—you'll have the latest data on such improvements as cascade tuners, automatically focused tubes, new types of high frequency I.F. systems, transistors, UHF-VHF receivers. You'll learn TV for today and TOMORROW from this book.

Look it over without obligation. See for yourself how easy and practical this book is—how quickly you'll become expert with it, how useful it is on any job. Get a copy on

10-day FREE TRIAL

THE MACMILLAN COMPANY,
 Dept. RE-5
 60 Fifth Avenue • New York 11

Please send me a copy of the new Mandl's TV Servicing. I will either pay the full price of \$5.75 plus a small delivery charge or return the book in 10 days. (SAVE: send check or money order and we pay delivery charge.)

Signed _____
 Address _____

This offer good only within continental limits of U.S.A.

FOR THE FINEST SOUND SYSTEMS

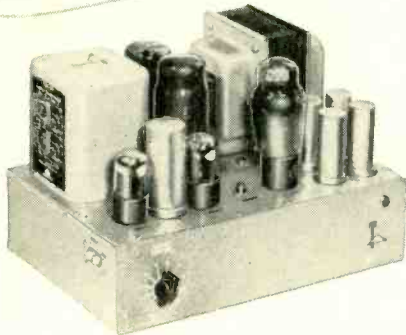

TRIAD High Fidelity Amplifier Kits

A home music system which will meet true high fidelity standards must necessarily be composed of the very finest components—pickups, turntables, amplifiers, speakers, enclosures.

In this group of components Triad offers High Fidelity Amplifier Kits—built by men with a brilliant background in producing America's finest transformers. Engineered to produce maximum frequency range with minimum distortion, these "do-it-yourself" kits afford obvious economies over complete units—which permits upgrading of other components in the system.

Triad High Fidelity Amplifier Kits include all necessary transformers and chokes, punched sectional aluminum chassis and complete assembly instructions.

In quality and performance they are fitting companions to the finest sound system components available today.

HF-3 Kit: Preamplifier. Adequate gain to drive an HF-40 or HF-18 from any commercial pickup or microphone. D.C. filament supply. Complete record compensation and new tone control circuits. List Price—\$32.80.

HF-12 Kit: 10-watt power amplifier. Replaces HF-10. Built-in preamp to accommodate all crystal and magnetic cartridges. Complete record compensation and new tone control circuits. Output impedances 4-8-16 ohms or 125-250-500 ohms. List Prices from—\$50.40.

HF-18 Kit: "Williamson" type all-triode amplifier. Full power output of 16.2 watts for triode operation or 20 watts for pentode operation from 12 to 60,000 cycles. Frequency response within 0.2 db from 7 to 80 kc. Output impedances 4-8-16 ohms or 125-250-500 ohms. List prices from—\$63.65.

HF-40 Kit: Features a full 40-watt amplifier from 20 to 40,000 cycles, using regulated screen voltage and fixed bias on two 6146 output tubes. Output impedances 4-8-16 ohms or 125-250-500 ohms. List from—\$78.35.



Write for
Catalog
TR-54B



4055 Redwood Ave. • Venice, Calif.

PEOPLE

... Frank M. Folsom, president of RCA, presented President's Cup awards to five branch managers of the RCA Service Company who were winners in a recent campaign to promote efficiency and customer satisfaction in TV servicing. Winners were Orval H. Bowers, Flushing, N. Y.; William L. Davis, Indianapolis; James K. Stewart, Salt Lake City; Lawrence E. Traeger, Spokane; Acie C. Criss, Montgomery, Ala.

... Harry L. Chaney joined Kay-Townes Antenna Company, Rome, Ga., as chief engineer. He was formerly with Tele-King and Electronic Devices Company.

... Edward C. Tudor, president of I.D.E.A., Inc., was named chairman of the RETMA Credit Committee.

... Earl F. Larson was named sales application engineer for the Westinghouse Electric Corporations' South Pacific District with headquarters in Los Angeles. Robert E. Thomas was promoted to sales application engineer for the Central Pacific District with headquarters in San Francisco. Maurice Birt was named manager of customer service and tube warehousing. The new appointments are in line with a company move to expand its Western sales, service, and warehouse facilities for tubes. Westinghouse also established a new regional headquarters office in Los Angeles.

... John L. Franke was appointed chief engineer of the RCA Victor Radio and Victrola Engineering Department, Camden, N. J. Alexander D. Burt was promoted to manager of record changer engineering and Paul R. Bennett to manager of radio and phonograph engineering. All three were formerly staff engineers of the RCA Home Instrument Division.

... Frank W. Edmonds joined Burnell & Co. as president of the newly formed Pacific Division in South Pasadena, Calif. He was formerly with Langevin Manufacturing Company.

... Arthur C. Bryan was appointed vice-president and general manager of Consumer Products, and William H. Feathers was appointed vice-president and general manager of Industrial Products of National Carbon Company, a division of Union Carbide and Carbon, New York City. Walter A. Steiner was appointed vice-president in charge of development. All have been with the company for some time.

... Joseph P. Gavron, a 22-year veteran with Mycalex Corp., New York City, was named assistant to the president, Jerome Taishoff.

... Edward F. Morgan and Vernon L. Brown, Jr., were named service managers of the New York and Chicago districts, respectively, of Magnavox Corp., Fort Wayne, Ind. Both are veterans in servicing work. Morgan replaces R. J. Guilfoyle who was named district manager of the Harrisburg territory, and Brown takes the place of R. J. Weber who was promoted to the company's Advertising Division as sales training manager. **END**

CLOSE OUT!

**WORLD-FAMOUS
HI-FI 3-SPEED
AUTOMATIC PHONO
3 SPEAKERS**

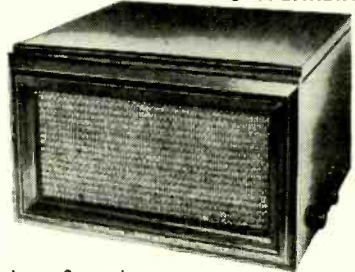

Deluxe 3-speed automatic record player with speaker cross over network for true high-fidelity. 4 tube amplifier scientifically designed to reproduce from 20 to 20,000 cycles. Automatic shut-off for amplifier when last record has played. Beautiful mahogany cabinet with luxurious woven grill. Dimensions: 17 7/8" x 15 7/8" x 11". Weight 30 lbs.

**Nationally
Advertised
for \$139.95**

**CLOSE OUT
PRICE!**

\$72⁵⁰

Write Dpt. RE-9 for FREE catalog.

STEVE-EL Electronics Corp.
61 Reade St. New York 7, N. Y.

OSCIL-O-PEN

Extremely convenient test oscillator for all radio servicing; alignment • Small as a pen • Self powered • Range from 700 cycles audio to over 600 megacycles u.h.f. • Output from zero to 125 v. • Low in cost • Used by Signal Corps. • Write for information.

GENERAL TEST EQUIPMENT
38 Argyle Ave. Buffalo 9, N. Y.



**NOW
COYNE**
TRAINS YOU
IN SPARE TIME
AT HOME

TELEVISION RADIO-ELECTRONICS

Only from famous COYNE do you get this modern up-to-the minute TV Home Training. Easy to follow, Step-by-Step instructions—fully illustrated with 2150 photos and diagrams. Not an old Radio Course with Television tacked on. Personal guidance by Coyne Staff. So practical you can quickly **EARN MONEY** in a TV-RADIO SALES and SERVICE BUSINESS—part time or full time. Not only FINEST TRAINING but COSTS MUCH LESS—pay only for training—no costly extras.

SEND COUPON FOR DETAILS FREE
SEND COUPON BELOW for Picture Folder and full details including EASY PAYMENT PLAN. NO COST OR OBLIGATION—NO SALESMAN WILL CALL.

B. W. COOKE, Pres.

COYNE
ELECTRICAL SCHOOL

FOUNDED 1899

A TECHNICAL TRADE INSTITUTE CHARTERED NOT FOR PROFIT
500 S. Paulina Dept. 64-HT4 Chicago 12, Illinois

B. W. COOKE, President
COYNE ELECTRICAL SCHOOL
500 S. Paulina St., Chicago 12, Ill. Dept. 64-HT4
Send FREE Picture Folder and details of your Television-Radio-Electronics Home Training offer.

Name _____
Address _____
City _____ State _____

RADIO-ELECTRONICS

Any or all of these catalogs, bulletins, or periodicals are available to you on request direct to the manufacturers, whose addresses are listed at the end of each item. Use your letter-head—do not use postcards. To facilitate identification, mention the issue and page of RADIO-ELECTRONICS on which the item appears. All literature offers void after six months.

PRINTED CIRCUITS

Photocircuits Corp. has issued an 8-page engineering brochure on printed circuits describing their function, fabrication, and application. Information on methods of application, materials, electrical characteristics and components. Assembly with dip soldering and plate-through holes is described.

Available gratis from Photocircuits Corp., Glen Cove, N. Y.

SOUND EQUIPMENT

David Bogen Co., Inc., has issued a 20-page catalog, No. PA554, on public address amplifiers, sound systems, and sound accessories. One section of the catalog, entitled "Hints for Selecting the Proper Sound System," discusses the important factors involved in determining what equipment to use.

Characteristics for the new Bogen J series of PA amplifiers are given. The catalog lists sound systems for permanent installations, both inside and outdoors, as well as portable systems. It also lists the following accessories: microphones, stands, cone speakers, trumpet speakers, wall baffles, line-to-speaker matching transformers, recessed baffles, rack mountings, and vibration isolating bases. Also included are portable phonograph units, transcription players, high-power paging systems and a music-instrument amplifier.

Available from Bogen distributors and from David Bogen Co., Inc., 29 Ninth Ave., New York 14, N. Y.

APPLICATION GUIDE

Yardney Electric has issued a Silvercel application guide which gives complete electrical data and physical dimensions of more than 24 batteries. The device serves as a handy indicator for the selection of the most suitable battery for any requirement.

Gratis from Yardney Electric Corp., 105 Chambers St., New York, N.Y.

RESISTORS

Tru-Ohm Products has issued a 20-page catalog on resistors and power rheostats. All pertinent information on fixed, adjustable, axial lead, heavy duty, and other resistors is given. Special size resistors are illustrated, as are resistor mountings.

A section of the catalog is devoted to power rheostats—25, 50, 75, 100, and 150 watts. The information also includes data on special rheostat shaft and bushing assemblies, taper wound rheostats, tandem rheostat assemblies, etc., and ceramic welding nozzles.

Gratis from Tru-Ohm Products, 2800 N. Milwaukee Ave., Chicago 18, Ill.

RESISTORS

IRC has issued an 8-page catalog data bulletin, G-1, on the type MV high-voltage resistors. Forty-five different types of resistors are described, giving their characteristics, construction, individual specifications, applications, and installation. The catalog is well illustrated with charts, graphs, and photographs.

Available upon writing to International Resistance Co., 401 N. Broad St., Philadelphia 8, Pennsylvania.

CRYSTAL CATALOG

Standard Crystal Co., has issued a 12-page catalog, No. 354 on crystals. It features their complete line from subminiature hermetically-sealed plated units to crystal ovens. A military chart is included as an aid in selecting proper crystal types for particular requirements.

Available by writing Standard Crystal Co., 1714 Locust, Kansas City, Missouri.

ALIGNMENT TOOLS

General Cement Manufacturing Co. has issued a 4-page color brochure, No. 3545 which features 36 TV alignment tools plus five tool kits containing matched sets of tools, suitable for a wide range of receivers.

Available gratis from General Cement Manufacturing Co., 919 Taylor Avenue, Rockford, Illinois.

TEST EQUIPMENT

EICO has issued a 6-page brochure, form DMC-554, which gives the specifications of 38 kits, as well as 42 factory-wired instruments.

Available gratis from EICO distributors or direct from the Electronic Instrument Co., Inc., 84 Withers St., Brooklyn 11, N. Y.

SKETCHBOOK

G. H. Leland, Inc., has issued the Engineering Ledex Sketchbook bulletins which will be put out approximately once a month. Application notes, specifications, typical circuits, and other pertinent data on the Ledex line of rotary solenoids, circuit selectors and relays are given in the various issues of the Sketchbook.

Available to engineers from G. H. Leland, Inc., Dayton 2, Ohio.

REFERENCE CAVITIES

General Electric has issued a 12-page booklet which describes types GL-1Q26-A, GL-6301, and GL-6452 reference cavities for frequency determination in micro wave circuits.

Available to interested parties from the Tube Department, General Electric, Schenectady 5, N. Y.

TV FUSE LIST

Bussmann Manufacturing has issued a 1954 TV fuse list. Information on fuses used in past and present TV sets are given. Pictures and dimensions of various types of fuses are listed.

Available from Bussmann Manufacturing Co., University at Jefferson, St. Louis 7, Missouri. END



XCELITE Hand Tools
PREFERRED BY THE EXPERTS

**Yes—There IS such
A THING AS TOP VALUE!**

IT'S YOURS IN XCELITE PLIERS

By "value", we mean high grade tool steel drop forged electronic pliers. We mean induction hardened, hand-honed blades that cut clean and stay sharp. We mean the same accurate workmanship you find in XCELITE screwdrivers and nut drivers. And by VALUE we mean list prices of only \$2.90 for our No. 59 Needle Nose Assembly Plier—\$3.10 for 5" diagonal—\$2.70 for 6" side cutter—many others. Ask your supplier for bargains like this!



5" DIAGONAL
PLIER
\$2.70
list



RADIO-TV
PLIER
Only
\$3.70
list

XCELITE, INCORPORATED
(Formerly Park Metalware Co., Inc.)
Dept. J Orchard Park, N. Y.



When answering advertisements please mention
RADIO-ELECTRONICS

VIDEO TUBES

ELECTRIC COMPANY

AT WHOLESALE

★ 100% GUARANTEED ★

BRANDED!	★	SAME DAY SERVICE!
1A4P	.29	6BD5 .59
1A7	.49	6BE6 .39
1B3	.59	6BG6 .99
1B4P	.79	6BH6 .49
1C6	.29	6BJ6 .49
1C7	.29	6BK7 .69
1E7GT	.39	6BL7 .69
1F5G	.29	6BN6 .99
1H5	.49	6BQ6 .79
1L4	.49	6BQ7 .79
1L6	.59	6BY5G .59
1LA6	.39	6BZ7 .79
1LC5	.39	6C4 .39
1LC6	.39	6CB6 .49
1N5	.49	6CD6 .99
1R5	.49	6CU6GT .99
1S5	.39	6F6 .39
1T4	.49	6F7 .69
1T5GT	.69	6J6 .59
1U4	.49	6J8 .79
1U5	.39	6K6 .39
1X2	.59	6L6 .69
2A3	.29	6N6 .69
2A7	.29	6S4 .39
3AGT	.99	6S8 .59
3Q4	.49	6SA7 .49
3Q5	.59	6SD7 .49
3S4	.49	6SK7 .49
3V4	.49	6SL7 .59
5U4	.39	6SN7 .59
5V4	.49	6SQ7 .39
5Y3	.29	6SR7 .49
5Y4	.49	6T8 .69
5Z3	.29	6U8 .69
6AB4	.39	6V6 .49
6AG5	.49	6W4GT .39
6AJ5	.69	6X4 .29
6AK5	.69	6X5 .29
6AL5	.39	7A4, XXL .39
6AQ5	.49	7A6 .49
6AS5	.49	7A7 .49
6AT6	.39	7A8 .49
6AU6	.39	7AK7 .79
6AV6	.39	7B4 .49
6B7	.79	7B5 .49
6BA6	.49	7B6 .49
6BA7	.59	7B7 .49
6BC5	.49	7F7 .59
		7F8 .59
		7J7 .59
		7K7 .59
		7U5 .49
		7Z4 .39
		12AL5 .39
		12AT6 .39
		12AT7 .69
		12AU6 .39
		12AU7 .59
		12AV6 .39
		12AV7 .69
		12AX7 .59
		12BA6 .39
		12BA7 .59
		12BE6 .39
		12BH7 .59
		12SA7 .49
		12SK7 .49
		12SN7 .59
		12SL7 .59
		12SQ7 .39
		14S7 .79
		19BG6 .99
		19T8 .69
		25BQ6 .79
		25L6GT .39
		25W4GT .39
		25Z6 .39
		35B5 .39
		35C5 .39
		35W4 .29
		35Z3 .29
		35Z5 .29
		35/51 .29
		36 .29
		37 .29
		39/44 .29
		49 .29
		50B5 .49
		50C5 .49
		50L6 .49
		75 .29
		76 .29
		77 .29
		80 .29
		117L7GT .99
		117Z3 .29

Surprise Package of Radio & TV Parts

3 lbs. of parts including resistors, controls, coils, IF cans, etc. Easily worth \$10.00

\$1.95

FREE! with every order of \$20 or more—famous "Oxwall" magnetic screw driver kit. Includes all sizes—Phillips head, long handles to get in those tight spots, etc. 7 screwdrivers in all. May be purchased outright. List value \$4.89 \$1.99 each; 3 for \$5.50.

MINIMUM ORDER \$7.00

25% deposit with order. Balance COD. If full remittance is sent, please include postage. Excess money will be refunded. We have more than 250 types in stock at all times. Order your other needs at similar savings or write for quotations. Quantity users—write for special discounts!

VIDEO ELECTRIC COMPANY
79 CLINTON PLACE
NEWARK, N. J.

Master the scope

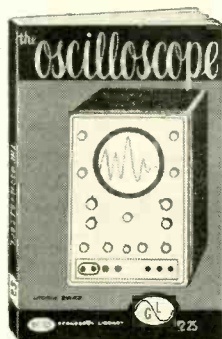

THE OSCILLOSCOPE. By George Zwick. Gernsback Library Book No. 52. 192 Pages. Over 100 illustrations. **Only \$2.25.**

THE OSCILLOSCOPE is first of all a practical instruction book on how to use the scope properly. Of course, the author tells you what goes on behind the cathode-ray tube, but when you've got that down, he really rolls up his sleeves and gives you full details on how to use the scope to best advantage in all types of servicing and how to understand everything you read on the face of the tube. Moreover, he warns you about the pitfalls of using the scope improperly and tells you how to avoid them.

WRITTEN FOR ON-THE-BENCH USE

This isn't a book you'll read, digest and forget about. The author—a teacher and engineer, gives you the kind of tips you need when working on some of the "dogs" likely to cross your bench today. This is a book you'll keep open on the bench as you work along with the set and the scope—and the more you use it and read it, the more you'll profit from it. THE OSCILLOSCOPE is the biggest Gernsback Library Book yet published. Look at this partial list of contents. Check all the information it packs into its 192 pages. Where else could you get so much information on oscilloscopes for such a low price! This book belongs on every service technician's work bench. Order your copy today and start now to cash in on the added knowledge this book will bring you.

Other Gernsback Library Books you'll want to read.

- Transistors—Theory and Practice. No. 51—\$2.00
- TV Repair Techniques. No. 50—\$1.50
- Radio & TV Test Instruments. No. 49—\$1.50
- High-Fidelity—Design, Construction, Measurements. No. 48—\$1.50
- Radio & TV Hints. No. 47—\$1.00
- Television Technotes. No. 46—\$1.50
- Radio Tube Fundamentals. No. 45—\$1.00
- Basic Radio Course. No. 44 (Cloth Bound)—\$2.25
- Model Control By Radio. No. 43—\$1.00
- High-Fidelity Techniques. No. 42—\$1.00
- Public-Address Guide. No. 41—75c
- Practical Disc Recording. No. 39—75c

When you really understand how the oscilloscope works and all the things it can do, you'll get lots more use out of it. It will help you do a better job faster—and in the long run, earn more money. This big new GERNSBACK LIBRARY BOOK is a practical guide on how to get the most out of the scope.

Partial List of Contents of THE OSCILLOSCOPE

CHAPTER 1—WAVEFORMS

Direct current • Alternating current • Alternating current cycle • Sine waves • The sawtooth • Square waves • Trapezoidal waves • Comparison between waveforms.

CHAPTER 2—THE CATHODE-RAY TUBE

Structure • The electron gun • Grids • Anodes • Cross-over point • Deflection system • Time bases • Linear and non-linear sweep • The fluorescent screen • The phosphor.

CHAPTER 3—SWEEP SYSTEMS

Flyback time • horizontal deflection voltage • Sawtooth generators • Relaxation oscillator • Firing voltage • Sawtooth frequency • Frequency control • Synchronization • Marker signals • Retrace blanking.

CHAPTER 4—TYPICAL OSCILLOSCOPES

Circuit analysis of the Du Mont 208B and the RCA WO-56A.

CHAPTER 5—ALIGNMENT

Meaning of Bandpass • Alignment of peak-tuned i.f. system • Broad-band alignment • The FM discriminator • The ratio detector • Video i.f. channels • I.f. alignment procedure •

Quick alignment check • TV sound i.f. channels • Front-end alignment • Oscillator alignment using stations • Video-output response.

CHAPTER 6—OSCILLOSCOPE TECHNIQUES

Matching pad balanced to ground • Scope probes • The r.f. probe • Isolation of instrument from equipment under test • Coupling to the front end • Measuring low input voltages • A.g.c. bias substitute • Calibration of scope as a voltmeter • Plotting curves • Scope precautions.

CHAPTER 7—TESTS AND MEASUREMENTS

Audio-gain measurements • Audio response • Phase shift • Hum • Video flutter • Measurement of current waveshapes • Auto-radio vibrator supplies • Selenium rectifiers • Checking filter operation • Measuring ripple.

CHAPTER 8—EXPERIMENTS USING THE OSCILLOSCOPE

Adjustment of controls • Direct and amplified signals • Lissajous figures • Audio distortion • Modulation envelope • Square wave testing • Meter behavior on pulse voltages • Capacitor leakage measurements.

From the publishers of **RADIO-ELECTRONICS**

See your distributor—or mail this coupon

GERNSBACK PUBLICATIONS, INC., Dept. 94
25 West Broadway
New York 7, N.Y.

Enclosed is my remittance of \$.....
Please send me the following books postpaid.

- 52 THE OSCILLOSCOPE \$2.25
 39 41 42 43 44 45
 46 47 48 49 50 51

Name.....
(Please print clearly)

Street.....

City..... Zone..... State.....

RADIO SCHOOL DIRECTORY

TELEVISION

PREPARE FOR A GOOD JOB!

BROADCAST ENGINEER
ELECTRONICS
RADIO SERVICING

Television Servicing

(Approved for Veterans)

SEND FOR FREE LITERATURE

BALTIMORE TECHNICAL INSTITUTE
1425 EUTAW PLACE, BALTIMORE 17, MD.

Get Your F.C.C. LICENSE Quickly!

Correspondence or residence preparation for F.C.C. examinations. Results guaranteed.

An FCC commercial operator license means greater opportunities and higher pay. We are specialists in preparing you, in a MINIMUM OF TIME, to pass FCC examinations for all classes of licenses. Beginners get 2nd class license in 5 weeks and 1st class in 3 additional weeks. Write for free booklet.

GRANTHAM School of Electronics
Dept. 101, 6064 Hollywood Blvd., Hollywood 28, Calif.

GET INTO ELECTRONICS

You can enter this uncrowded, interesting field. Defense expansion, new developments demand trained specialists. Study all phases radio & electronics theory and practice: TV; FM; broadcasting; servicing; aviation, marine, police radio. 18-month course. Graduates in demand by major companies. H.S. or equivalent required. Begin Jan., March, June, Sept. Campus life. Write for catalog.

VALPARAISO TECHNICAL INSTITUTE
Dept. C Valparaiso, Ind.

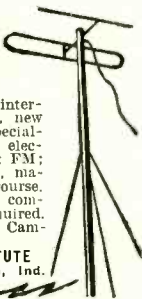

TV REPAIRMEN EARN TOP MONEY!



IN JUST 12 MONTHS, COMPLETE TV SERVICE TRAINING, INCLUDING COLOR TV. Streamlined course gives you all essentials for a good job as service technician. Graduates in great demand; jobs are plentiful in this growing field. Other electronic courses in radio operation and maintenance. Day or evening classes. Opportunity for employment in local industry. Approved for Korean veterans.

Write for Catalog 111 Today

INDIANAPOLIS ELECTRONIC SCHOOL
312 E. Washington, Indianapolis 4, Ind.

LEARN TV AT HOME

Here is your opportunity to learn TV servicing at home... a simple 14-week course written so you can understand it, priced so you can afford it.

This well-established, reputable TV and electronics school will send you complete lessons, tests and give you individual consultation, by correspondence.

The complete course costs only \$25.00. This is a limited offer so write today for information to:

VIDEO SPECIALTIES, INC., Dept. 616A
4508 E. Firestone Blvd., South Gate, Calif.

RADIO-TV ELECTRONICS



CREI graduates in big demand. Accredited by Engineers Council for Professional Development. New classes start every month. Free placement service for grads. Courses offered—Radio Engineering, Broadcast or TV Engineering, TV, FM, AM Servicing. Write for free catalog. Approved for Vets.

CAPITOL RADIO ENGINEERING INSTITUTE
Dept. RE, 3224—16th St., N.W., Washington 10, D. C.

MORE JOBS

than graduates

Demand for our engineering graduates exceeds supply. *Effective placement.* Study in this world-famed college established 1884. Quarters start September, January, March, June. *Approved for Korean Vets.*

Bach. Sc. degree in 27 months

Complete Radio Eng. courses... TV, UHF and FM. Also Mech., Civil, Elec., Chem., Aero. and Adm. Eng.; Bus. Adm., Acct. Small classes. Well-equipped labs. Modest costs. Prep. courses. Write *Jean McCarthy, Director of Admissions, for Catalog and Campus View Book.*



TRI-STATE COLLEGE

2494 College Avenue, Angola, Indiana

RADIO ENGINEERING DEGREE IN 27 MONTHS

Intensive, specialized course including strong basis in mathematics and electrical engineering, advanced radio theory and design, television. Modern lab. Low tuition. Self-help opportunities. Also B.S. degree in 27 months in Aeronautical, Chemical, Civil, Electrical, and Mechanical Engineering. G.I. Gov't approved. Enter September, December, March, June. Catalog.

INDIANA TECHNICAL COLLEGE

1594 E. Washington Blvd., Fort Wayne 2, Indiana



RCA INSTITUTES, INC.

A service of Radio Corporation of America
350 West 4th St., New York 14, N. Y.

OFFERS COURSES IN ALL TECHNICAL PHASES OF RADIO, TELEVISION, ELECTRONICS

Approved for Veterans

Write Dept. RE-54 for Catalog

EARN MORE MONEY— BE A PROFESSIONAL TELEVISION SERVICE TECHNICIAN

STEP INTO THE TOP PAY \$5,000—\$10,000 A YEAR CLASS. 7 MONTHS' SHOP TRAINING QUALIFIES YOU.



If you want to reach your goal as a Successful Service Technician you will need plenty of "KNOW HOW" to qualify for the better servicing jobs or profitable shop ownership.

SEND FOR FREE BOOK TODAY!

WESTERN TV offers real experience on live equipment in our BIG SHOPS AND LABORATORIES in the shortest practical time under expert instructors. Graduates are in big demand because they have the "field experience" necessary for immediate "bench" or supervisory positions. You learn every phase of Radio and TV servicing (AM, FM, VHF, UHF). WTI men win fast promotion... can demand better pay... develop highly profitable businesses of their own with the latest and most PRACTICAL PERSONALIZED TRAINING BEHIND THEM. You concentrate all your time on being a PROFESSIONAL TV SERVICE TECHNICIAN—non-essential math and engineering theory omitted. YOU CAN EARN WHILE YOU LEARN. Special Finance Plan.

APPROVED FOR VETERANS. Find out how you can get into the TOP PAY GROUP— Send for this fact-packed book NOW!

WESTERN TELEVISION INSTITUTE

America's Leading Television Servicing School

Western Television Institute Dept. E-9-4
341 W. 18th St., Los Angeles 15, Calif.
Without obligation, please send FREE fully illustrated booklet. (No salesman will call.)

NAME _____ AGE _____
ADDRESS _____
CITY _____ ZONE _____ STATE _____

Become an

ELECTRICAL ENGINEER



Major in Electronics or Power BS Degree in 36 months

Prepare now for a career as an electrical engineer or engineering technician — and take advantage of the many opportunities in these expanding fields.

You can save a year by optional year 'round study. Previous military, academic, or practical training may be evaluated for advanced credit.

Enter Radio and Television — courses 12 to 18 months

You can be a radio technician in 12 months. In an additional 6-months you can become a radio-television technician with Associate in Applied Science degree. Color television instruction is included in this program.

These technician courses may form the first third of the program leading to a degree in Electrical Engineering. Twenty-one subjects in electronics, electronic engineering and electronic design are included in these courses.

Courses also offered: radio-television service (12 mos.); electrical service (6 mos.); general preparatory (3 mos.).

Terms — September, January, April, July

Faculty of specialists. 50,000 former students—annual enrolment from 48 states, 23 foreign countries. Non-profit institution. 51st year. Courses approved for veterans. Residence courses only.

MS-6A

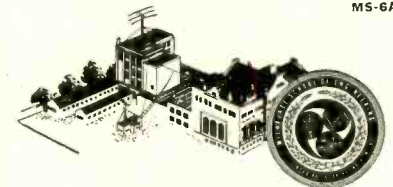

MILWAUKEE SCHOOL OF ENGINEERING

MILWAUKEE SCHOOL OF ENGINEERING
Dept. RE-954, 1025 N. Milwaukee Street
Milwaukee 1, Wisconsin

Send FREE illustrated booklets
 Career in Electrical Engineering.
 Career in Radio-Television.

I am interested in _____ (name of course)

Name _____ Age _____

Address _____

City _____ Zone _____ State _____

If veteran, indicate date of discharge _____

A Star Is Born...

Only EICO #232 Peak-to-Peak VTVM has all these Advanced Features ★

★ FOR THE FIRST TIME ALL CALIBRATION IS DONE WITH INSTRUMENT IN CABINET.

★ 7 non-skip ranges on every function — DC/RMS sine volts: 0-1.5, 5, 15, 50, 150, 500, 1500. (To 30 kv with HVP probe.) Res.: 0.2 ohms to 1000 megs.—Uniform 3 to 1 scale ratio assures extreme wide-range accuracy.

★ Flat freq. response 30 cps to 3 mc.

★ Measures directly peak-to-peak voltage of complex & sine waves: 0-4, 14, 42, 140, 420, 1400, 4200. Vital for TV servicing. Saves the cost of separate Peak-to-Peak Probe.

★ Modern styling, etched panel; compact, easily portable. Size: 8½" x 5" x 5".

★ Terrific time and trouble-saver! One probe for all functions—in a "twist of the wrist" it selects DC or AC (Peak-to-Peak & RMS)/OHMS!

★ No annoying lead tangle, no back-and-forth prod changing. Positive-action, rugged!

NEW PEAK-to-PEAK VTVM AT LOWEST COST

With Exclusive **Uni-Probe**



KIT \$29.95
Factory Wired \$49.95

Complete with UNI-PROBE at no extra cost

Excellent for your bench

Model 249 Peak-to-Peak VTVM with Giant 7½" Meter

KIT \$39.95 **Wired \$59.95**

Complete with UNI-PROBE



ELECTRONIC INSTRUMENT CO. INC.

84 Withers Street
Brooklyn 11, N. Y.

Prices 5% higher on West Coast. © 54

See this amazing engineering achievement at your jobber today. Write now for FREE latest catalog **CV-9**

BOOK REVIEWS

TELEVISION SIMPLIFIED, Fourth Edition, by Milton S. Kiver. Published by D. Van Nostrand Company, Inc., 250 Fourth Avenue, New York, N. Y. 6 x 9 inches, 533 pages. Price \$6.75.

Now in its fourth edition, *Television Simplified* remains an outstanding text on the basic principles of television. Containing many new illustrations and schematic diagrams in addition to new and expanded chapters on up-to-date developments, the text is never complicated, yet is remarkably complete.

Two new chapters cover u.h.f. and color television, with the chapter on u.h.f. including a thorough discussion of u.h.f. antennas, transmission lines, and converters.

Added material consists of information on TV tuners, video and cascode amplifiers, and an explanation of various keyed a.g.c. systems. A great deal of space is devoted to the inter-carrier receiver, and there is a complete analysis of two television receivers. The new 40-mc i.f. system is discussed and compared with the older 20-mc system.—JK

HOW TO LOCATE AND ELIMINATE RADIO AND TV INTERFERENCE, by Fred D. Rowe. Published by John F. Rider Publisher, Inc., 480 Canal St., New York, N. Y. 5 x 8½ inches, 122 pages (including 20-page appendix and index). Price \$1.80.

The location and elimination of interference to broadcast and communications services has always plagued engineers and service technicians. Comparatively little practical information has been published on this subject in the past, so many technicians are at a loss as to how to attack the problem. This has often led to erroneous or false diagnosis (usually with an amateur radio operator getting the blame for interference produced by a heater thermostat, electric sign, etc.).

Many cases of interference still in existence would have been cleared up long ago if this book had been published earlier and its contents digested by the technician receiving the complaint.

The book borders on the nontechnical and can be understood readily by readers with the minimum knowledge of electric or electronic circuits and devices. It opens with discussions of the general interference problem including types and sources and the methods for locating them. The author begins the section on prevention and elimination of TVI and BCI with discussions on the use of power-line filters and proper installation techniques for effective reduction of noise from neon signs, fluorescent lamps, thermostats, vibrators, motors, and other electrical apparatus, and concludes with discussions on suppressing TVI at the transmitter and eliminating it at the receiver.

There are two appendices. The first consists of 67 questions and answers based on the material covered in the text. The second is a typical radio-interference ordinance of the type enacted in many localities.—RFS

EARN Big Money!

TELEVISION ELECTRONICS RADIO-RADAR

Learn TV, Radio Servicing, Radar, Sonar, Electronics at home in your spare time by Christy Shop-Method Home Training. Covers all subjects. The *only* complete course. Repair television and radio sets of friends and neighbors. Service electronic equipment in factories, stores, hospitals. Earnings made while learning can pay for your training. **19 TRAINING INSTRUMENTS INCLUDED!** Learn by Doing. Rush name for FREE Book and FREE Sample Lessons. **CHRISTY TRADES SCHOOL**, Dept. T-106, 4804 N. Kedzie, Chicago 25.

RADIO • TELEVISION SERVICEMEN!

HERE IS YOUR 1954 OPPORTUNITY TO DEVELOP A PROFITABLE SMALL APPLIANCE REPAIR SERVICE WITH PRESENT SHOP EQUIPMENT

We supply a complete program designed to maintain you in the highly profitable traffic appliance repair field.

ELECTRIC SWEEPER SERVICE CO.

"The House of **ESSCO** 100,000 Parts"
2034 EUCLID AVE. • CLEVELAND 15, OHIO

BOOK REVIEWS

CRYSTAL HANDBOOK, compiled by the Research Division, James Knights Co., Sandwich, Ill., 35 pages, \$1.00.

A short treatise dealing with piezo-electric effects, crystal cuts, crystal oscillators and applications. A large number of circuit drawings and a short bibliography.

THEORY AND DESIGN OF ELECTRON BEAMS, by J. R. Pierce. D. Van Nostrand, New York. 222 pages, \$4.50.

A work on electron optics written by the Research Director of Bell Telephone Laboratories. The author has gathered together "the minimum amount of theoretical material necessary for a good understanding of electron flow and electron focusing in devices other than electron microscopes and image tubes."

SCIENCE AND THE COMMON UNDERSTANDING, by J. Robert Oppenheimer. Simon and Schuster, New York. 120 pages, \$2.75.

This work by the controversial Director of the Institute for Advanced Study at Princeton and wartime director of the laboratory at Los Alamos permits the reader to discover just what the author's actual beliefs and opinions are.

RADIO RECEIVER DESIGN (second edition), by K. R. Sturley. Part I—Radio Frequency Amplification and Detection. John Wiley & Sons Inc., New York. 667 pages, \$10.00.

This standard work is considerably enlarged in the second edition. It now has 667 pages as against the first edition's 435. Shows evidence of considerable modernization.

PROCEEDINGS OF THE NATIONAL ELECTRONICS CONFERENCE, Volume X. Compiled and published by the National Electronics Conference, Chicago. 831 pages, \$5.00.

A collection of 101 papers covering all subjects in the realm of electronics. Constitutes an important source of authoritative information.

ELECTRONIC ORGANS, by Robert L. Eby. Van Kampen Press, Wheaton, Ill. 213 pages. \$5.00.

Non-technical descriptions of organs made by the six leading manufacturers, with shorter descriptions of a few others. Registration of various models given fully. Little maintenance information and no complete schematics, although a number of partial diagrams are presented. **END**

CORRECTION

In the "Book Reviews" column of the August issue, we inadvertently located Supreme Publications, publishers of *Television Servicing Course*, at an incorrect address. The correct address of the publisher is 1760 Balsam Road, Highland Park, Illinois.

Music everywhere in the home...

University LIESTER APPROVED Loudspeakers

Wrought iron Legs optional

... built into the recreation room bar

... set within a bookcase

... in a furniture headboard

and elsewhere!

Every Room a Music Room... with the **UNIVERSITY** 3-WAY "Companion"

Within the confines of a small enclosure—
performance that spans the complete musical range...
from rich, vibrant bass to lyrical, brilliant highs.

HERE'S HOW:

WOOFER: Heavy Duty exclusive "W" Alnico 5 magnet and rim-centered diaphragm with oversized voice coil on buzz-free duralumin suspension provide exceptional richness and depth of the lowest bass tones.

MID-RANGE: Patented "Diffuser" element comprises dual radial mid-range projector and diffraction ring for efficient full-bodied reproduction of the middle octaves, retaining all the original "presence".

TWEETER: Genuine heavy duty driver unit with exclusive "reciprocating flares" wide angle horn reproduces the full range of the highest musical tones clearly and with true brilliance.

CROSSOVER NETWORK: True electrical separation of high, middle and low frequencies, with professional inductance/capacitance type network results in deep dimensional spatial orchestral quality.

BALANCE CONTROL: Adjusts performance of the system to suit program quality, room acoustics and accommodates a wide gamut of personal taste.

AUTOMATIC CLOCK: Versatile timepiece will plan your musical itinerary—record broadcast programs in your absence—awaken and permit you to retire with choice music by adjusting a simple control and the entire music system, tape recorder or radio will "perform" or "shut off" remotely or automatically.

For latest information write Desk 2

UNIVERSITY LOUDSPEAKERS INC.
80 SOUTH KENSICO AVENUE
WHITE PLAINS, N. Y.

7 RIDER BOOKS JUST PUBLISHED!

ADVANCED TELEVISION SERVICING TECHNIQUES by RETMA Teaching Staff! Tells step-by-step how to service every section of a TV receiver . . . how to use all kinds of test equipment in servicing (sweep generators, signal generators, vacuum tube voltmeters, scopes, ohmmeters).
176 (8 1/2 x 11") pages, soft cover. **Only \$3.60**

LABORATORY WORKBOOK for use with main book—32 (8 1/2 x 11") pp. **Only \$.95**

SPECIALIZED AUTO RADIO MANUALS (Vols. 1-A to 5-A) Complete installation, removal and servicing information on factory-installed car radios (1950-1954) . . . parts lists, schematics, tube layouts, dial stringing.

VOL. 4-A: covers Chrysler, DeSoto, Dodge, Dodge Trucks, Plymouth.

VOL. 5-A: INDEPENDENT CAR MANUFACTURERS—Henry-J, Hudson, Kaiser-Frazer, Nash, Studebaker, Willys.

Vol. 1-A: covers Ford, Lincoln, Mercury

Vol. 2-A: covers Buick, Cadillac, Oldsmobile

Vol. 3-A: covers Chevrolet, Pontiac, GMC Trucks, Chevrolet Trucks

Each 8 1/2 x 11", soft cover.
Vol. 3-A \$1.80; all others \$3.00

COLOR TV DICTIONARY More than a Dictionary! Complete explanation of new color TV terms and definitions—over 50 illustrations. Vital for everyone interested in color TV.

72 (5 1/2 x 8 1/2") pages, soft cover. **Only \$1.25**

R-C and R-L TIME CONSTANT First in a new review series on difficult technical subjects. Covers practical applications of Time Constant and how it affects circuit operation.

48 (5 1/2 x 8 1/2") pages, soft cover. **Only \$.90**

TV FIELD SERVICE MANUAL—Vol. 2 Most marvelous guide to in-the-home servicing—spiral bound, lies flat for easy reference! Troubleshooting, tube layouts, picture adjustment, dial stringing.

VOL. 2 covers Bendix, Capehart, CBS Columbia, Crosley, DuMont. **VOL. 1** covers Admiral, Affiliated Retailers (Artone), Amicee (AMC), Air King, Air Marshall, Allied Purchasing, Andrea, Arvin and Automatic.

VOL. 2—160 (5 1/2 x 8 1/2") pages, soft cover. **Only \$2.40**

VOL. 1—128 (5 1/2 x 8 1/2") pages, soft cover. **Only \$2.10**

OBTAINING AND INTERPRETING TEST SCOPE TRACES Key to successful use of oscilloscope. Covers radio, audio, TV, transmitters. More than 500 waveforms.

Over 140 (5 1/2 x 8 1/2") pages, soft cover. **Only \$2.40**

HOW TO SERVICE TAPE RECORDERS How to troubleshoot and service all kinds of tape recorders. Explains drive mechanisms, recording heads, electronic circuits. Also tells how to set up a tape recorder repair shop.

5 1/2 x 8 1/2" Soft cover. **Only \$2.90**

In Canada, all prices approximately 10% higher.
SEND FOR COMPLETE NEW RIDER CATALOG
Buy these books now from your jobber, bookstore—if not available from these sources, write to:

JOHN F. RIDER PUBLISHER, INC.
480 Canal Street, New York 13, N. Y.

In Canada:
Charles W. Pointon
6 Alcind Ave., Dept. 7,
Toronto, Ontario

Export Agent:
Roburn Agencies, Inc.
39 Warren Street
New York 7, New York

West Coast Office:
4216-20 W. Jefferson Blvd.
Los Angeles, California

Cable Address:
Roburnage N. Y.

ADVERTISING INDEX

Radio-Electronics does not assume responsibility for any errors appearing in the index below.

All Channel Antenna Corp.	96
Alliance Mfg. Co.	Inside Back Cover
Allied Radio Corp.	117
American Phenolic Corp.	134
Amplifier Corporation of America	140
Arkey Radio Kits, Inc.	10
Astron Corp.	144
Atlas Sound Corp.	102
Audel Publishers	125
Audio Fair	156
Barry Electronics Corp.	26
Bell Telephone Labs.	104
Blonder Tongue Labs.	132
Boland & Boyce, Inc.	105
Brach Mfg. Co.	101
Brooks Radio & TV Corp.	100
CBS Mytron (Div. of Columbia Broadcasting System)	9
Capitol Radio Engineering Institute	85
Centralab Division of Globe-Union	141
Century Electronics Co.	18
Channel Master Corp.	141
Chicago Standard Transformer Corp.	154
Christy Trade School	92
Cisin, M. G.	11
Cleveland Institute of Radio-Electronics	97
Coltrush Audio Products Co., Inc.	140
Columbia Electronics Corp.	143
Concord Radio	148
Cornell-Dubilier Electric Corp.	148
Coyne Electrical & TV Radio School	79, 140
Decray, Frank W.	124
DeVry Technical Institute	145
DuMont Electronics Co., Inc.	Inside Front Cover
DuMont Labs., Allen B.	145
Edlle Electronics	122
Electric Sweeper Service	154
Electro Products	106
Electro-Voice	148
Electronic Instrument Co.	32, 119, 138, 154
Electronic Measurements Corp.	136
Elmhurst Radio & TV Service	117
Fenton Co.	120
G & H Wood Products Co.	110
General Commercial Mfg. Co., Inc.	150
General Test Equipment	121
Good, Inc., Don	150
Hallcrafters Co.	126, 128, 130, 132
Heath Co.	67-78, 106, 121, 128, 140, 142, 144
Holtrush Audio Products Co., Inc.	140
ILC	95
Kickoff Electrical Instrument Co.	125
Hudson Specialties Co.	125
Hughes Research & Development Labs.	68
Indiana Technical College	96
Instructorgraph Co.	13
International Correspondence Schools	147
International Rectifier Corp.	91
JFD Manufacturing Co., Inc.	127
Jackson Electrical Instrument Co.	131
Jones & Laughlin Steel Corp.	103
Kay-Townes Antenna Corp.	128
Leotone Radio Corp.	149
Macmillan Co., The	89
Mallory & Co., P. R.	129
Mastertone Electronics	104
McGraw Hill Book Co.	142
Miller Co., J. W.	127
Mosley Electronics	114, 115
Moss Electronic Distributing Co.	87
Musical Masterpiece Society, The	140
National Electronics of Cleveland	3, 27, 28
National Radio Institute	146
National Schools	119
New Jersey Television Supply Co.	88
Opportunity Adlets	138
Perma-Power Co.	119
Permo, Inc.	30, 31
Permotex Corp.	120
Phico Corp.	133
Precision Development Corp.	145
Precision Apparatus Co., Inc.	147
Progressive "Edu-Kits", Inc.	23
Quam Nichols Co.	157
Rainco Mfg. Co.	109
RCA Institutes, Inc.	80, 81
RCA Victor Division (Radio Corp. of America)	Back Cover
Rad-Tel Tube Co.	157
Radiant Corp.	109
Radiart Corp.	80, 81

RADIO SCHOOL DIRECTORY page 153

Baltimore Technical Institute	142
Candler System Co.	21
Capitol Radio Engineering Institute	12
Grantham School of Electronics	117
Indiana Technical College	156
Indianapolis Electronic School	143
Milwaukee School of Engineering	143
RCA Institutes, Inc.	130
Tri-State College	130
Valparaiso Technical Institute	130
Video Specialties	130
Western Television Institute	130
Radio Sound Publications	142
Radio Television Training Association	21
Raytheon Mfg. Co.	12
Rider, Inc., John F.	156
Rinehart & Co., Inc.	122, 124, 130, 143
Rose Co.	130
Sama & Co., Inc., Howard W.	16
Sangamo Electric Co.	95
Scala Radio Co.	148
Service Instruments Co.	149
Simpson Electric Co.	111
Skyline Mfg. Co.	129
Skywelder, Inc.	121
Sonotone Corp.	84
Sootins, Inc.	107
Sprague Products Co.	65
Sprayberry Academy of Radio	102
Stan-Burn Radio & Electronics	118
Standard Wood Products	150
Steve-El Electronics Corp.	135
Supreme Publications	14-15
Sylvania Electric Products	158
Tab	102
Tech-Master Corp.	118
Telltron Electric Co.	118
Transamerica Electronics	138, 144, 149
Transvision, Inc.	150
Triad Transformer Corp.	8
Tung-Sol Electric Corp.	16
Turner Co.	15
University Loud Speakers, Inc.	155
V.A. Enterprises	124
Video Electric Co.	152
Walco Electronics Corp.	123
Webster Electric Corp.	112
Weston Electrical Instrument Co.	24, 85
Windsor Electronic Tube Co.	137
Winegard Co.	22
Wingsaver Mfg. Co.	12
Xcelite, Inc.	151
Zidell Machinery & Supply Co.	128
Zingo Products	119

DIAMONDS OR RHINESTONES?

How many times have you been fooled by cheap, imitation jewelry (or tubes) that looked like the "real" thing?
Too often cheap prices and extravagant claims have fooled the buyer into purchasing these imitations, instead of the genuine article.

Barry Electronics sells first quality, fully guaranteed, individually boxed, STANDARD-BRAND Tubes. Our Tubes do not have to be "set or meter checked" . . . They are from original, sealed cartons from the five leading Tube manufacturers.

Cheap imitations such as seconds, rewashed bargains, and off-brands result in unnecessary call-backs, expenses, and loss of customer good-will.

YOU CAN PLACE YOUR CONFIDENCE IN OUR NEW, FIRST QUALITY, FULLY-GUARANTEED STANDARD-BRAND TUBES.

Ask for **FREE News Bulletin and Handy Order Form**
Tube Orders Over \$25.00, with full remittance, PREPAID to you in U.S.A.

STANDARD BRAND RECEIVING TUBES

—NO REBRANDS • NO SECONDS—

Type	Net	Type	Net	Type	Net
0A2	.95	6AK5GT	.85	7E5	.39
0B2	.85	6B8	.75	7F7	.89
0B3/VR90	.82	6BA6	.70	7FBG	1.25
0C3/VR105	.91	6BC5	.74	7H7	1.00
0D3/VR150	.89	6BE6	.72	7N7	.95
0Z4	.55	6BF5	.94	7Q7	.98
1A7	.77	6BG6	.85	7X7	.90
1B3GT	.90	6BH6	.85	12AT6	.55
1H5GT	.77	6BJ6	.85	12AT7	1.05
1L6	.60	6BK5	.95	12AU6	.65
1L6	.95	6BK7A	1.15	12AU7	.84
1LA6	1.10	6BL7GT	1.20	12AV6	.55
1LB4	1.10	6BN6	1.20	12AV7	1.00
1N34	1.10	6BQ6GT	1.27	12AW6	.88
1N5GT	.95	6BQ7A	1.23	12AX4	.90
1N34A	.55	6BX7GT	1.25	12AX7	.80
1N34B	.70	6BY6	1.25	12BY7	1.17
1R4	.65	6BZ7	1.28	12AZ7	.92
1R5	.75	6C4	.56	12B4	.98
1S5	.75	6C6	.70	12BE6	.75
1T4	.70	6C8	.75	12BD6	.75
1U4	.75	6CD6G	1.80	12BE8	.72
1V5	1.10	6CL6	1.10	12B7	1.00
1V	1.03	6CU6	2.10	12BY7	1.05
1V2	.90	6D6	.75	12BZ7	1.10
1X2B	.90	6F4	3.29	69	.69
1Z2	3.25	6F5	.68	12F5	.70
2A2	.35	6F5GT	.68	12G7	.80
3A4	.59	6F6	.65	12H7	.70
3B7	.39	6FG6	.80	12J7	.58
3Q4	.89	6FG	.85	12K7	.69
3Q5GT	.75	6HG	.52	12N7GT	.85
3L4	.90	6J4(RCA)	4.95	12SQ7GT	.63
3L5	1.10	6J6	.80	12SR7	.70
3AW4	1.50	6J6	.80	12SX7GT	1.10
5R4GY	1.50	6J7	.75	14F7	.75
5U4G	.59	6K6GT	.65	19B6G6	2.05
5V4G	.85	6K7	.50	12B6	1.70
5W4G	.80	6L6	1.10	25B6GT	1.35
5X4G	.75	6L6A	1.10	25L6GT	.70
5Y2GT	.48	6L6GT	1.10	35R5	.70
5Z3	.75	6L7	.80	25Z5	.75
6ARGT	1.10	6M7M	.70	25Z6GT	.64
6A3A	.70	6OZ7	.60	25Z7	1.70
6B7	.95	6S4	.63	26A7GT	4.50
6AC7	1.14	6S7M	.98	26C6	1.25
6A7G	1.85	6S7	.69	26D6	1.15
6AF4	1.39	6S7GT	.88	28D7	1.55
6AG5	.78	65D7GT	.80	35A5	.72
6A6T	1.10	6S7	.66	35R5	.70
6A4GT	.89	6S7	.98	35C5	.72
6AHSGT	.89	6S7J	.65	35L6GT	.70
6A5	.93	6SK7	.65	5U4	.45
6AJ5	1.30	65L7GT	.65	35Z3	.50
6AK5	.80	65N7GT	.79	35Z5GT	.70
6A5-W	1.50	65Q7	.75	35Z6	.70
6AK6	.98	6T4	1.35	50B5	.70
6AL5	.60	6T8	.99	50C5	.72
6AN	1.60	6U8	1.05	51L6GT	.70
6ANS	3.65	6V3A	1.30	80	.6R
6AQ5	.72	6V6GT	.67	81	.75
6A05	.73	6W4GT	.65	83V	1.15
6AS5	.75	6W6GT	.82	84 6Z4	.65
6A56	2.65	6X5GT	.52	11Z3	.75
6A57G	3.75	6X8	1.00	11Z6	1.00
6A6	.58	7A7	.75	16Z0	4.50
6AU4GT	1.00	7A8	.69	5642	1.00
6AUSGT	1.15	7B6	.75	5644	1.75
6A7	.70	7B7	.70	6096	1.85
6AV5GT	1.10	7B8	.78		
6AV6	.57	7C4	.29		
6AX4GT	.84	7C5	.69		

SPECIAL-PURPOSE TUBES

Write for our complete listing of XMTG, Industrial, Special-Purpose and Crystal Diodes. We stock over 2,000 types at excellent prices.

Above is only a partial listing of our huge stock. Types not listed may be ordered at approx. the same savings. Many new special purpose types in stock. We specialize in hard-to-get, obsolete types, which are no longer in production.

AUTHORIZED DISTRIBUTORS
CBS-HYTRON EIMAC WESTINGHOUSE

ORIGINAL JOBBERS' BOXED TUBES IN STOCK—LATE DATES, at WHOLESALE PRICE LEVELS!

TWO-COLORED TUBE CARTONS, with new Safety Partitions. Prevents Tube Breakage. This Super-Gloss Red and Black Carton is the Most Distinctive Box Available Today! Minimum: 100 any one size. Quantity prices on request.

SIZE	Mixture	(6AU6, 6AL5, etc.)	EACH
GT	(6SN7, 6W4, etc.)	.0125	
LARGE GT	(1B3, 6BQ6GT, etc.)	.015	
LARGE GT	(5U4G, 6BQ6, etc.)	.02	

Terms: 25% with order, balance C.O.D.
All merchandise guaranteed. F.O.B., N.Y.C.

BARRY ELECTRONICS CORP.
136-B LIBERTY ST. N. Y. 6, N. Y.
PHONE: REctor 2-2562

RAD-TEL Full Year Guaranteed TUBES

70% TO 90% OFF . . . RAD-TEL TUBES FOR QUALITY, PERFORMANCE, AND DEPENDABILITY

COMPARE! Save More At RAD-TEL On All Parts!

VARIABLE CONDENSERS

Manufactured by Philco, Radio Condenser, etc. 2 Gang AM and FM; No. 9 Each 89c. Lots of 3 79c.



Contains 2 separate sections for AM and 2 for FM with padded condensers. With attached slug-tuned high frequency coil whose plunger is geared to condenser shaft. Pulley type drive wheel.
2 Gang AM, 3 Gang FM No. 10, equipped with drum pulley and padders. Each 89c. Lots of 3 79c.
3 Gang AM Superhet No. 12, complete with padders and pulley type drive wheel. Each 89c. Lots of 3 79c.

NO. 132—CATHODE RAY TUBE REJUVENATOR



Fits all makes of picture tubes. Completely automatic. Easy to install, no tools needed. For AC parallel circuits. Your Old Picture Tubes Are Still Useful. List price—\$5.95. Each \$1.29
Lots of 10 \$1.09

Type	Price	Type	Price	Type	Price	Type	Price
OA2	.74	6AU6	.46	7A4	.47	14A4	.69
OA4	.68	6AV5GT	.83	7A5	.59	14A5	.59
OB2	.81	6AV6	.40	7A6	.69	14A7	.63
OC3	.72	6AX4GT	.65	7A7	.69	14AF7	.59
OD3	.70	6B4	.54	7A8	.68	14B6	.63
OZ4M	.65	6BA6	.49	7AD7	.79	14B8	.63
1A5	.49	6BA7	.57	7AF7	.53	14C5	.79
1A7GT	.47	6BC5	.54	7AG7	.69	14C7	.79
1A2	.62	6BD5	.59	7AH7	.79	14E6	.75
1B3GT	.73	6BD6	.45	7B4	.44	14E7	.88
1C5	.43	6BE6	.51	7B5	.45	14F7	.65
1G6	.24	6BF5	.41	7B6	.69	14F8	.69
1H4	.30	6BF6	.37	7B7	.49	14H7	.59
1H5GT	.49	6BG6G	1.25	7C4	.59	14J7	.30
1L4	.46	6BH6	.53	7C5	.69	14N7	.84
1LA4	.59	6BJ6	.49	7C6	.59	14R7	.79
1LA6	.69	6BK5	.80	7E5	.59	14S7	.89
1LC5	.59	6BK7	.80	7E6	.30	14W7	.30
1LC6	.79	6BL7GT	.83	7E7	.59	14X7	.69
1LD5	.59	6BN6	.59	7F7	.79	14Y7	.62
1LE3	.59	6BQ6GT	.98	7F8	.79	19B6G6	1.39
1LG5	.69	6BQ7	.90	7G7	.89	19T8	.69
1LH4	.69	6BZ7	.90	7H7	.59	19V8	.79
1LN5	.59	6C4	.40	7J7	.79	24A	.39
1NSGT	.67	6C5	.39	7K7	.69	25AV5GT	.83
1Q5GT	.58	6C6	.58	7L7	.59	25BQ6GT	.98
1R5	.62	6CB6	.54	7N7	.69	25L6GT	.51
1S4	.59	6CD6	1.11	7Q7	.66	25W4GT	.59
1S5	.51	6CF6	.64	7R7	.89	25Z5	.66
1T4	.58	6CS6	.51	7S7	.79	25Z6	.49
1T5	.59	6D6	.59	7V7	.89	26	.45
1U4	.57	6E5	.48	7X6	.54	27	.39
1U5	.50	6F5GT	.39	7X7	.70	32L7	.89
1V	.43	6F6	.59	7Y4	.69	35A5	.58
1X2A	.63	6G6	.42	7Z4	.59	35B5	.52
2A3	.30	6H6GT	.41	12A6	.54	35C5	.51
2X2	.49	6J5GT	.43	12A8GT	.61	35L6GT	.51
3A4	.45	6J6	.52	12AL5	.37	35W4	.47
3E5	.46	6J7	.43	12AQ5	.52	35Y4	.54
3L4	.69	6K5	.47	12AT6	.41	35Z3	.59
3Q4	.48	6K6GT	.45	12AT7	.72	35Z4	.47
3Q5GT	.69	6K7	.44	12AU6	.46	35Z5GT	.47
3S4	.58	6L6	.64	12AU7	.60	45	.55
3V4	.58	6L7M	.68	12AV6	.39	45Z5	.49
5A2A	.59	6N7M	.63	12AV7	.73	46	.69
5T4	.79	6Q7	.65	12AX4	.67	50A5	.55
5U4G	.55	6R7	.49	12AX7	.63	50B5	.52
5W4GT	.50	6S4	.48	12AY7	.69	50C5	.51
5Y3GT	.37	6S7M	1.69	12AZ7	.59	50L6GT	.61
5Y4	.51	6S7M	.79	12BA6	.49	50X6	.49
5Z3	.45	6S8GT	.53	12BA7	.60	50Y6	.49
6A6	.51	6SA7GT	.55	12BD6	.45	50Y7	.50
6A7	.69	6SD7GT	.41	12BE6	.51	55	.49
6AB4	.44	6SF5GT	.46	12BF6	.39	56	.49
6AC5	.69	6SG7GT	.41	12BH7	.63	57	.58
6AC7M	.86	6SH7GT	.49	12BY7	.65	70L7	.97
6AF4	.90	6SJ7GT	.41	12BZ7	.65	75	.49
6AG5	.56	6SK7GT	.53	12H6	.56	76	.44
6AG7M	.99	6SL7GT	.48	12J5	.42	77	.57
6AH4	.57	6SN7GT	.59	12J7	.49	78	.47
6AH6	.73	6SQ7GT	.46	12K8	.59	80	.43
6AJ5	.65	6SR7GT	.45	12Q7	.59	83V	.68
6AK5	.55	6SS7GT	.42	12S8GT	.62	84/6Z4	.46
6AK6	.59	6T4	.99	12SA7GT	.65	85	.59
6AL5	.42	6T8	.80	12SF5	.50	117L7	.99
6AM8	.78	6U6	.59	12SG7	.51	117P7	.99
6AQ5	.50	6U8	.78	12SJ7M	.67	117Z3	.37
6AQ6	.37	6V6GT	.50	12SK7GT	.63	117Z6	.69
6AQ7	.70	6W4GT	.47	12SL7GT	.57	807	.99
6AR5	.45	6W6GT	.57	12SN7GT	.52	866A	1.39
6AS5	.50	6X4	.37	12SQ7GT	.56	Hi-Po	
6AT6	.41	6X5GT	.37	12SR7M	.49	#567	1.39
6AU4GT	.68	6X8	.75	12V6GT	.46		
		6Y6G	.48	12X4	.38		

NO. 75—ARMY-NAVY HEADSETS



Individually boxed. Very sensitive. Meet both Army and Navy specifications. List Price \$16.00. \$2.95 each per set
Lots of 3 \$2.83 each

WAFFER ROTARY SWITCH KITS



A choice combination of single, double, etc., from 2 to 8 positions. Special Kit of 10 \$1.39
Lots of 3 Kits \$1.29

NO. 107 DOUBLE FLYBACK TTR-172



Up to 13.5KV output. RCA type horizontal deflection transformer with two filament windings for voltage doubler operation. First time at this low price.
\$1.89 each. Lots of 3 \$1.79

NO. 125 PHILCO TV BOOSTER



Completely self-contained, including 2 6J6 tubes for high channels and 1 for low channels and selenium rectifier. Plastic cabinet in factory-sealed cartons, complete with instructions.
Model TB-3 \$9.95

RCA TYPE FLYBACK TRANSFORMER

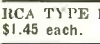

\$1.45 each. Lots of 3 \$1.35

NO. 46—HI-VOLTAGE R.F. COIL 4500 VOLTS RF TRANSFORMER



Ideal for TV and Oscilloscope power supplies, using 5" to 7" tubes. This buy is too BIG to be beaten! List price—\$7.50
79c Each
Lots of 3 69c Each

NO. 97—WEN SOLDERING GUN

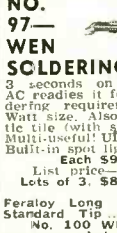

3 seconds on 120 Volt AC readies it for any soldering requirement. 250 Watt size. Also cuts plastic tile (with special tip). Multi-useful! UL Approved. Built-in spot light.
Each \$9.71
List price—\$12.95
Lots of 3 \$8.64 Each
TIPS
Feraloy Long Life.....35c each
Standard Tip.....11c each
No. 100 WEN POLISHER \$9.00 each
Lots of 3 \$8.75 each

All New Parts At Old Fashioned SAVINGS!

SPEAKERS All Standard Brands Dynamic + PM



Size	Ohms	Price	Lots of 5
5"x7"	1000	99c	+89c
5"x7"	1800	99c	89c
5"x7"	2750	99c	89c
6"	90	1.49	1.29
8"	680	1.95	1.70
(with 6K8 output transformer)			
6.5"	38	1.49	1.29
5"	1.47 oz.	1.95	1.70
(with 50L6 output transformer)			
4"	.68 oz.	1.89	1.64
(with 50L6 output transformer)			
8"	2.15 oz.	2.95	2.65
10"	2.15 oz.	3.95	3.60

NO. 3—VERTICAL OUTPUT TRANSFORMER



Very popular, used in most TV sets. Well-known manufacturer. Matches vertical output tube to the deflection yoke, 10 to 1 ratio. A terrific buy on a top performer. List Price—\$4.50.
95c each
Lots of 5 90c each

NO. 133. Electrolytic Condensers



Assorted condensers, consists of single, double, triple and quadruple. All popular voltages and capacities. All standard popular brands.
Kit of 10
\$2.39

NO. 81. ANODE CAPS

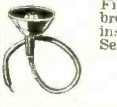

Fits all TV sets. Phosphor bronze metal plug with rubber insulator and high voltage lead. Seize this buy NOW!
List price—75c
19c each
Lots of 10 18c each

NO. 53 BIAS CONDENSERS



500 MFD 12 V. Mfd. by leading companies. List price—\$2.00. Maximum value in minimum space. A buy you've been looking for!
35c each
Kit of 10
\$2.95 each

NO. 15 RESISTORS



(ASSORTMENT OF 200 Standard RTMA Coded or Value Printed. Uninsulated. 1/2 Watt, 1 Watt, 2 Watt and some 10 Watt.)
List Price: \$10.00—
\$1.39
Lots of 10 Kits 99c each

NO. 106—DOUBLE SHELL TYPE POWER TRANSFORMER



No. J184 PRI. 117V. Sec. 286V. 300 ma; 5v, 6 AMPS; 6.3V, 1.5 AMPS; 0.4V, 4.4 AMPS.
\$3.50 each

JAN TUBES

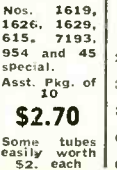

Nos. 1619, 1626, 1629, 615, 7193, 954 and 45 special.
Asst. Pkg. of 10
\$2.70
Some tubes easily worth \$2. each

Additional Tube Buys!	
1E7	.29
1LB4	.89
1P5GT	.57
2W3	.38
3B7	.27
3D6	.27
6AS6	1.49
6AU5GT	.32
6U5	.57
12B4	.60
12C8M	.34
12SCTM	.63
35	.58
36	.39
58	.60
1274	.30

RAD-TEL TUBE CO.

Dept. RE-9
115 Coit St., Irvington 11, N. J. "Integrity Is Our Chief Asset"

TERMS: A 25% deposit must accompany all orders—balance C.O.D. All shipments F.O.B. Irvington warehouse. ORDERS UNDER \$10—\$1.00 HANDLING CHARGE. Subject to Prior sale.

PLEASE: Send full remittance with postage and save C.O.D. charges! We refund all unused money!

Phone: Essex 5-2947

Tubes in Bold Type Cover 90% of Demand

SELENIUM RECTIFIERS

We specialize in Rectifiers, Power supplies to specifications. Immediate delivery.

Curr. Cont.	18/14	36.28	130/100	266/217
1AMP	1.40	4.00	8.50	22.25
2AMP	2.10	3.00	10.50	28.25
4AMP	3.75	5.25	18.50	38.50
6AMP	5.50	9.00	33.00	54.85
10AMP	6.60	12.75	42.50	84.85
12AMP	8.20	16.25	46.00	90.00
20AMP	13.25	25.50	73.50	160.85
24AMP	16.25	32.50	86.50	190.85
30AMP	20.00	38.00	121.50	235.85
36AMP	25.00	48.50	158.50	295.85
50AMP	32.00	62.50	189.75	405.85
100AMP	60.00	120.00	380.75	795.85

Rectifier & Transformer
115V/60 cy inputs.

up to 14VDC at 12 Amps \$ 19.98
up to 28VDC at 4 Amps 14.98
up to 28VDC at 12 Amps 29.98
up to 28VDC at 24 Amps 63.98
up to 28VDC at 50 Amps 127.00

WRITE FOR POWER RECTIFIER CATALOG

HIGH CURRENT PWR SUPPLIES

Variable 0-28VDC. Completely Built, Ready to Go. Full Wave Selenium Rectifier, Transformer, Variac, Volt & Amp Meters, Switch, Terminals & Fuse. In Dry Dry Cabinet. Standard 115V 60 cy input. 220V or order. Write!

Stock Number	Continuous Rating	With Meters
T28V5A	0-28VDC 5 Amp.	\$47.95
T28V12A	0-28VDC at 12 Amp	89.00
T28V24A	0-28VDC at 24 Amp	129.50
T28V50A	0-28VDC at 50 Amp	239.50

RECTIFIER XFMRs

Primary	115V 60 Cvc
Secondary	0-9-12-18-28-36V
4 Amp	5.875; 2/\$19.75
12 Amp	\$16.75; 2/\$29.95
18 Amp	\$35.75; 2/\$69.95
18 Volt, 2 Amps	\$2.25; 2/\$4.50

RECTIFIER CHOKES

CH07/4AMP/07HV/6R/10	\$7.95
CH01/12AMP/01HV/1R/12	\$14.95
CH004/24A/004HV/025R/20	\$29.95

TUBES

*From This Special List We Ship \$10.00 and Up Tube Orders At Our Expense (Post-paid) Within Continental Limits of U.S.A. Day Gtd. When ordering mention 9RE

0A20.84	6AQ552
0A3 VR751.04	6AQ618
0B3 VR9096	6AR63.27
0C3 VR10592	6AS57.79
0D3 VR15084	6AS65.67
1B3 801680	6AS7G3.48
1L448	6AT65.4
1L61.08	6AU61.10
1L578	6AV5GT96
1P51.5	6AV64.95
1R41.29	6AX4/6U47.4
1R51.49	6B4C1.18
1U452	6B7A1.09
1U554	6B7C1.63
2A4G1.2	6BD68.3
2X24.2	6BD6G8.3
3R4GY1.20	6BE65.6
5R4GYW1.48	6BE6G5.6
5U4G55	6BM66.3
5X4G75	6BQ61.58
6AC760	6BK71.58
6AC571	6BL7GT1.19
6AH61.14	6BD6GT1.20
6AJ51.40	6BQ71.65
6AK587	6C45.6
6AK692	6C55.6
6AL584	6CB65.9
6AL7GT98	6DA2.70
6AN53.27	6F6GT7.9

TUBE SOCKETS

CINCH-JOHNSON-AMPH

Octal (low-loss mica) ring mtg.12 for 2.00
each 12c; 2 for \$3.0015 for 1.00
Octal (mica) ring mtg. 12/5112 for 1.00
Octal (sealite) ring mtg.12 for 2.00
Octal (bakelite) saddle mtg.12 for 1.00
Octal (mica) saddle mtg.12 for 1.00
Octal (sealite) saddle mtg.12 for 1.00
7 pin min (mica) bottom mtg.12 for 1.00
7 pin min (mica) bottom mtg.12 for 1.00
7 pin min (mica) bottom mtg.12 for 1.00
9 pin min (mica) bottom mtg.12 for 1.00
9 pin min (mica) bottom mtg.12 for 1.00
9 pin min (mica) bottom mtg.12 for 1.00

TUBE SOCKETS

CINCH-JOHNSON-AMPH

Octal (low-loss mica) ring mtg.12 for 2.00
each 12c; 2 for \$3.0015 for 1.00
Octal (mica) ring mtg. 12/5112 for 1.00
Octal (sealite) ring mtg.12 for 2.00
Octal (bakelite) saddle mtg.12 for 1.00
Octal (mica) saddle mtg.12 for 1.00
Octal (sealite) saddle mtg.12 for 1.00
7 pin min (mica) bottom mtg.12 for 1.00
7 pin min (mica) bottom mtg.12 for 1.00
7 pin min (mica) bottom mtg.12 for 1.00
9 pin min (mica) bottom mtg.12 for 1.00
9 pin min (mica) bottom mtg.12 for 1.00
9 pin min (mica) bottom mtg.12 for 1.00

TUBE SOCKETS

CINCH-JOHNSON-AMPH

Octal (low-loss mica) ring mtg.12 for 2.00
each 12c; 2 for \$3.0015 for 1.00
Octal (mica) ring mtg. 12/5112 for 1.00
Octal (sealite) ring mtg.12 for 2.00
Octal (bakelite) saddle mtg.12 for 1.00
Octal (mica) saddle mtg.12 for 1.00
Octal (sealite) saddle mtg.12 for 1.00
7 pin min (mica) bottom mtg.12 for 1.00
7 pin min (mica) bottom mtg.12 for 1.00
7 pin min (mica) bottom mtg.12 for 1.00
9 pin min (mica) bottom mtg.12 for 1.00
9 pin min (mica) bottom mtg.12 for 1.00
9 pin min (mica) bottom mtg.12 for 1.00

TUBE SOCKETS

CINCH-JOHNSON-AMPH

Octal (low-loss mica) ring mtg.12 for 2.00
each 12c; 2 for \$3.0015 for 1.00
Octal (mica) ring mtg. 12/5112 for 1.00
Octal (sealite) ring mtg.12 for 2.00
Octal (bakelite) saddle mtg.12 for 1.00
Octal (mica) saddle mtg.12 for 1.00
Octal (sealite) saddle mtg.12 for 1.00
7 pin min (mica) bottom mtg.12 for 1.00
7 pin min (mica) bottom mtg.12 for 1.00
7 pin min (mica) bottom mtg.12 for 1.00
9 pin min (mica) bottom mtg.12 for 1.00
9 pin min (mica) bottom mtg.12 for 1.00
9 pin min (mica) bottom mtg.12 for 1.00

TUBE SOCKETS

CINCH-JOHNSON-AMPH

Octal (low-loss mica) ring mtg.12 for 2.00
each 12c; 2 for \$3.0015 for 1.00
Octal (mica) ring mtg. 12/5112 for 1.00
Octal (sealite) ring mtg.12 for 2.00
Octal (bakelite) saddle mtg.12 for 1.00
Octal (mica) saddle mtg.12 for 1.00
Octal (sealite) saddle mtg.12 for 1.00
7 pin min (mica) bottom mtg.12 for 1.00
7 pin min (mica) bottom mtg.12 for 1.00
7 pin min (mica) bottom mtg.12 for 1.00
9 pin min (mica) bottom mtg.12 for 1.00
9 pin min (mica) bottom mtg.12 for 1.00
9 pin min (mica) bottom mtg.12 for 1.00

TUBE SOCKETS

CINCH-JOHNSON-AMPH

Octal (low-loss mica) ring mtg.12 for 2.00
each 12c; 2 for \$3.0015 for 1.00
Octal (mica) ring mtg. 12/5112 for 1.00
Octal (sealite) ring mtg.12 for 2.00
Octal (bakelite) saddle mtg.12 for 1.00
Octal (mica) saddle mtg.12 for 1.00
Octal (sealite) saddle mtg.12 for 1.00
7 pin min (mica) bottom mtg.12 for 1.00
7 pin min (mica) bottom mtg.12 for 1.00
7 pin min (mica) bottom mtg.12 for 1.00
9 pin min (mica) bottom mtg.12 for 1.00
9 pin min (mica) bottom mtg.12 for 1.00
9 pin min (mica) bottom mtg.12 for 1.00

TUBE SOCKETS

CINCH-JOHNSON-AMPH

Octal (low-loss mica) ring mtg.12 for 2.00
each 12c; 2 for \$3.0015 for 1.00
Octal (mica) ring mtg. 12/5112 for 1.00
Octal (sealite) ring mtg.12 for 2.00
Octal (bakelite) saddle mtg.12 for 1.00
Octal (mica) saddle mtg.12 for 1.00
Octal (sealite) saddle mtg.12 for 1.00
7 pin min (mica) bottom mtg.12 for 1.00
7 pin min (mica) bottom mtg.12 for 1.00
7 pin min (mica) bottom mtg.12 for 1.00
9 pin min (mica) bottom mtg.12 for 1.00
9 pin min (mica) bottom mtg.12 for 1.00
9 pin min (mica) bottom mtg.12 for 1.00

TUBE SOCKETS

CINCH-JOHNSON-AMPH

Octal (low-loss mica) ring mtg.12 for 2.00
each 12c; 2 for \$3.0015 for 1.00
Octal (mica) ring mtg. 12/5112 for 1.00
Octal (sealite) ring mtg.12 for 2.00
Octal (bakelite) saddle mtg.12 for 1.00
Octal (mica) saddle mtg.12 for 1.00
Octal (sealite) saddle mtg.12 for 1.00
7 pin min (mica) bottom mtg.12 for 1.00
7 pin min (mica) bottom mtg.12 for 1.00
7 pin min (mica) bottom mtg.12 for 1.00
9 pin min (mica) bottom mtg.12 for 1.00
9 pin min (mica) bottom mtg.12 for 1.00
9 pin min (mica) bottom mtg.12 for 1.00

TUBE SOCKETS

CINCH-JOHNSON-AMPH

Octal (low-loss mica) ring mtg.12 for 2.00
each 12c; 2 for \$3.0015 for 1.00
Octal (mica) ring mtg. 12/5112 for 1.00
Octal (sealite) ring mtg.12 for 2.00
Octal (bakelite) saddle mtg.12 for 1.00
Octal (mica) saddle mtg.12 for 1.00
Octal (sealite) saddle mtg.12 for 1.00
7 pin min (mica) bottom mtg.12 for 1.00
7 pin min (mica) bottom mtg.12 for 1.00
7 pin min (mica) bottom mtg.12 for 1.00
9 pin min (mica) bottom mtg.12 for 1.00
9 pin min (mica) bottom mtg.12 for 1.00
9 pin min (mica) bottom mtg.12 for 1.00

TUBE SOCKETS

CINCH-JOHNSON-AMPH

Octal (low-loss mica) ring mtg.12 for 2.00
each 12c; 2 for \$3.0015 for 1.00
Octal (mica) ring mtg. 12/5112 for 1.00
Octal (sealite) ring mtg.12 for 2.00
Octal (bakelite) saddle mtg.12 for 1.00
Octal (mica) saddle mtg.12 for 1.00
Octal (sealite) saddle mtg.12 for 1.00
7 pin min (mica) bottom mtg.12 for 1.00
7 pin min (mica) bottom mtg.12 for 1.00
7 pin min (mica) bottom mtg.12 for 1.00
9 pin min (mica) bottom mtg.12 for 1.00
9 pin min (mica) bottom mtg.12 for 1.00
9 pin min (mica) bottom mtg.12 for 1.00

TUBE SOCKETS

CINCH-JOHNSON-AMPH

Octal (low-loss mica) ring mtg.12 for 2.00
each 12c; 2 for \$3.0015 for 1.00
Octal (mica) ring mtg. 12/5112 for 1.00
Octal (sealite) ring mtg.12 for 2.00
Octal (bakelite) saddle mtg.12 for 1.00
Octal (mica) saddle mtg.12 for 1.00
Octal (sealite) saddle mtg.12 for 1.00
7 pin min (mica) bottom mtg.12 for 1.00
7 pin min (mica) bottom mtg.12 for 1.00
7 pin min (mica) bottom mtg.12 for 1.00
9 pin min (mica) bottom mtg.12 for 1.00
9 pin min (mica) bottom mtg.12 for 1.00
9 pin min (mica) bottom mtg.12 for 1.00

TUBE SOCKETS

CINCH-JOHNSON-AMPH

Octal (low-loss mica) ring mtg.12 for 2.00
each 12c; 2 for \$3.0015 for 1.00
Octal (mica) ring mtg. 12/5112 for 1.00
Octal (sealite) ring mtg.12 for 2.00
Octal (bakelite) saddle mtg.12 for 1.00
Octal (mica) saddle mtg.12 for 1.00
Octal (sealite) saddle mtg.12 for 1.00
7 pin min (mica) bottom mtg.12 for 1.00
7 pin min (mica) bottom mtg.12 for 1.00
7 pin min (mica) bottom mtg.12 for 1.00
9 pin min (mica) bottom mtg.12 for 1.00
9 pin min (mica) bottom mtg.12 for 1.00
9 pin min (mica) bottom mtg.12 for 1.00

TUBE SOCKETS

CINCH-JOHNSON-AMPH

Octal (low-loss mica) ring mtg.12 for 2.00
each 12c; 2 for \$3.0015 for 1.00
Octal (mica) ring mtg. 12/5112 for 1.00
Octal (sealite) ring mtg.12 for 2.00
Octal (bakelite) saddle mtg.12 for 1.00
Octal (mica) saddle mtg.12 for 1.00
Octal (sealite) saddle mtg.12 for 1.00
7 pin min (mica) bottom mtg.12 for 1.00
7 pin min (mica) bottom mtg.12 for 1.00
7 pin min (mica) bottom mtg.12 for 1.00
9 pin min (mica) bottom mtg.12 for 1.00
9 pin min (mica) bottom mtg.12 for 1.00
9 pin min (mica) bottom mtg.12 for 1.00

TUBE SOCKETS

CINCH-JOHNSON-AMPH

Octal (low-loss mica) ring mtg.12 for 2.00
each 12c; 2 for \$3.0015 for 1.00
Octal (mica) ring mtg. 12/5112 for 1.00
Octal (sealite) ring mtg.12 for 2.00
Octal (bakelite) saddle mtg.12 for 1.00
Octal (mica) saddle mtg.12 for 1.00
Octal (sealite) saddle mtg.12 for 1.00
7 pin min (mica) bottom mtg.12 for 1.00
7 pin min (mica) bottom mtg.12 for 1.00
7 pin min (mica) bottom mtg.12 for 1.00
9 pin min (mica) bottom mtg.12 for 1.00
9 pin min (mica) bottom mtg.12 for 1.00
9 pin min (mica) bottom mtg.12 for 1.00

TUBE SOCKETS

CINCH-JOHNSON-AMPH

Octal (low-loss mica) ring mtg.12 for 2.00
each 12c; 2 for \$3.0015 for 1.00
Octal (mica) ring mtg. 12/5112 for 1.00
Octal (sealite) ring mtg.12 for 2.00
Octal (bakelite) saddle mtg.12 for 1.00
Octal (mica) saddle mtg.12 for 1.00
Octal (sealite) saddle mtg.12 for 1.00
7 pin min (mica) bottom mtg.12 for 1.00
7 pin min (mica) bottom mtg.12 for 1.00
7 pin min (mica) bottom mtg.12 for 1.00
9 pin min (mica) bottom mtg.12 for 1.00
9 pin min (mica) bottom mtg.12 for 1.00
9 pin min (mica) bottom mtg.12 for 1.00

TUBE SOCKETS

CINCH-JOHNSON-AMPH

Octal (low-loss mica) ring mtg.12 for 2.00
each 12c; 2 for \$3.0015 for 1.00
Octal (mica) ring mtg. 12/5112 for 1.00
Octal (sealite) ring mtg.12 for 2.00
Octal (bakelite) saddle mtg.12 for 1.00
Octal (mica) saddle mtg.12 for 1.00
Octal (sealite) saddle mtg.12 for 1.00
7 pin min (mica) bottom mtg.12 for 1.00
7 pin min (mica) bottom mtg.12 for 1.00
7 pin min (mica) bottom mtg.12 for 1.00
9 pin min (mica) bottom mtg.12 for 1.00
9 pin min (mica) bottom mtg.12 for 1.00
9 pin min (mica) bottom mtg.12 for 1.00

"TAB"

THAT'S A BUY

BARGAINS-BARGAINS

Just off the press, "TAB" Scoop Sheet. Tools, Portable Radios, Photos, Audio Equip., Radio Parts & Equipment. All items way below usual bargain prices. Write for the "TAB" Scoop Sheet.

ALLIANCE first with AUTOMATIC GARAGE DOOR OPERATOR

THAT'S PRICED LOW FOR THE MASS MARKET

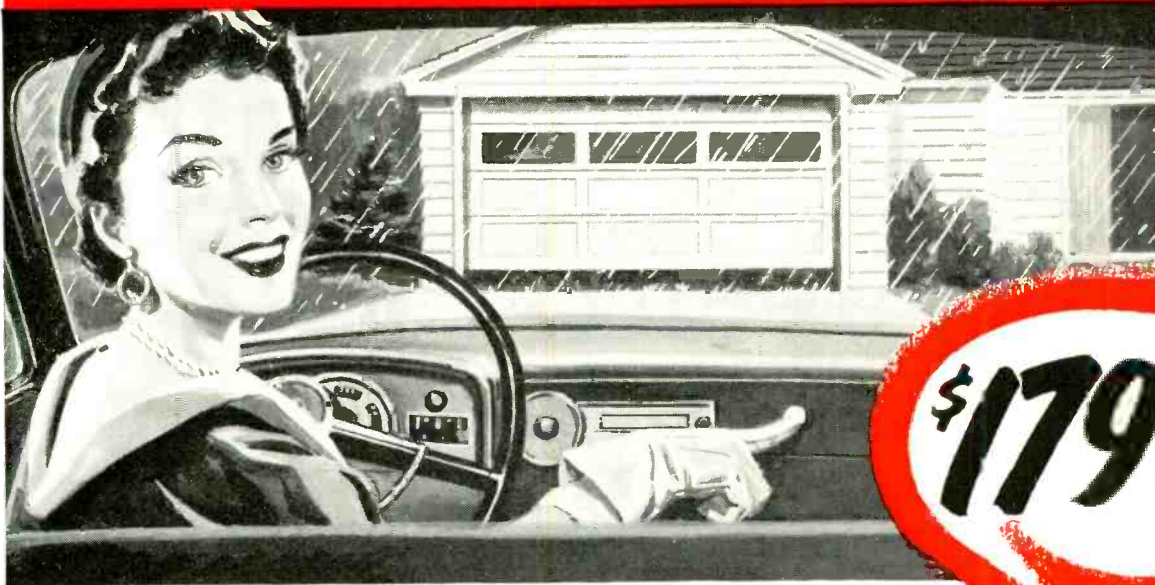

\$179⁹⁵

OFF-SEASON PROFITS FOR TV DEALERS

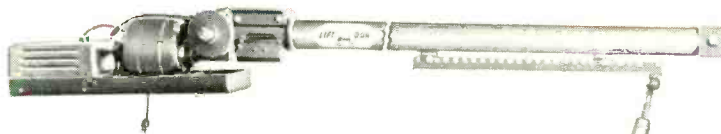

THE ELECTRONIC **LIFT-A-DOR**

OPENS • CLOSSES • LOCKS GARAGE DOORS
Automatically. A RADIO-CONTROLLED "NATURAL"
FOR RADIO AND TV SERVICE DEALERS AND INSTALLERS!

More than 15,000,000 homes are prospects!

Fast—Easy Installation—Alliance Lift-A-Dor Is a Packaged,
Quality, Low Priced Unit. Fits Nearly All Overhead Doors
—Takes Only Ordinary Tools and 'Know How' To Install.

**AVOID SEASONAL SLUMPS WITH THE
ELECTRONIC ALLIANCE LIFT-A-DOR!**

AMAZING LOW PRICE!

The first dependable fool proof garage door operator, fully guaranteed at a price all can afford! A real convenience—a protective necessity that saves work—simply push a button!

TV DEMONSTRATIONS!

Alliance TV spots like those making Alliance Tenna-Rotor famous, will show and demonstrate Lift-A-Dor to millions of TV viewers.

Newspapers—magazines—point-of-sale displays pre-sell!

WRITE THE FACTORY FOR FACTS!

A radio impulse transmitter in car, operated by push-button on dash is pre-tuned to receiver in garage which raises or lowers door automatically—locks, unlocks and turns on light. Installation takes no digging—no outdoor wiring, no special tools. Write for catalog and complete information.

THE **ALLIANCE** MANUFACTURING CO. • ALLIANCE, OHIO

Makers of the Famous Alliance Tenna-Rotor

BRUNO MATAS 3-56
20 EVERETT ST.
LAWRENCE MASS

ook alike...



...but what a difference!

These RCA types today give you ...

LONGER LIFE



SUPERIOR PERFORMANCE

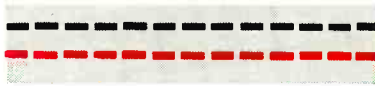

AT NO EXTRA COST



Here are 3 more examples of how regular RCA receiving tubes are constantly being improved to meet the changing requirements of radio and television applications. These RCA types provide you with the superior performance usually claimed for higher priced specialty designed types.

RCA-6J6 features pure tungsten heaters for improved life . . . uses a special cathode material to help maintain characteristics throughout the life of the tube. Each tube mount is adjusted to provide increased uni-

formity of characteristics of each triode unit.

RCA-6CB6 uses a No. 2 grid of improved design, resulting in lower grid operating temperature and longer tube life. Special controls on materials and processing improve uniformity of plate cutoff and reduce variations in characteristics when heater voltage fluctuates.

RCA-6AU6 uses a double helical heater, resulting in an extremely low hum level. Inverted pinched cathode reduces possible motion of tube ele-

ments thus minimizing microphonics.

The superior performance of *regular* RCA receiving tubes—at *regular* prices—eliminates unnecessary call-backs, assures you of greater customer satisfaction, results in increased profits for you.



When you sell a receiving tube, your reputation and profit depend on its *performance* and *reliability*. So, you can't afford to buy anything less than the best in receiving tubes . . . and the best are RCA.



RADIO CORPORATION of AMERICA
ELECTRON TUBES

HARRISON, N. J.

ADV Plans, LLC

Copyright Notice:

The entire contents of this CD/DVD are copyright 2014 by ADV Plans, LLC. All Rights Reserved.

Reproduction or distribution of this disk, either free or for a fee is strictly prohibited. We actively monitor and remove listings on eBay thru Vero.

You are free to copy or use individual images in your own projects, magazines, brochures or other school projects.

Only the sellers listed here are authorized distributors of this collection:
www.theclassicarchives.com/authorizedsuppliers

Please view our other products at
www.theclassicarchives.com,
or our ebay stores:

[TheClassicArchives](#)
[ADVPlans](#)
[SuperShedPlans](#)

